



---

# Introduction to WebPACK 4.1 for FPGAs

---

Using Xilinx WebPACK Software to Create  
FPGA Designs for the XSA Board

All XS-prefix product designations are trademarks of XESS Corp.

All XC-prefix product designations are trademarks of Xilinx.

## Table of Contents

What This Is and <i>Is Not</i> .....	1
FPGA Programming .....	3
Installing WebPACK .....	5
Getting WebPACK .....	5
Installing WebPACK.....	9
Getting XSTOOLS .....	9
Installing XSTOOLS.....	10
Our First Design.....	11
An LED Decoder .....	11
Starting WebPACK Project Navigator .....	13
Describing Your Design With VHDL.....	19
Checking the VHDL Syntax.....	26
Fixing VHDL Errors .....	27
Synthesizing the Logic circuitry for Your Design.....	30
Implementing the Logic Circuitry in the FPGA.....	31
Checking the Implementation.....	33
Constraining the Fit.....	34
Viewing the Chip .....	39
Generating the Bitstream .....	46
Downloading the Bitstream .....	48
Testing the Circuit .....	50
Hierarchical Design .....	52
A Displayable Counter.....	52
Starting a New Design .....	53
Adding the LED Decoder.....	54

Adding a Counter .....	57
Tying Them Together.....	62
Checking the VHDL Syntax.....	93
Constraining the Design.....	94
Synthesizing the Logic Circuitry for the Design .....	96
Implementing the Logic Circuitry in the FPGA.....	97
Checking the Implementation.....	97
Checking the Timing .....	99
Generating the Bitstream .....	102
Downloading the Bitstream .....	106
Testing the Circuit.....	111
Going Further... ..	112

# 0

---

## What This Is and *Is Not*

There are numerous requests on newgroups that go something like this:

"I am new to using programmable logic like FPGAs and CPLDs. How do I start? Is there a tutorial and some free tools I can use to learn more?"

Xilinx has released their WebPACK on the web so that anyone can download a free set of tools for CPLD and FPGA-based logic designs. And XESS Corp. has written this tutorial that attempts to give you a gentle introduction to using the WebPACK tools. (Other programmable logic manufacturers have also released free toolsets. Someone else will have to write a tutorial for them.)

This tutorial shows the use of the WebPACK tools on two simple design examples: 1) an LED decoder and 2) a counter which displays its current value on a seven-segment LED. Along the way, you will see:

- How to start an FPGA project.
- How to target a design to a particular type of FPGA.
- How to describe a logic circuit using VHDL and/or schematics.
- How to detect and fix VHDL syntactical errors.
- How to synthesize a netlist from a circuit description.
- How to fit the netlist into an FPGA.
- How to check device utilization and timing for an FPGA.
- How to generate a bitstream for an FPGA.
- How to download a bitstream to program an FPGA.
- How to test the programmed FPGA.

That said, it is important to say what this tutorial will not teach you:

- It will not teach you how to design logic with VHDL.
- It will not teach you how to choose the best type of FPGA or CPLD for your design.
- It will not teach you how to arrange your logic for the most efficient use of the resources in an FPGA.
- It will not teach you what to do if your design doesn't fit in a particular FPGA.
- It will not show you every feature of the WebPACK software and discuss how to set every option and property.

In short, this is just a tutorial to get you started using the Xilinx WebPACK FPGA tools. After you go through this tutorial you should be able to move on to more advanced topics.

# 1

---

# FPGA Programming

Implementing a logic design with an FPGA usually consists of the following steps (depicted in the figure which follows):

1. You enter a description of your logic circuit using a *hardware description language* (HDL) such as VHDL or Verilog. You can also draw your design using a schematic editor.
2. You use a *logic synthesizer* program to transform the HDL or schematic into a *netlist*. The netlist is just a description of the various logic gates in your design and how they are interconnected.
3. You use the implementation tools to map the logic gates and interconnections into the FPGA. The FPGA consists of many *configurable logic blocks* which can be further decomposed into *look-up tables* that perform logic operations. The CLBs and LUTs are interwoven with various *routing resources*. The mapping tool collects your netlist gates into groups that fit into the LUTs and then the place & route tool assigns the gate collections to specific CLBs while opening or closing the switches in the routing matrices to connect the gates together.
4. Once the implementation phase is complete, a program extracts the state of the switches in the routing matrices and generates a *bitstream* where the ones and zeroes correspond to open or closed switches. (This is a bit of a simplification, but it will serve for the purposes of this tutorial.)
5. The bitstream is *downloaded* into a physical FPGA chip (usually embedded in some larger system). The electronic switches in the FPGA open or close in response to the binary bits in the bitstream. Upon completion of the downloading, the FPGA will perform the operations specified by your HDL code or schematic.

That's really all there is to it. Xilinx WebPACK provides the HDL and schematic editors, logic synthesizer, fitter, and bitstream generator software. The XSTOOLS from XESS provide utilities for downloading the bitstream into an [XSA-100 Board](#) containing a Xilinx XC2S100 SpartanII FPGA.

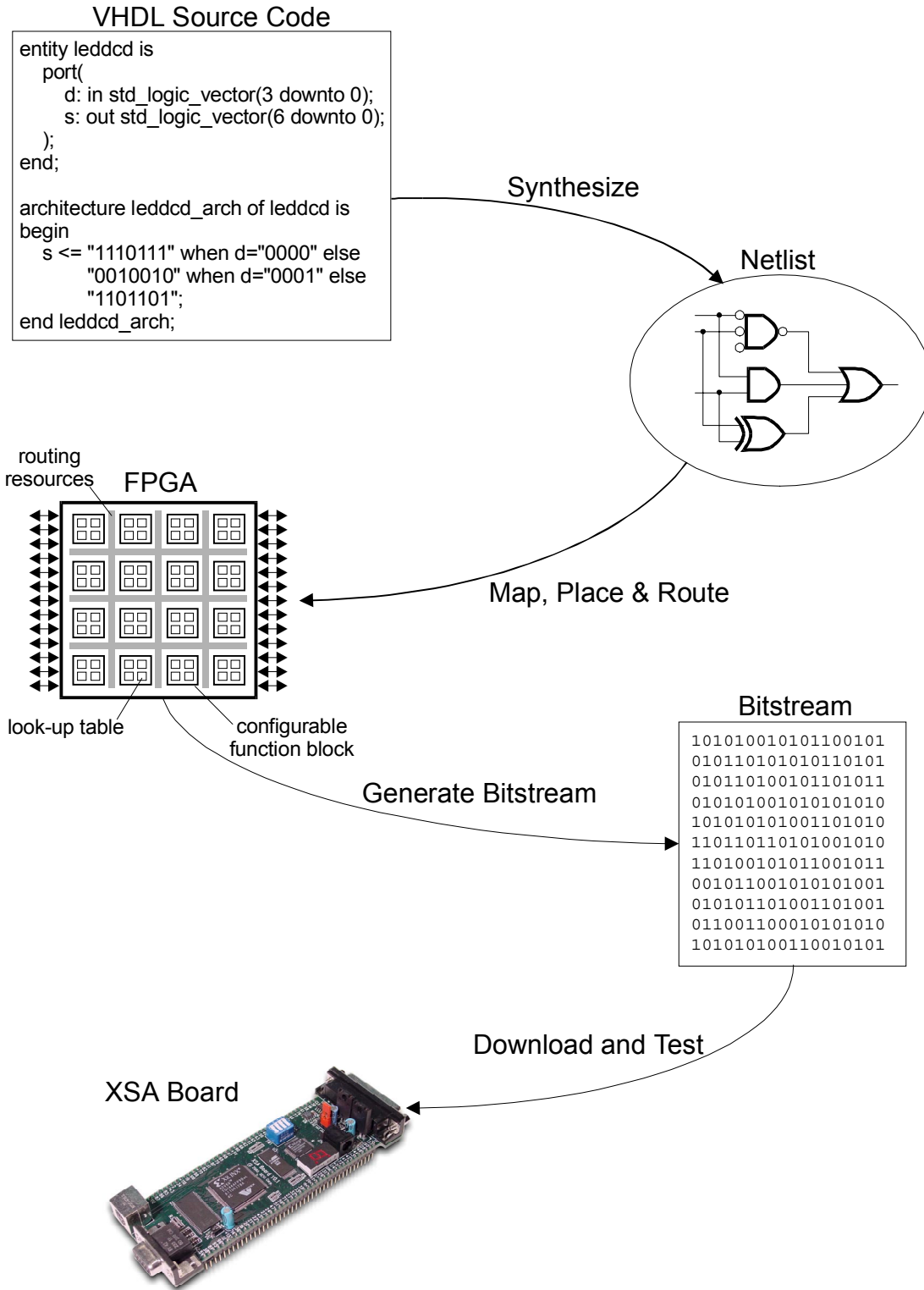



# 2

---

# Installing WebPACK

## Getting WebPACK

Before downloading the WebPACK software you will have to register at [http://www.Xilinx.com/xlnx/xil\\_entry2.jsp?sMode=login&group=webpack](http://www.Xilinx.com/xlnx/xil_entry2.jsp?sMode=login&group=webpack). You will choose a user ID and password and then you will be allowed to enter the site. Then you can go to <http://www.Xilinx.com/webpack/index.html> to begin downloading the WebPACK software. After entering the WebPACK homepage, click on the Design Configurations button as shown on the next page.

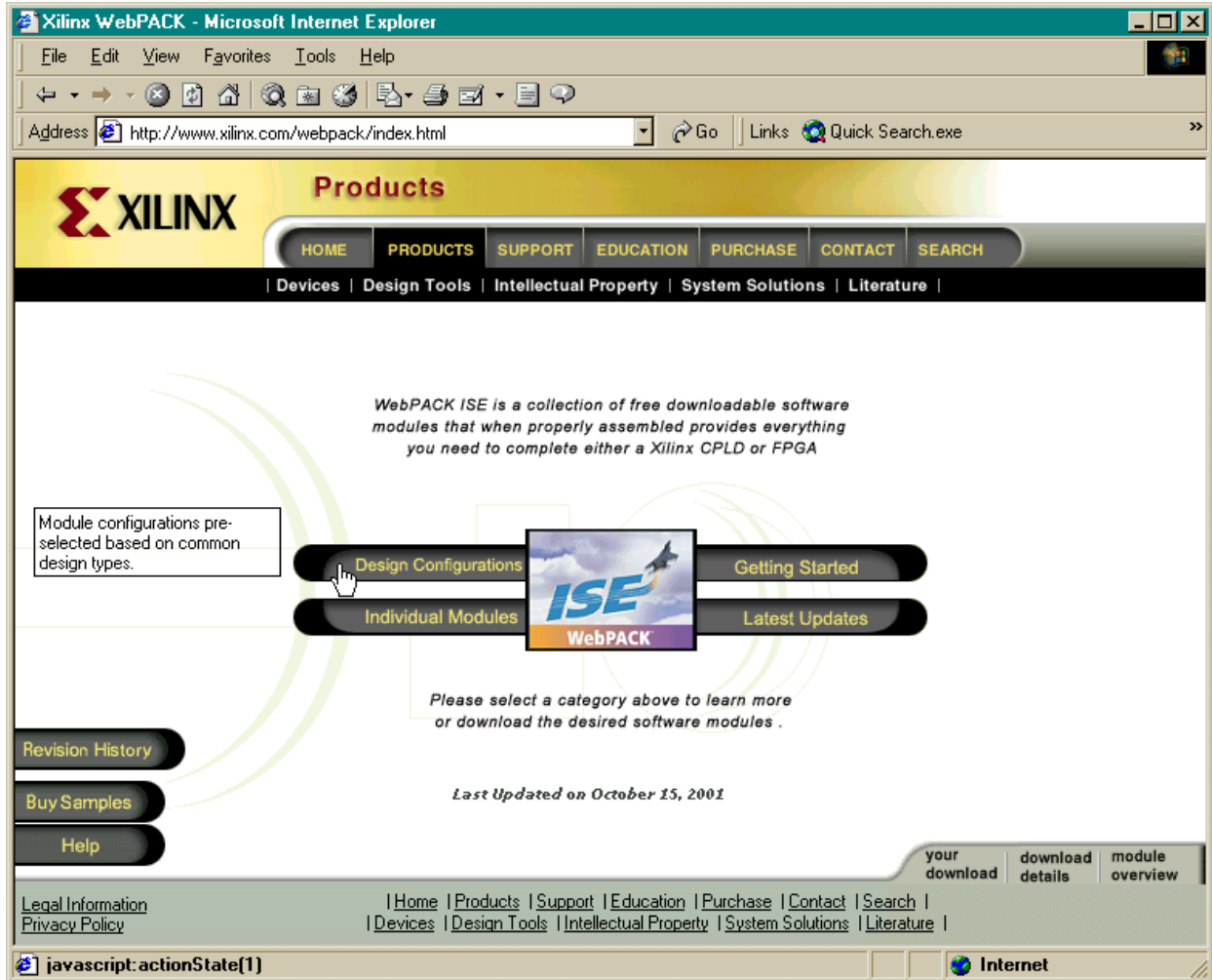

Next, click on the Select All button. This will select all the WebPACK software modules that cover both FPGA and CPLD designs.



Then click on the Download button to begin downloading the WebPACK software.



Click on the link to download the WebPACK software in the Download WebPACK window. You can use either the FTP or the HTTP link. (You can also download the demo version of the ModelSim HDL simulator but we will not discuss the operation of that software in this tutorial.)

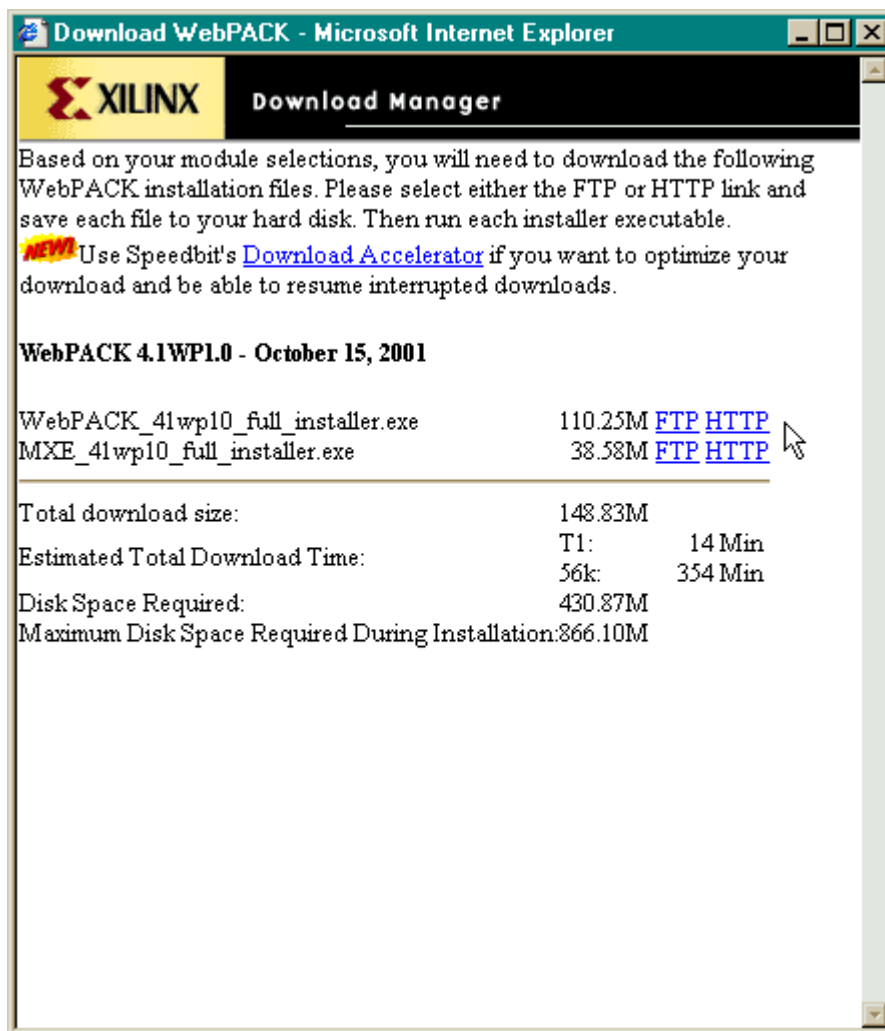

## Installing WebPACK

After the WebPACK software download completes, double-click the .EXE file. The installation script will run and install the software. Accept the default settings for everything and you shouldn't have any problems.

## Getting XSTOOLS

If you are going to download your FPGA bitstreams into an XSA Board, then you will need to get the XSTOOLS software from <http://www.xess.com/ho07000.html>. Just download the [xstools4.exe](#) file.

## **Installing XSTOOLS**

Double-click the xstools4.exe file. The installation script will run and install the software. Accept the default settings for everything.

# 3

## Our First Design

### An LED Decoder

The first FPGA design we will try is an LED decoder. An LED decoder takes a four-bit input and outputs seven signals which drive the segments of an LED digit. The LED segments will be driven to display the digit corresponding to the hexadecimal value of the four input bits as follows:

Four-bit Input	Hex Digit	LED Display
0000	0	0
0001	1	1
0010	2	2
0011	3	3
0100	4	4
0101	5	5
0110	6	6
0111	7	7
1000	8	8
1001	9	9
1010	A	A
1011	B	B
1100	C	C
1101	D	D
1110	E	E
1111	F	F

A high-level diagram of the LED decoder looks like this:

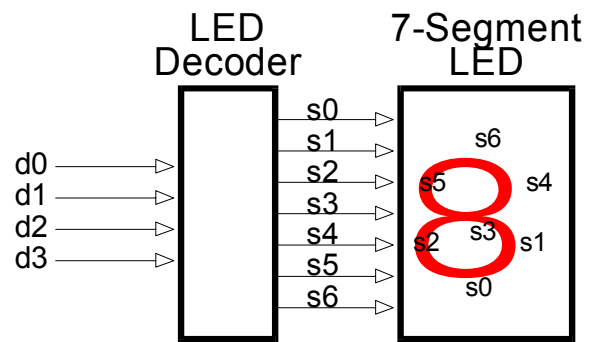



## Starting WebPACK Project Navigator



We start WebPACK by double-clicking the icon, on the desktop. This will bring up an empty project window as shown below. The window has four panes:

1. A **source pane** that shows the organization of the source files that make up our design. There are four tabs so we can view the source files, functional modules, or HDL libraries for our project or look at various snapshots of the project.
2. A **process pane** that lists the various operations we can perform on a given object in the source pane.
3. A **log pane** that displays the various messages from the currently running process.
4. An **editor pane** where we can enter HDL code. Schematics are entered in a separate window.

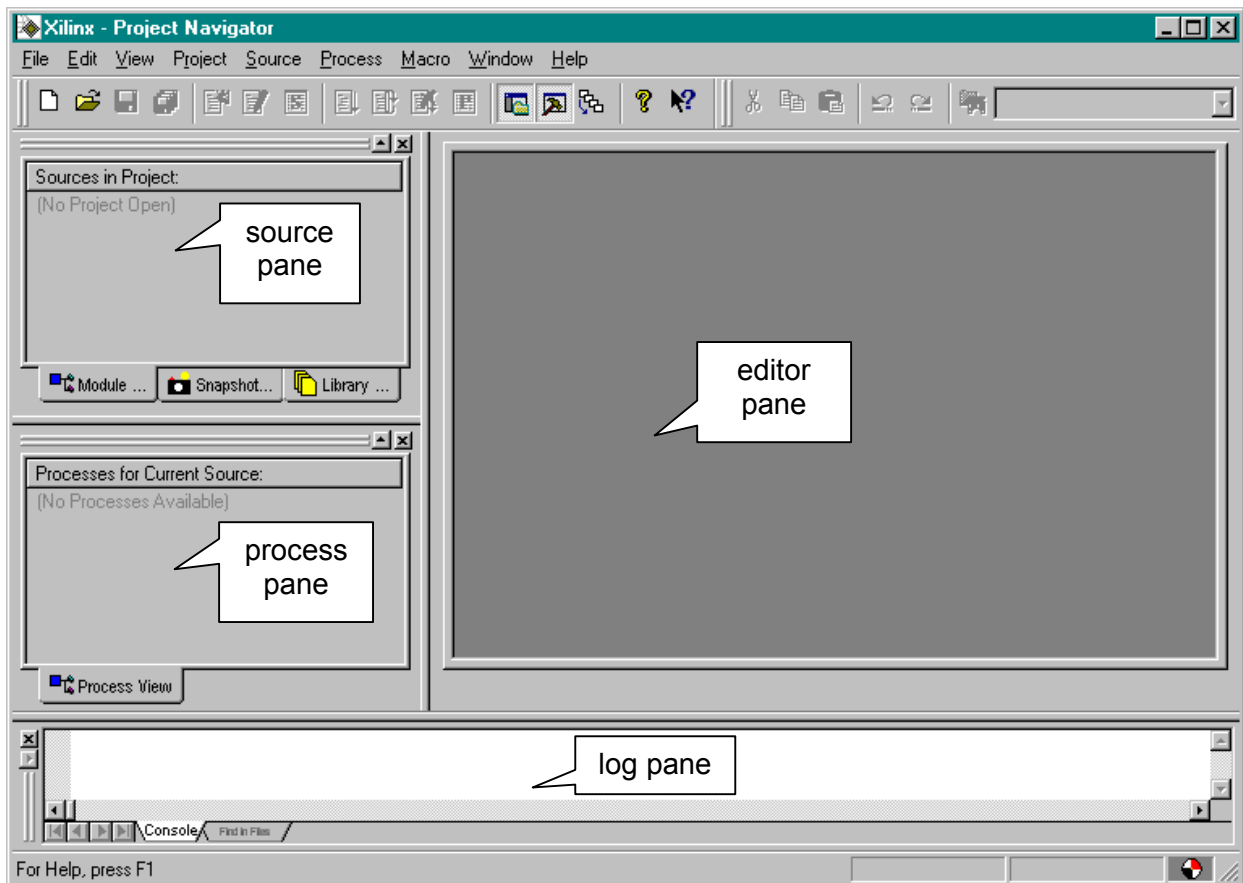

To start our design, we must create a new project by selecting the File→New Project item from the menu bar.

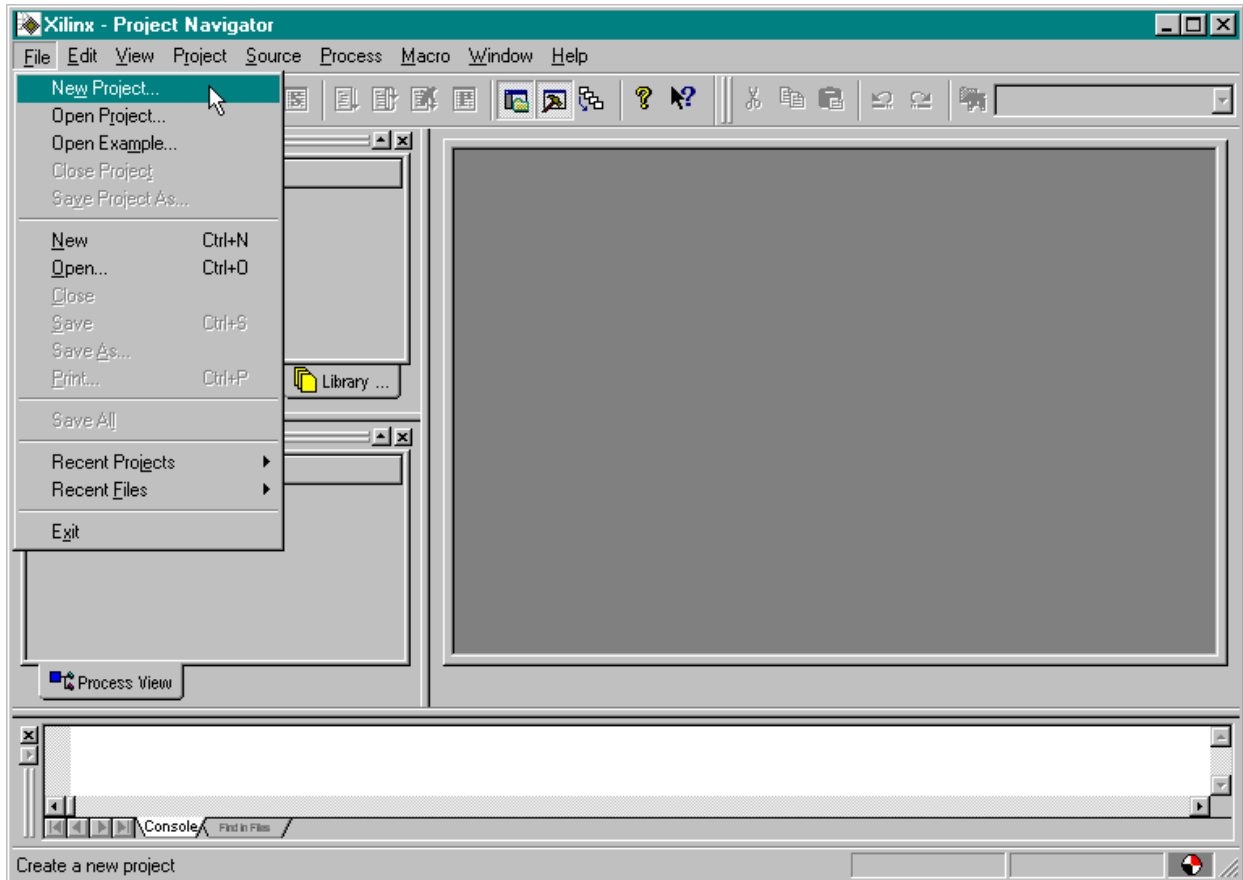

This brings up the **New Project** window where we can enter the location of our project files, project name, the target device for this design, and the tools used to synthesize logic from our source files.

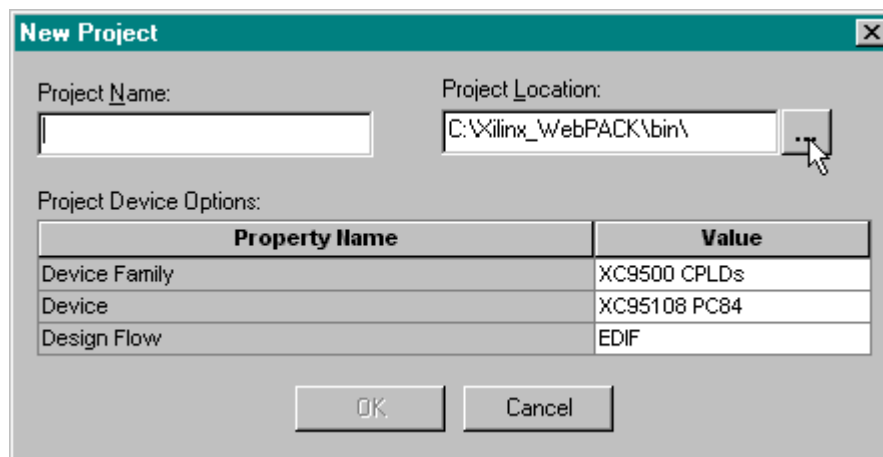

Click on the ... button next to the Project Location field and use the **Browse for Folder** window to select a folder where our project files will be stored. For our design examples, we will store everything in the C:\tmp\fpga\_designs folder.

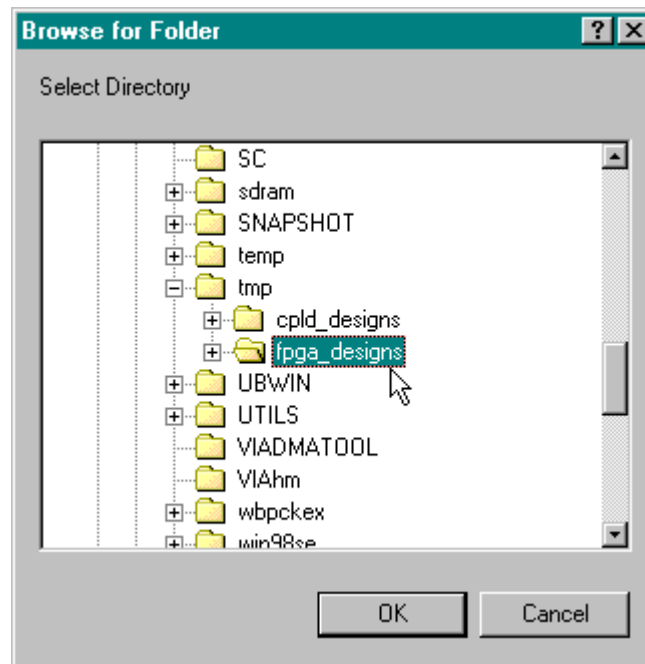

Next we will give our LED decoder design the descriptive title of `design1` by typing it into the Project name field.

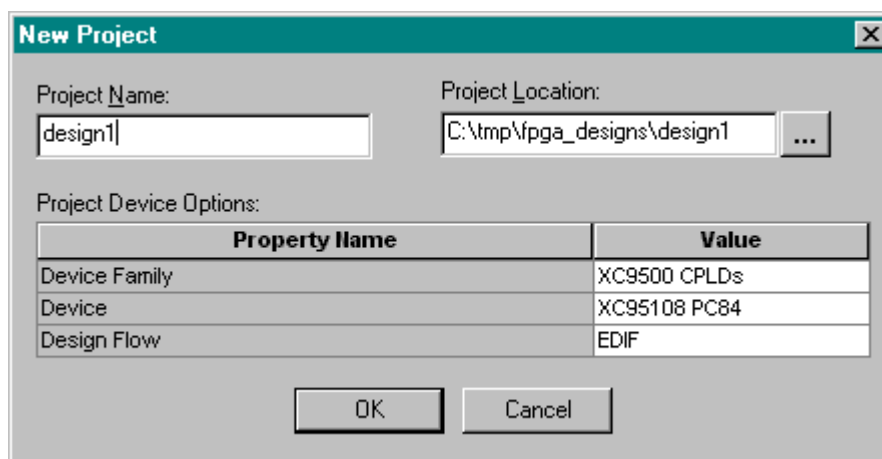

To set the family of FPGA devices we will target with this design, click in the Value field of the Device Family property. Select the Spartan2 entry in the pop-up menu that appears.

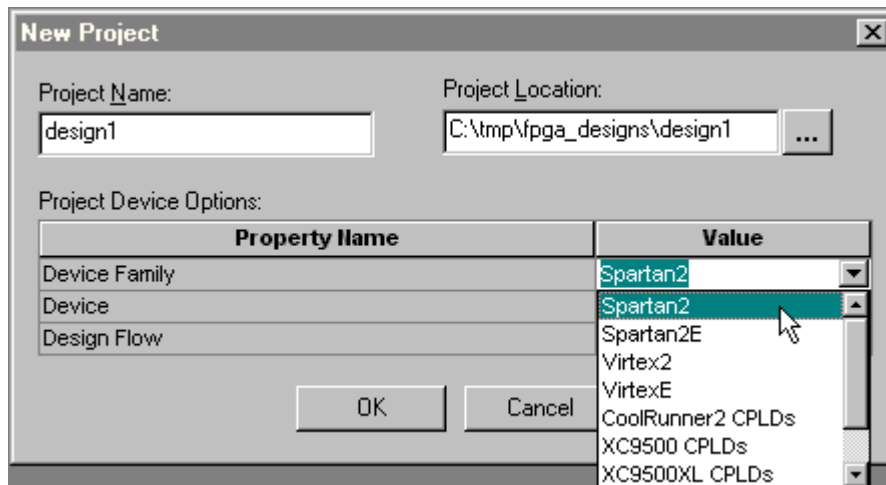

Then click in the Value field of the Device property to select a particular device within the device family. For our designs, we will select the xc2s100-5tq144 since this is the device used in the XSA-100 Board where we will test our design.

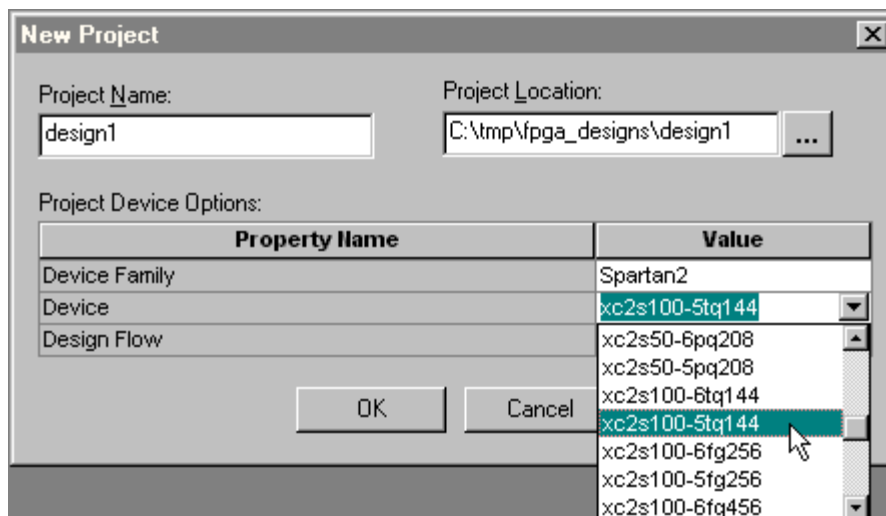

Finally, our design will be done using VHDL so click in the Value field of the Design Flow property and select XST VHDL from the pop-up menu. This enables the Xilinx VHDL synthesizer.

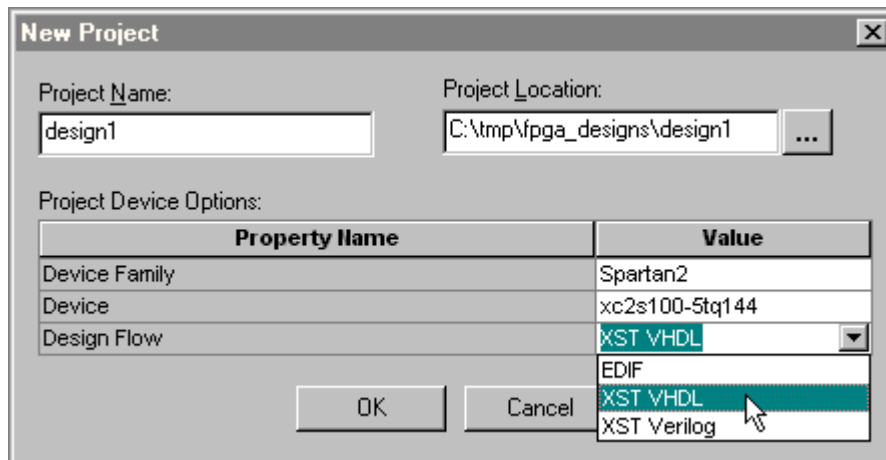

Once all the fields are set, click on OK in the **New Project** window. Now the Sources pane in the **Project Navigator** window contains two items:

1. A project object called design1.
2. A chip object called xc2s100-5tq144 - XST VHDL.

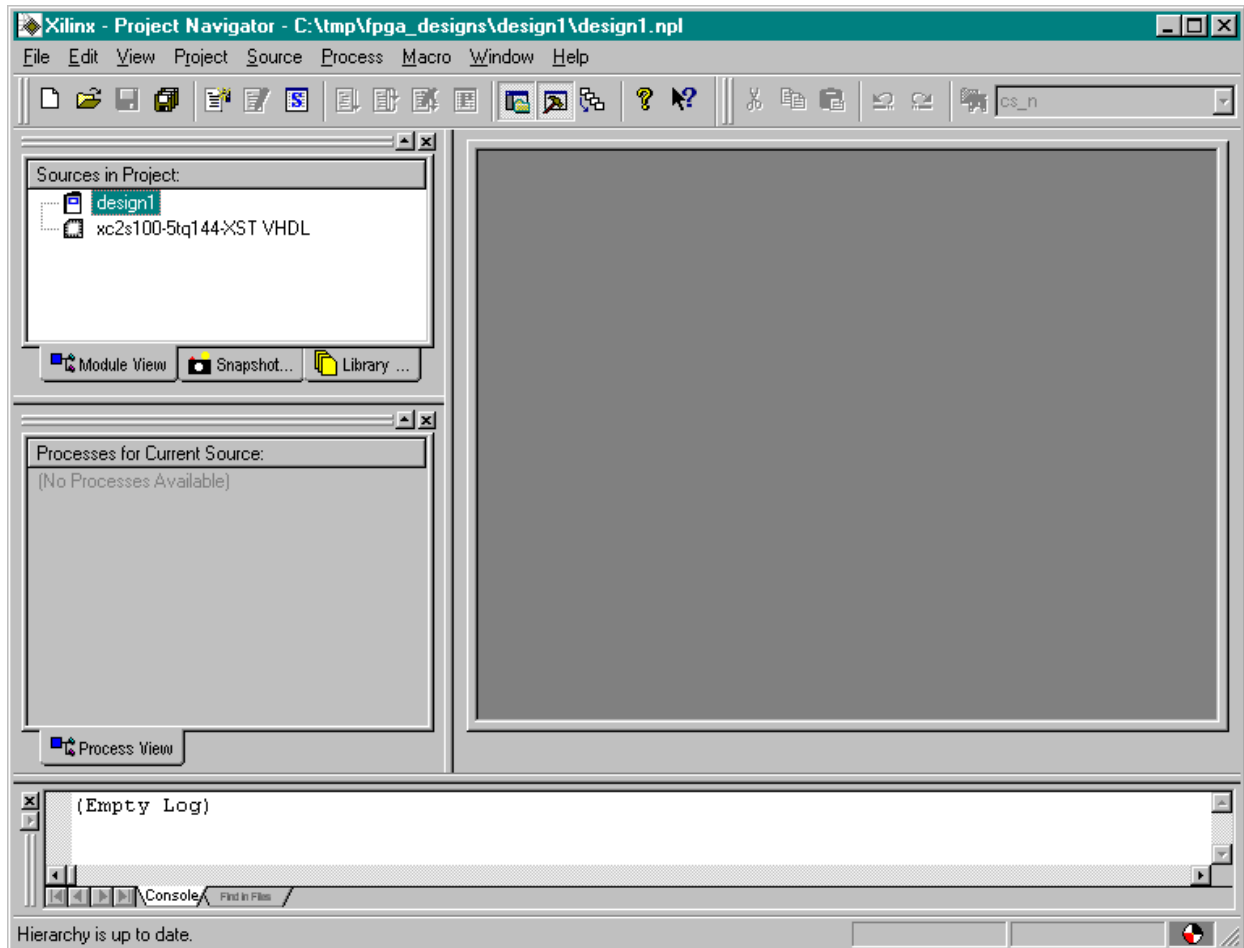

## Describing Your Design With VHDL

Once all the project set-up is complete, we can begin to actually design our LED decoder circuit. We start by adding a VHDL file to the *design1* project. Right-click on the xc2s100-5tq144 object in the Sources pane and select New Source ... from the pop-up menu as shown below.

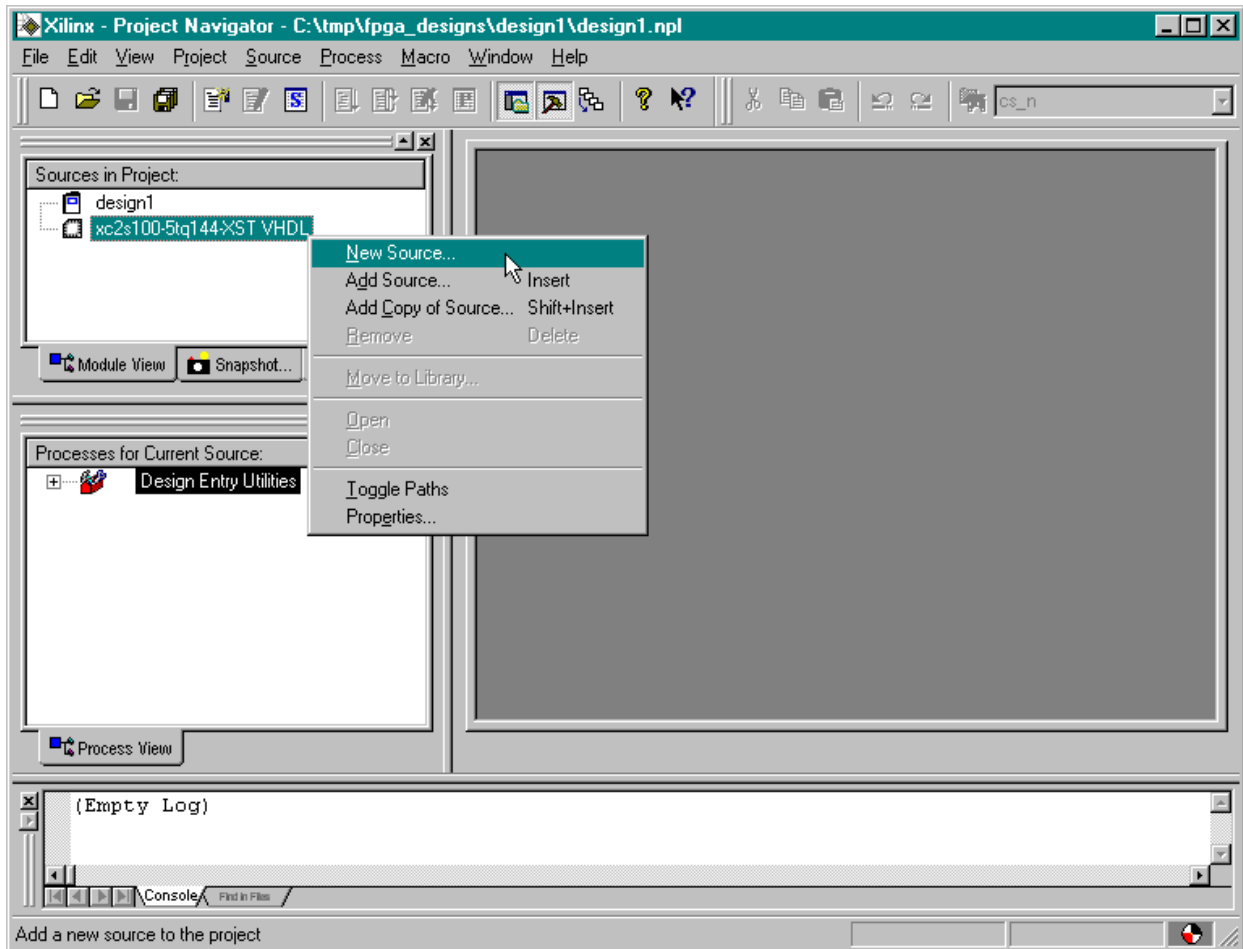

This causes a window to appear where we must select the type of source file we want to add. Since we are describing the LED decoder with VHDL, just highlight the VHDL Module item. Then we type the name of the module, `leddcd`, into the File Name field and click on Next.

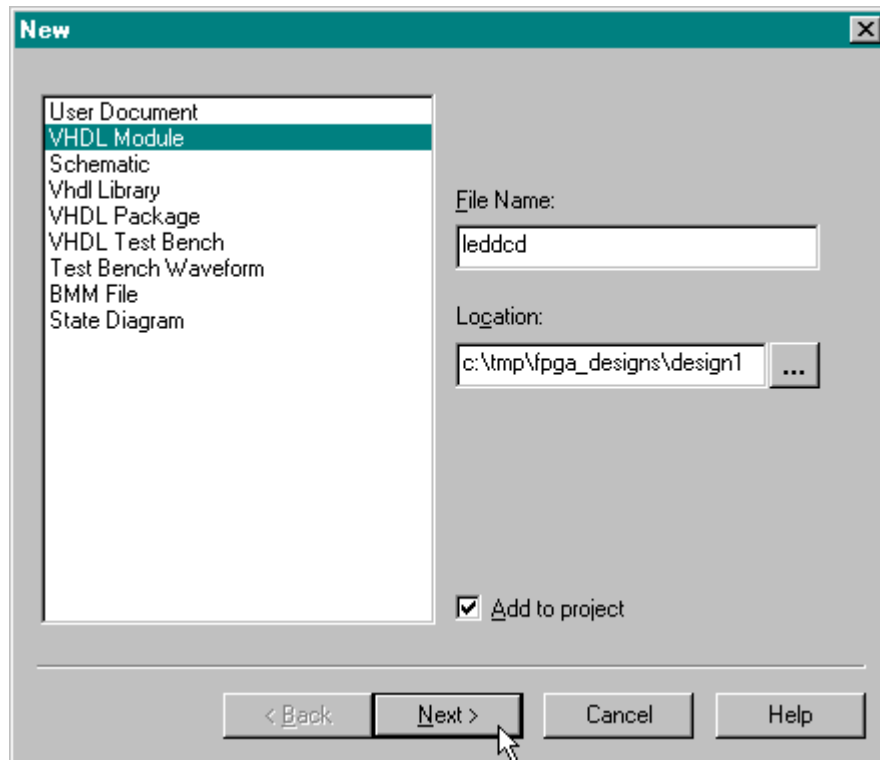



Then the **Define VHDL Source** window appears where we declare the inputs and outputs to the LED decoder circuit. In the first row, click in the Port Name field and type in `d` (the name of the inputs to the LED decoder). The `d` input bus has a width of four, so click in the MSB field and increment the upper range of the input field to 3 while leaving 0 in the LSB field.

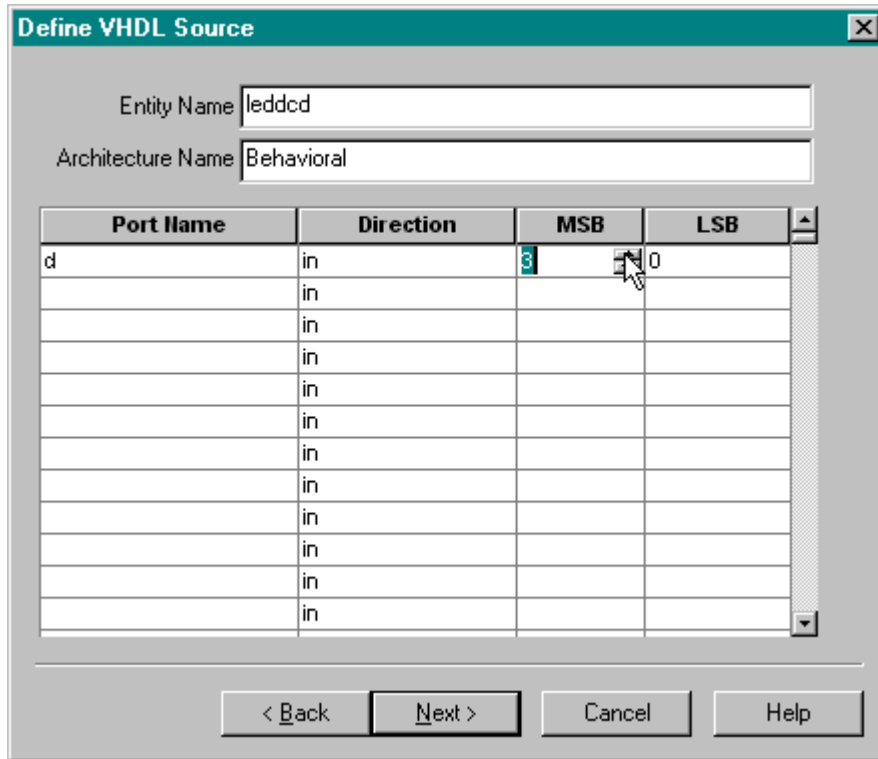

Perform the same operations to create the seven-bit wide **s** bus that drives the LEDs.

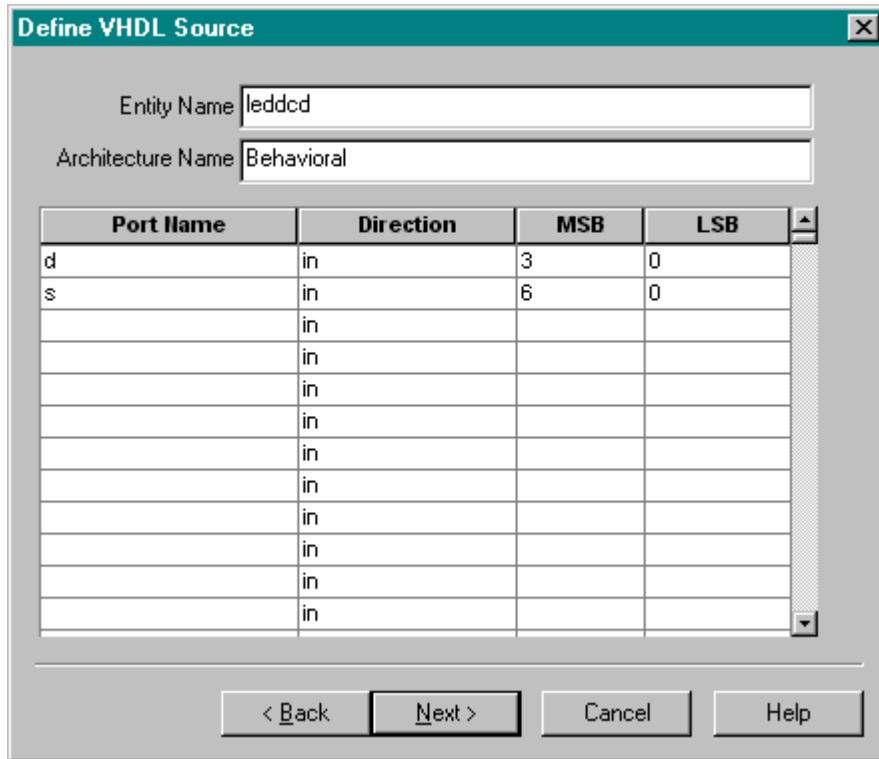

We must also click in the Direction field for the **s** bus and select out from the pop-up menu in order to make the **s** bus signals into outputs.

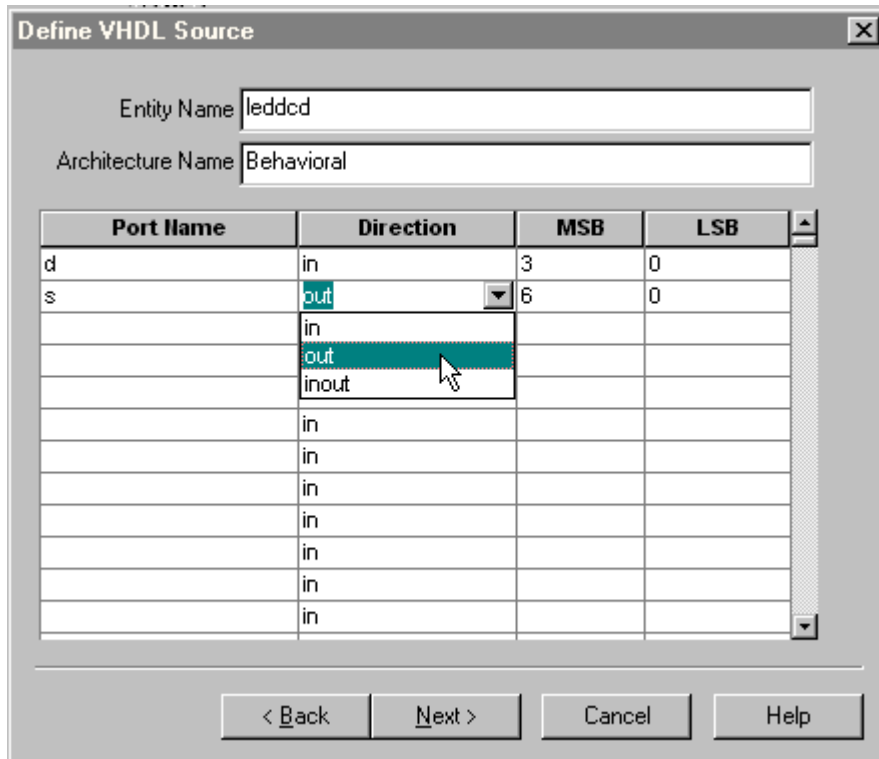

Click on Next in the **Define VHDL Source** window and we will get a summary of the information we just typed in:

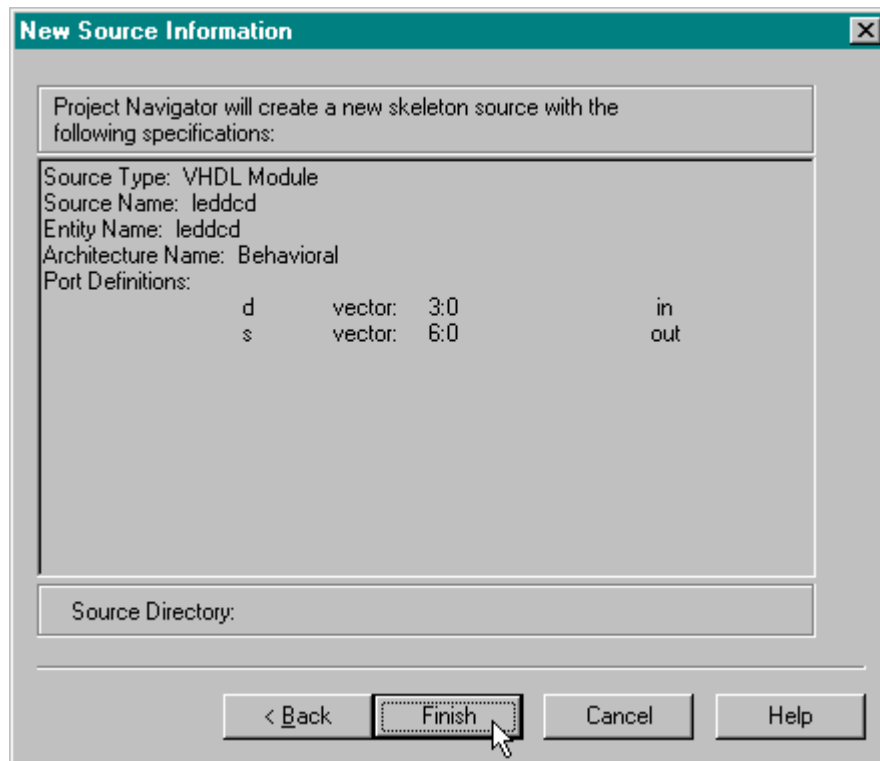

After clicking on Finish, the editor pane of the **Project Navigator** window displays a VHDL skeleton for our LED decoder. (We also see the leddcd.vhd file has been added to the Sources pane.) Lines 1-4 create links to the IEEE library and packages that contain various useful definitions for describing a design. The LED decoder inputs and outputs are declared in the VHDL entity on lines 6-9. We will describe the logic operations of the decoder in the architecture section between lines 13 and 16.

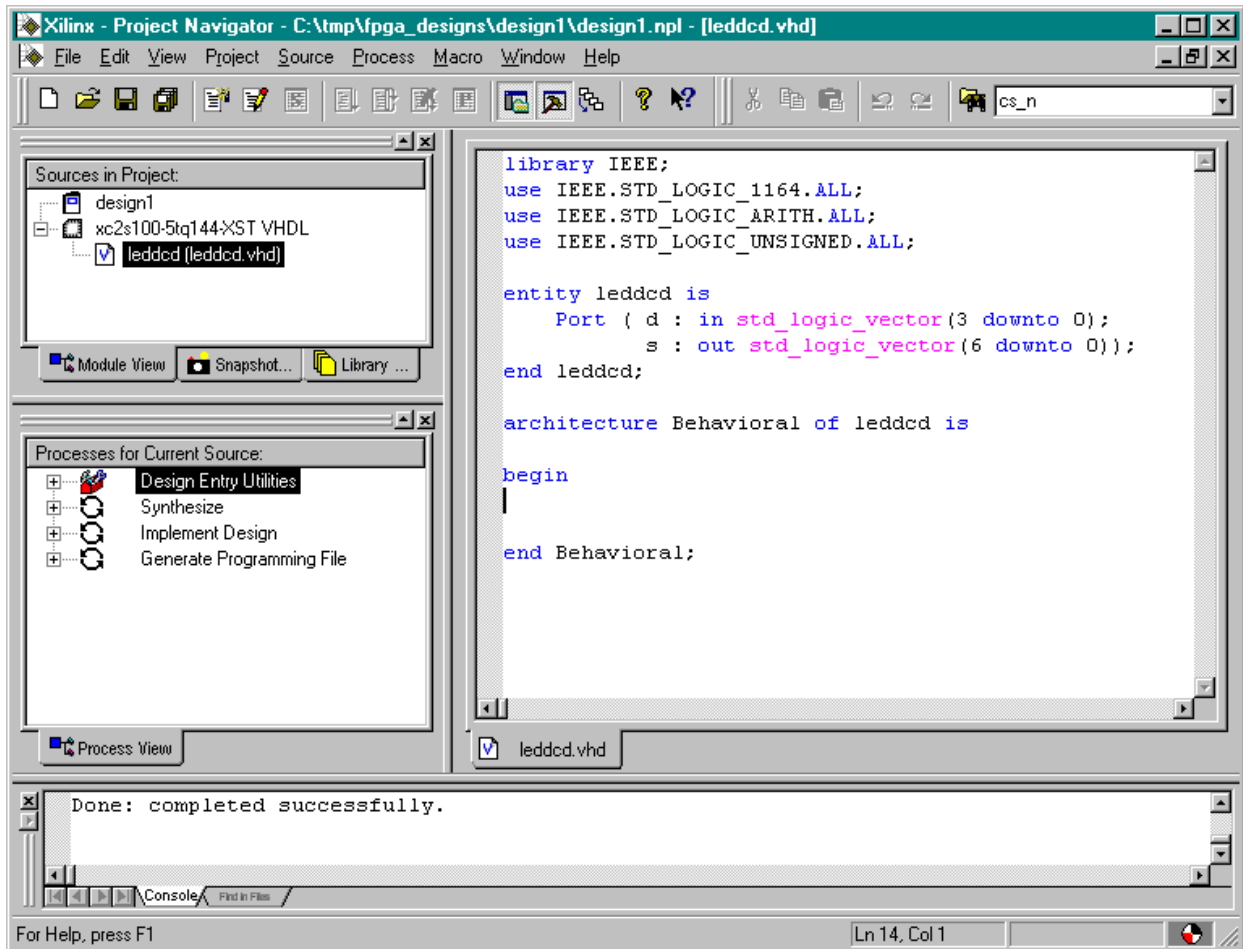

The completed VHDL file for the LED decoder is shown below. The architecture section contains a single statement which assigns a particular seven-bit pattern to the **s** output bus for any given four-bit input on the **d** bus (lines 15-30).

```
library IEEE;
use IEEE.STD_LOGIC_1164.ALL;
use IEEE.STD_LOGIC_ARITH.ALL;
use IEEE.STD_LOGIC_UNSIGNED.ALL;

entity leddcd is
    Port ( d : in std_logic_vector(3 downto 0);
          s : out std_logic_vector(6 downto 0));
end leddcd;

architecture Behavioral of leddcd is

begin

    s <=    "1110111" when d="0000" else
           "0010010" when d="0001" else
           "1011101" when d="0010" else
           "1011011" when d="0011" else
           "0111010" when d="0100" else
           "1101011" when d="0101" else
           "1101111" when d="0110" els
           "1010010" when d="0111" else
           "1111111" when d="1000" else
           "1111011" when d="1001" else
           "1111110" when d="1010" else
           "0101111" when d="1011" else
           "0001101" when d="1100" else
           "0011111" when d="1101" else
           "1101101" when d="1110" else
           "1101100"

end Behavioral;
```

Once the VHDL source is entered, we click on the  button to save it in the leddcd.vhd file.

## Checking the VHDL Syntax

We can check for errors in our VHDL by highlighting the leddcd object in the Sources pane and then double-clicking on Check Syntax in the Process pane as shown below.

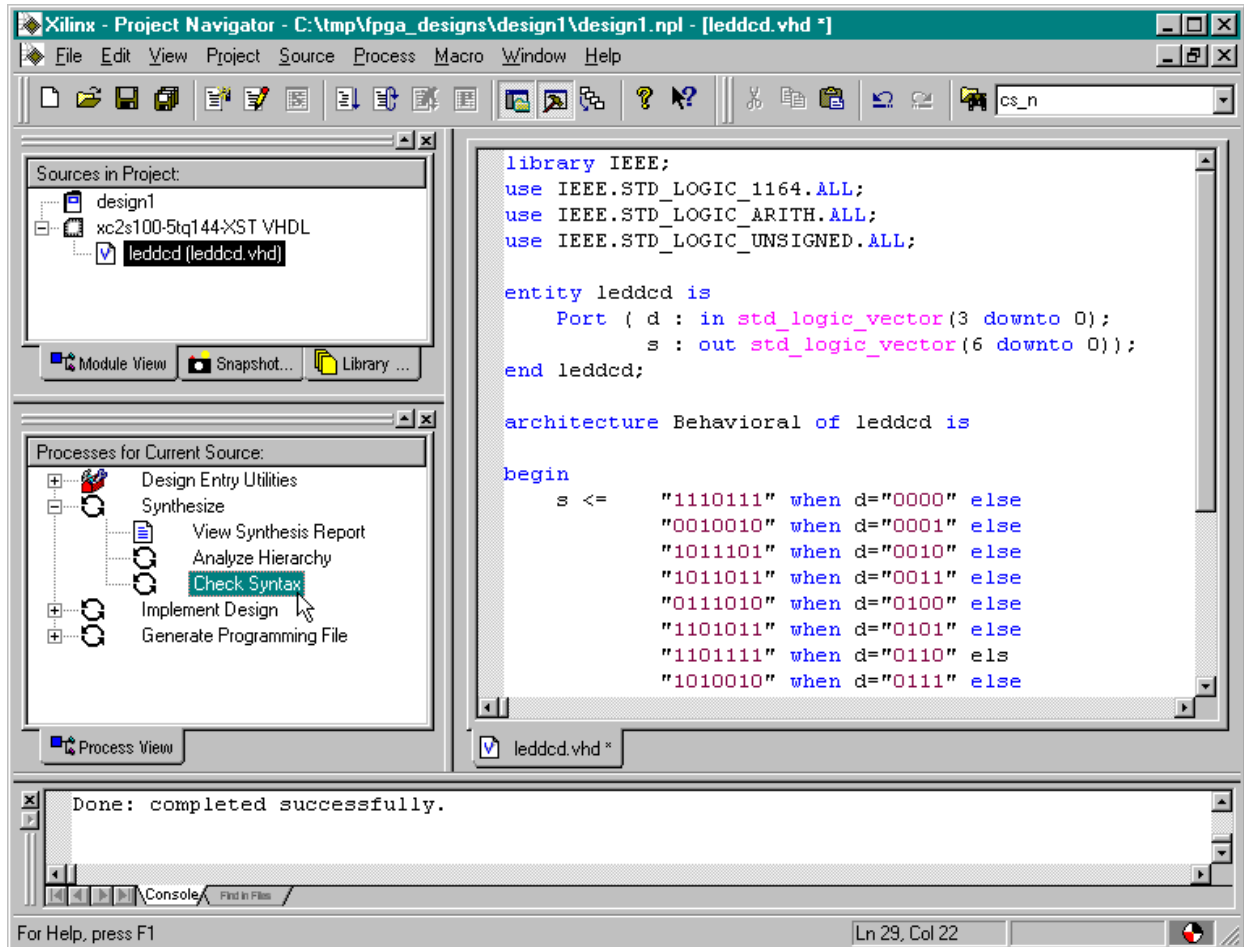

The syntax checking tool grinds away and then displays the result in the process window. In our case, an error was found as indicated by the **✖** next to the Check Syntax process. But what is the error and where is it?

## Fixing VHDL Errors

We can find the location of the error by scrolling the log pane at the bottom of the **Project Navigator** window until we find an error message. In this case, the error is located on line 20. You can manually scroll to line 20 in the editor pane, or you can double-click on the error message in the log pane to go directly to the erroneous line.

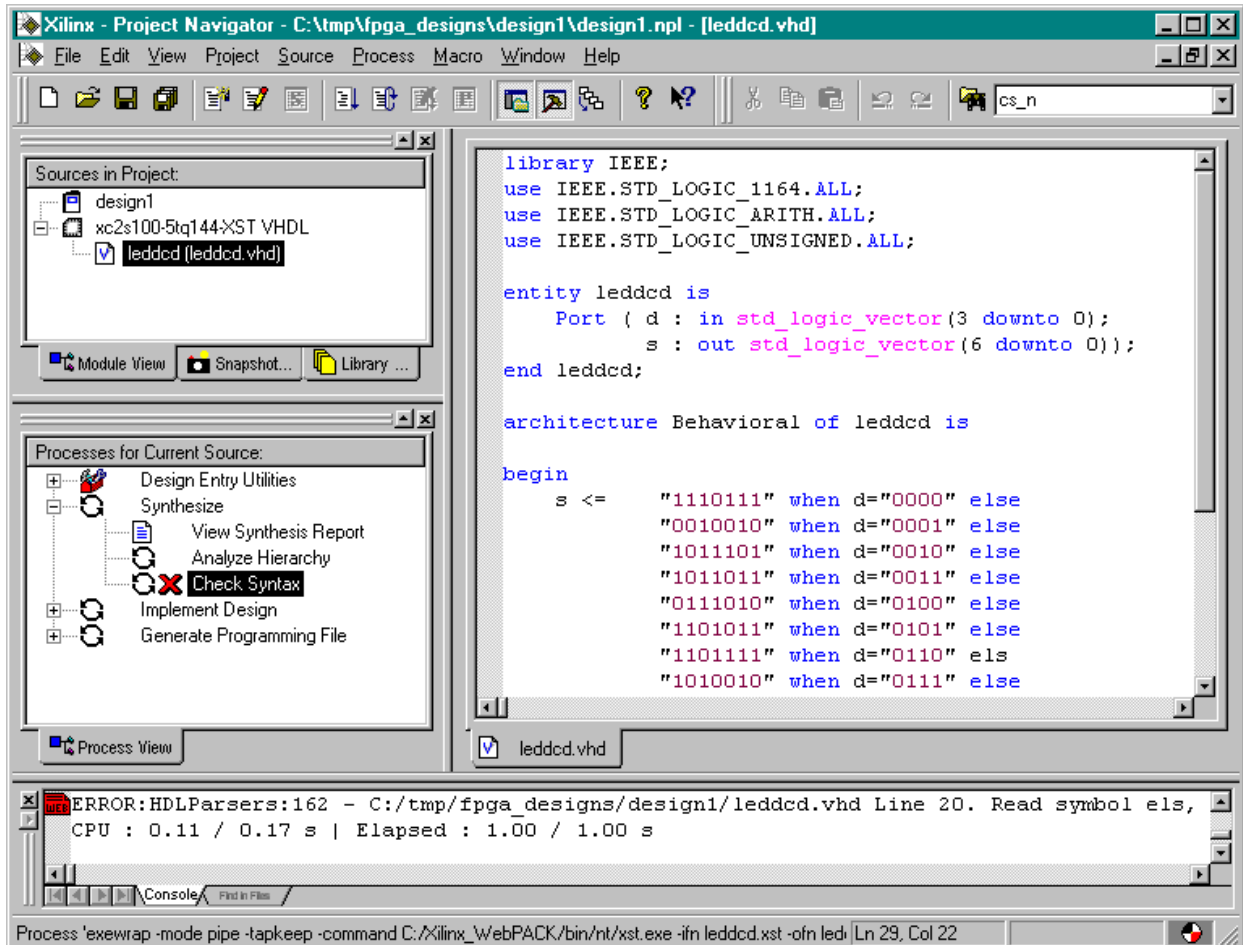

On line 20, we see that we have left the 'e' off the end of the `else` keyword. After correcting this error, we can double-click on Check Syntax in the Process pane to re-check the VHDL code. We will be asked to save the file before the syntax check proceeds. Click on Yes.

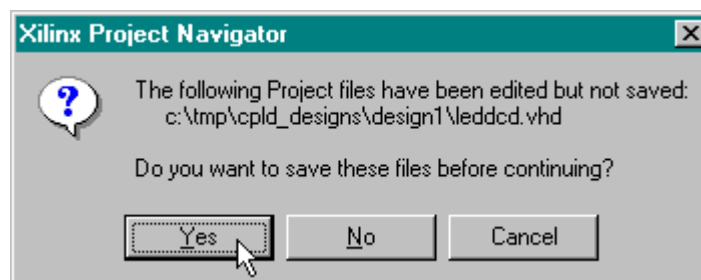

The syntax checker now finds another error on line 31 of the VHDL code.

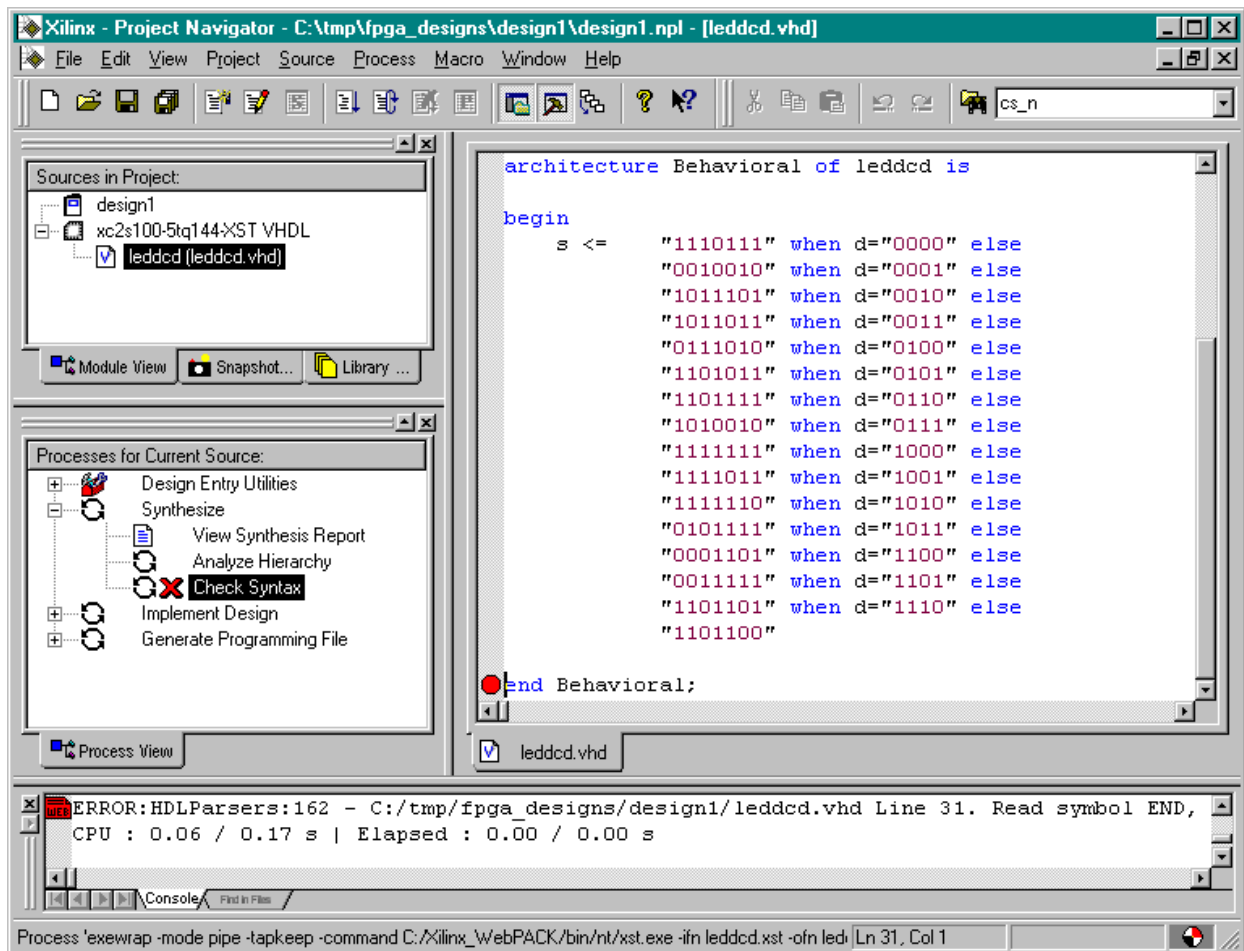



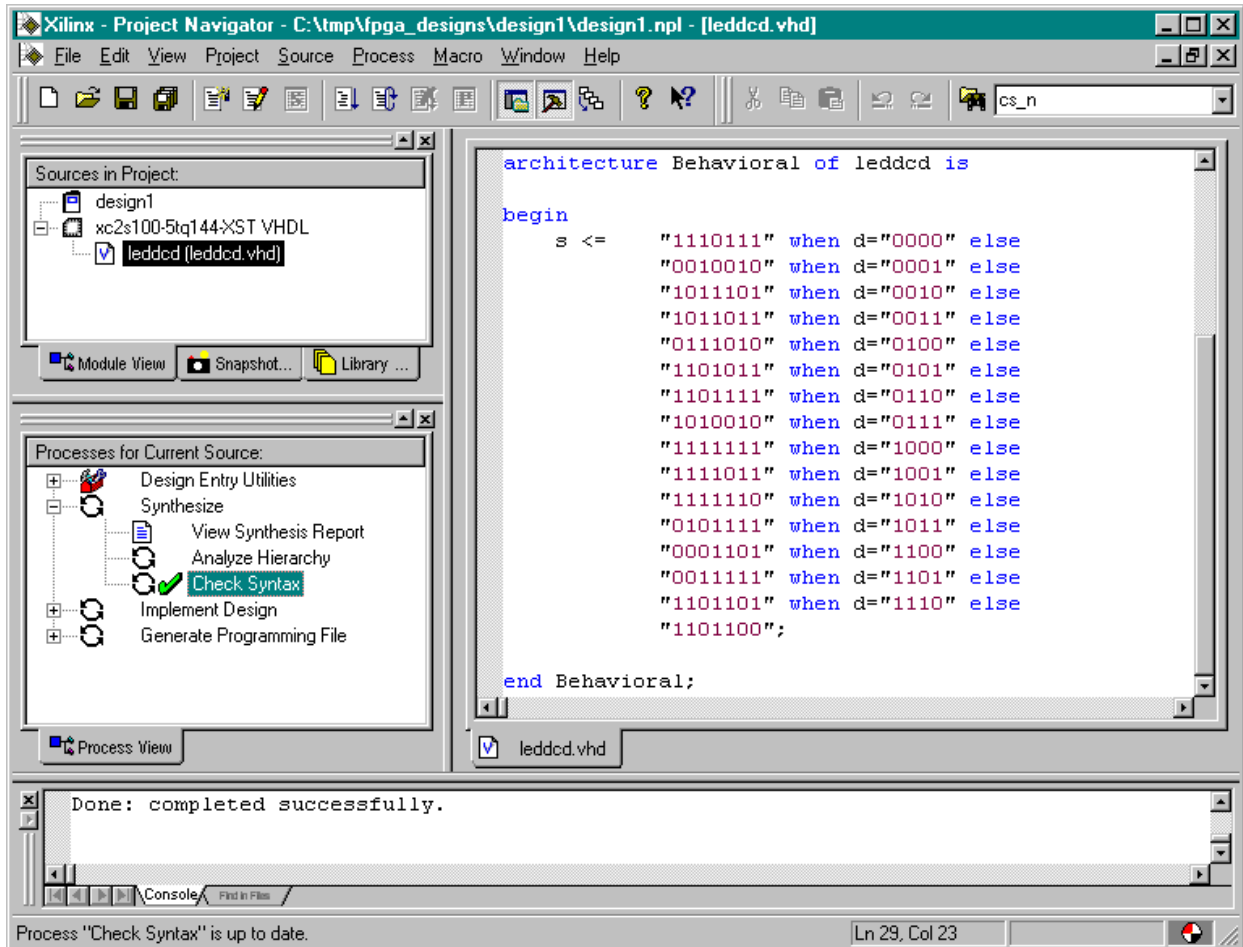

When we look at line 31 we see it is just the end statement for the architecture section. The VHDL syntax checker was expecting to find a ';' and we can see it is missing from the end of line 29. Adding the semicolon to the end of line 29 and save the file. Now when we double-click the Check Syntax process, it runs and then displays a  to indicate there are no more errors.

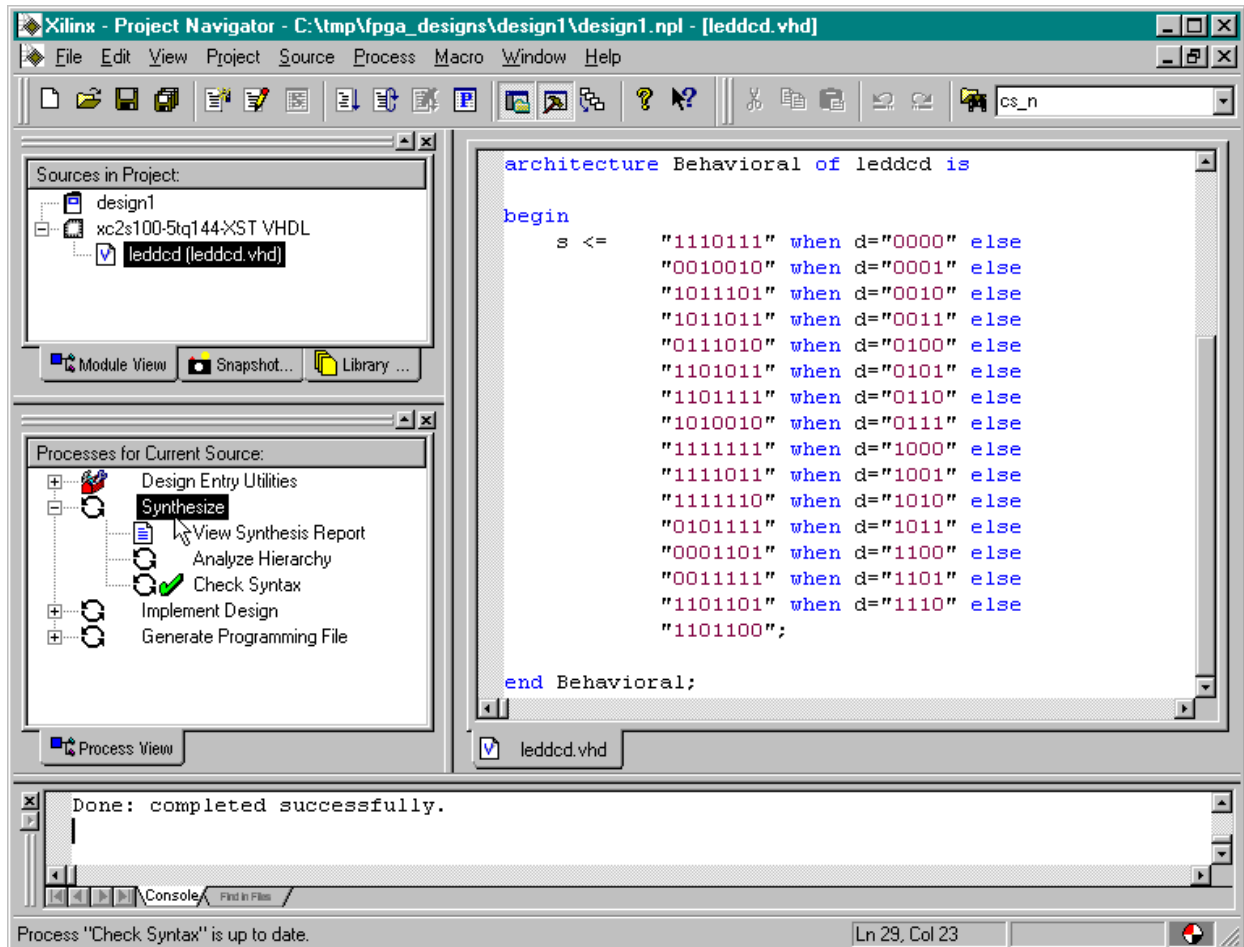

## Synthesizing the Logic circuitry for Your Design

Now that we have valid VHDL for our design, we need to convert it into a logic circuit. This is done by highlighting the leddcd object in the Sources pane and then double-clicking on the Synthesize process as shown below.





The synthesizer will read the VHDL code and transform it into a netlist of gates. This will take only a minute. If no problems are detected, a  will appear next to the Synthesize process. You can double-click on the View Synthesis Report to see the various synthesizer options that were enabled and some simple statistics for the synthesized design.

## Implementing the Logic Circuitry in the FPGA

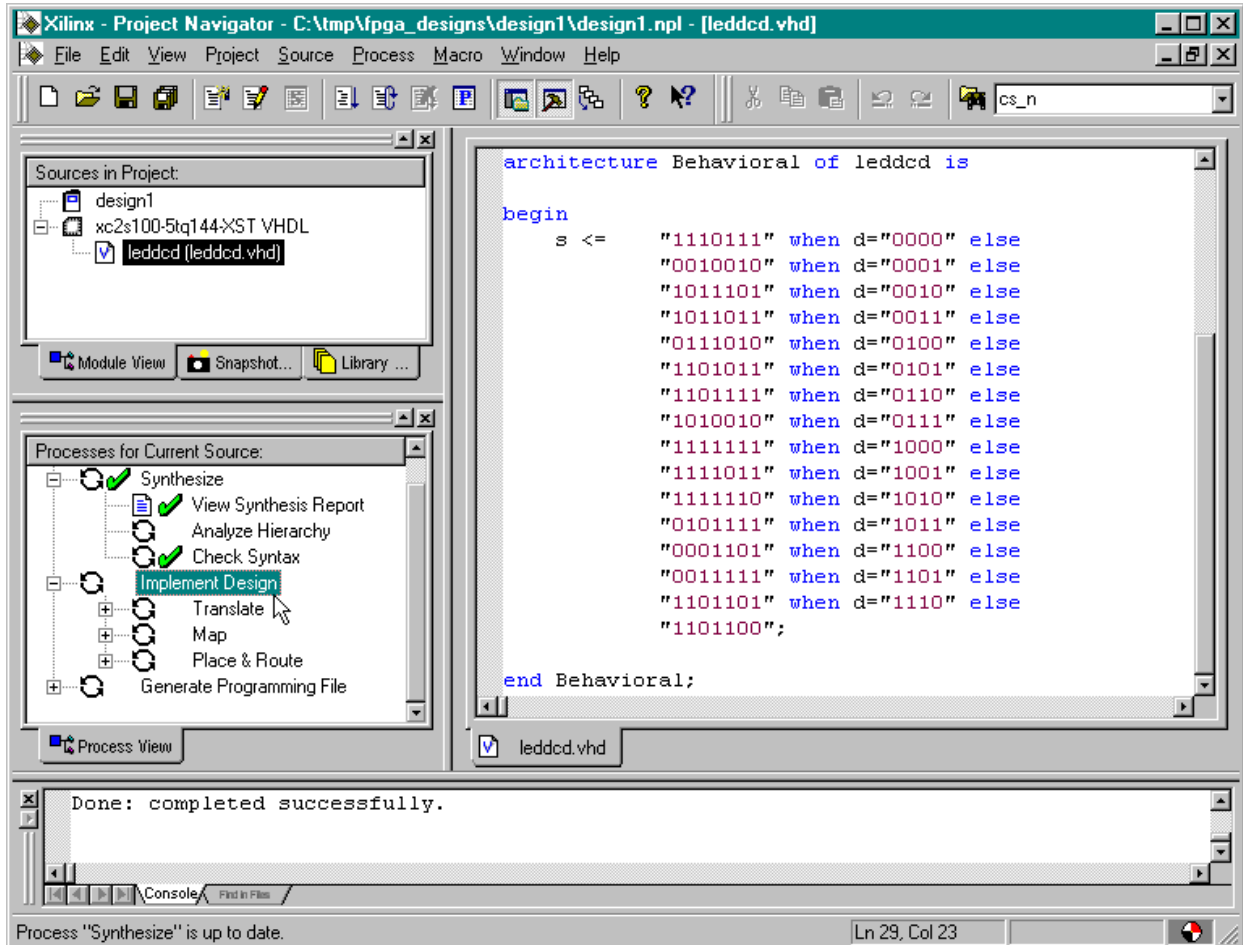
We now have a synthesized logic circuit for the LED decoder, but we need to map, place & route it into the logic resources of the FPGA in order to actually use it. We start this process by highlighting the xc2s100-5tq144 object in the Sources pane and then double-clicking on the Implement Design process.



You can watch the progress of the implementation process in the status bar at the bottom of the **Project Navigator** window. For a simple design like the LED decoder, the fitting is completed in seconds (on a 850 MHz Athlon PC with 768 MBytes). A successful implementation is indicated by the  next to the Implement Design process. You can expand the Implement Design process to see the subprocesses within it. The Translate process converts the netlist output by the synthesizer into a Xilinx-specific format and annotates it with any design constraints we may specify (more on that later). The Map process decomposes the netlist and rearranges it so it fits nicely into the circuitry elements contained in the device we selected. Then the Place & Route process assigns the mapped elements to specific locations in the FPGA and sets the switches to route the logic signals between them. If the Implement Design process had failed, a  would appear next to the subprocess where the error occurred. You may also see a  to indicate a successful completion but some warnings were issued or not all the subprocesses were enabled.

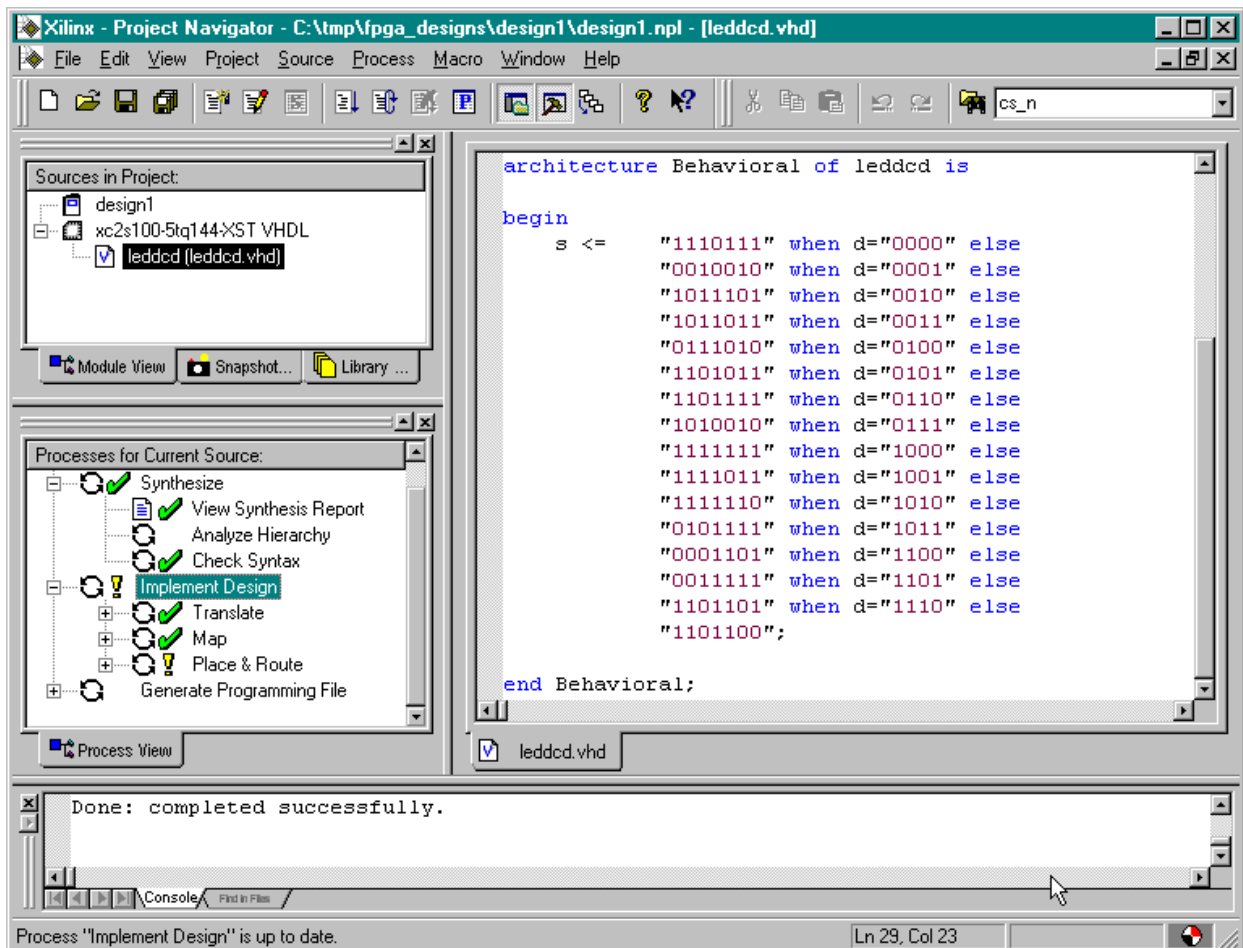

## Checking the Implementation

We have our design fitted into the XC2S100 FPGA, but how much of the chip does it use? Which pins are the inputs and outputs assigned to? We can find answers to these questions by double-clicking on the Place & Route Report and the Pad Report in the Process pane.

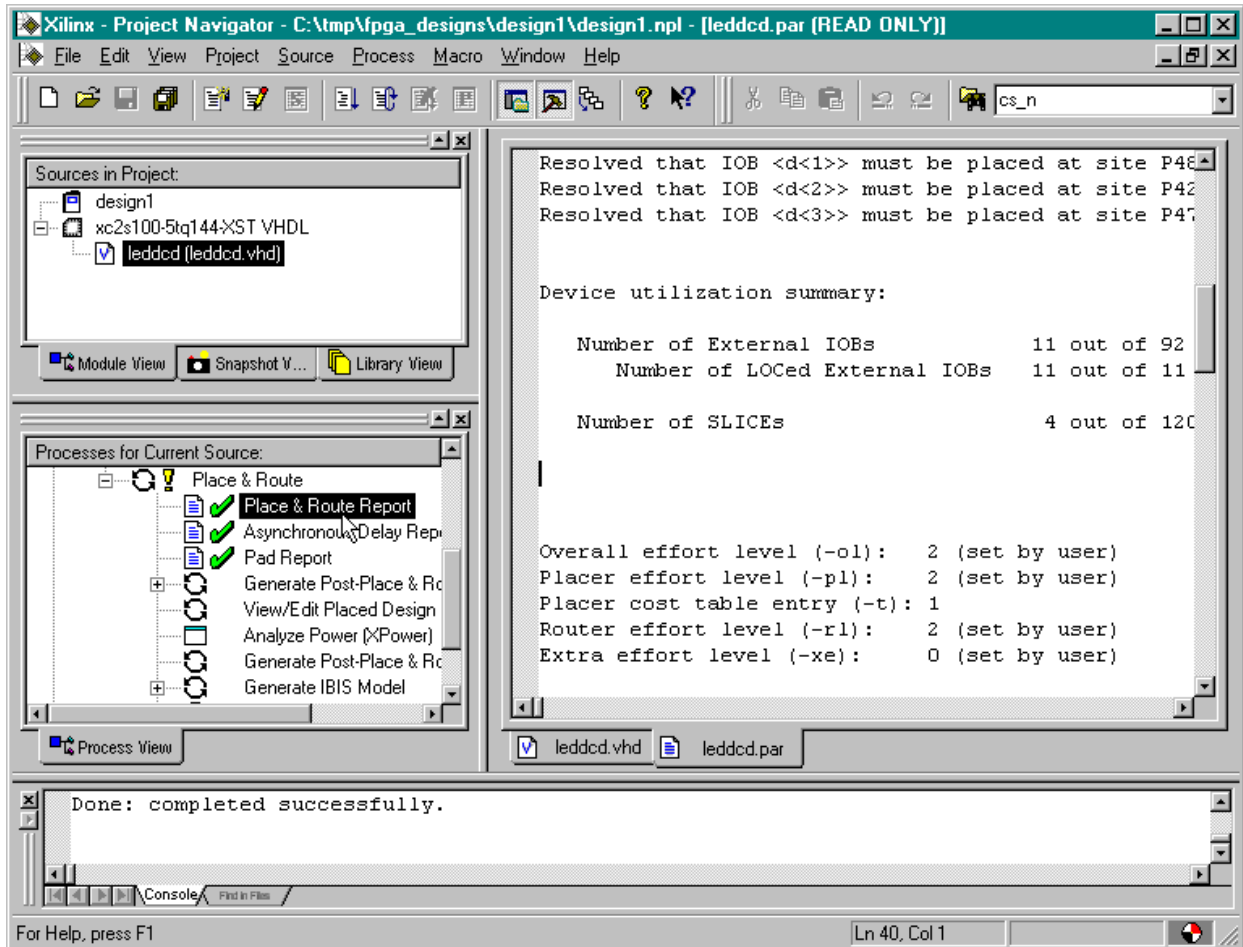

The device utilization of the LED decoder circuit can be found near the top of the place & route report. The circuit only uses 4 of the 1200 available slices in the XC2S100 FPGA. Each slice contains two CLBs and each CLB can compute the logic function for one LED segment output.

Device utilization summary:

Number of External IOBs	11 out of 92	11%
Number of LOCed External IOBs	0 out of 11	0%
Number of SLICES	4 out of 1200	1%

The pad report shows what pins the inputs and outputs use. The **d** inputs have been assigned to pins 121, 122, 123 and 112. The **s** outputs which drive the LED segments have been routed through pins 113, 114, 115, 116, 117, 118 and 120.

Pinout by Signal Name:

Signal Name	Pin Name	Pin Number	Direction	IO Standard	IO Ban
d<0>	VREF	P121	INPUT	LVTTL	6
d<1>		P122	INPUT	LVTTL	6
d<2>		P123	INPUT	LVTTL	6
d<3>		P112	INPUT	LVTTL	6
s<0>	VREF	P113	OUTPUT	LVTTL	6
s<1>		P114	OUTPUT	LVTTL	6
s<2>		P115	OUTPUT	LVTTL	6
s<3>	VREF	P116	OUTPUT	LVTTL	6
s<4>		P117	OUTPUT	LVTTL	6
s<5>		P118	OUTPUT	LVTTL	6
s<6>		P120	OUTPUT	LVTTL	6

## Constraining the Fit

The problem we have now is that the inputs and outputs for the LED decoder were assigned to pins picked by the implementation process, but these are not the pins we actually want to use on the XSA Board. The FPGA on the XSA Board has eight inputs which are driven by the PC parallel port and we would like to assign the LED decoder inputs to four of these as follows:

LED Decoder Input	XSA-100 XC2S100 FPGA Pin
d0	P50
d1	P48
d2	P42
d3	P47

Likewise, the XSA Board has a seven-segment LED attached to the following pins of the FPGA:

LED Decoder Output	XSA-100 XC2S100 FPGA Pin
s0	P67
s1	P39
s2	P62
s3	P60
s4	P46
s5	P57
s6	P49

How do we constrain the fitting process so it assigns the inputs and outputs to the pins we want to use? We start by highlighting the leddcd object in the Sources pane and then double-clicking the Edit Implementation Constraints (Constraints Editor) process.

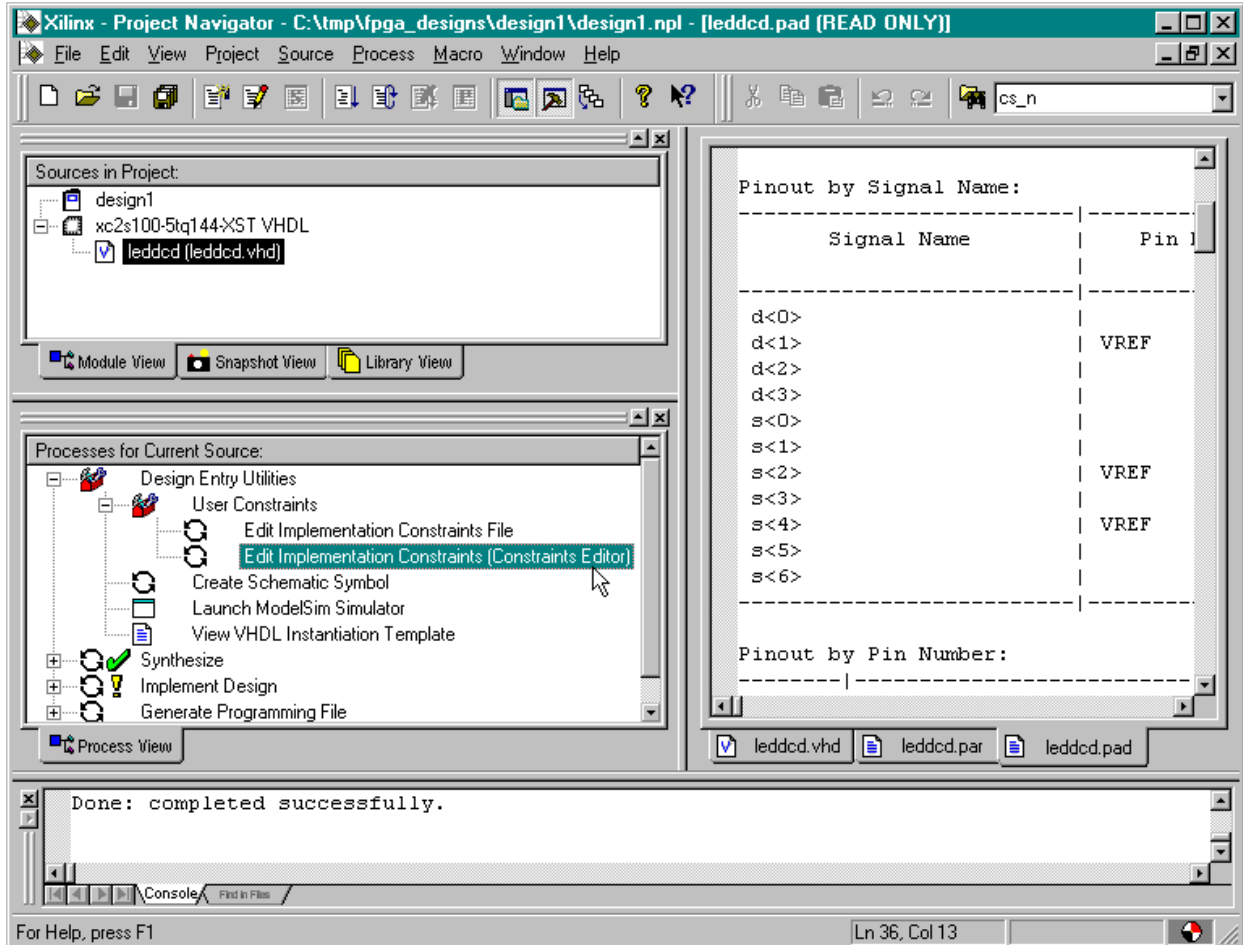

The **Constraints Editor** window appears. Click on the Ports tab in the upper pane. A list of the inputs and outputs for the LED decoder will appear. We can enter our pin assignments here.

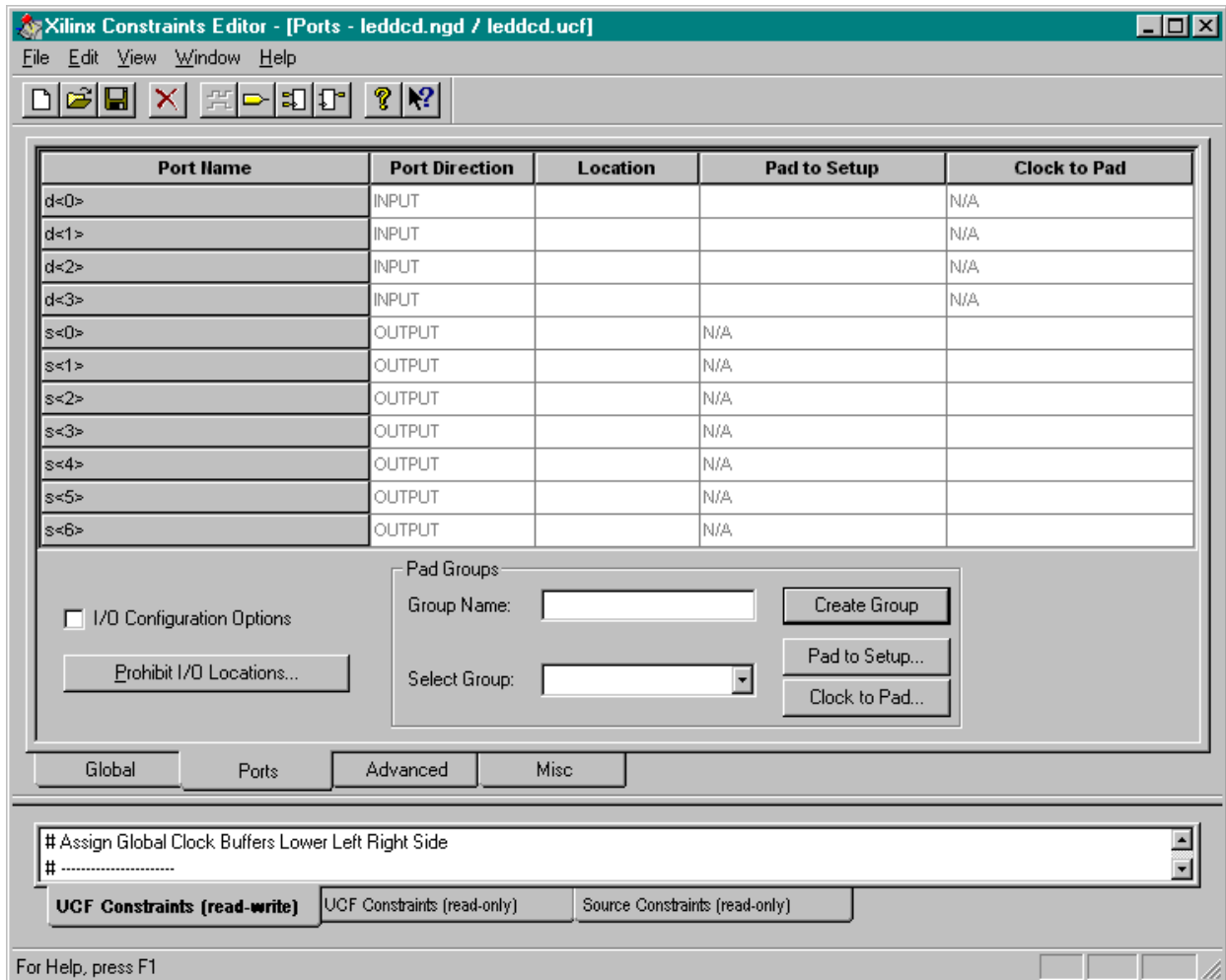



We start by clicking in the Location field for the **d<0>** input. Then just type in the pin assignment for this input: P50. Do this for each of the inputs and outputs using the pin assignments from the tables shown above. After doing this, the **Constraints Editor** window appears as follows.

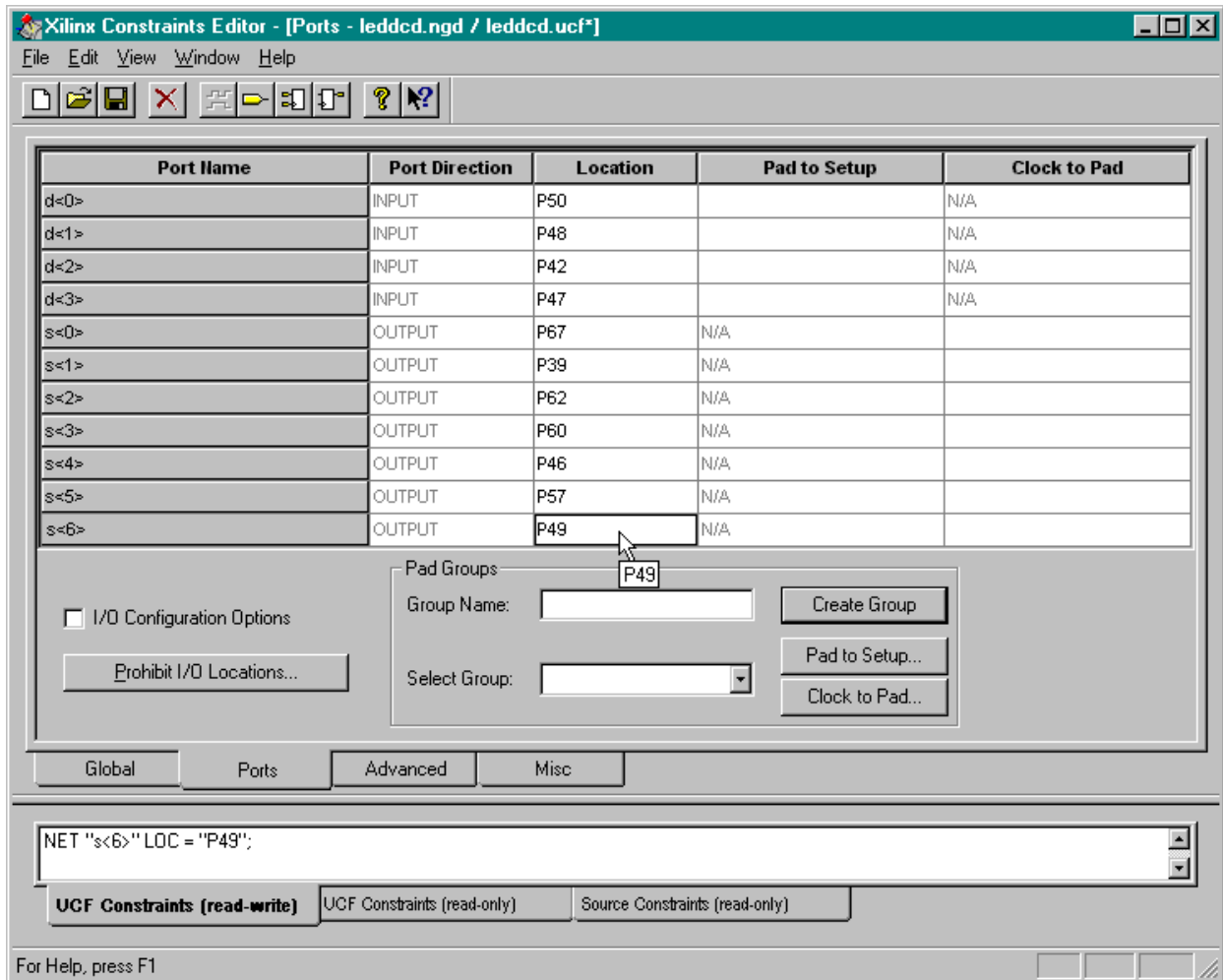

After the pin assignments are entered, click on the  button to save the pin assignment constraints. Then select File→Exit in the **Constraints Editor** window.

Since we are changing the constraints on our design, we are asked to reset the implementation process so it will be re-run with our new constraints. This just means we have to re-run the implementation process again if we want the design to use the pin assignments we just made. Click on Reset and then double-click the Implement Design process to re-fit the design with the new pin assignments.

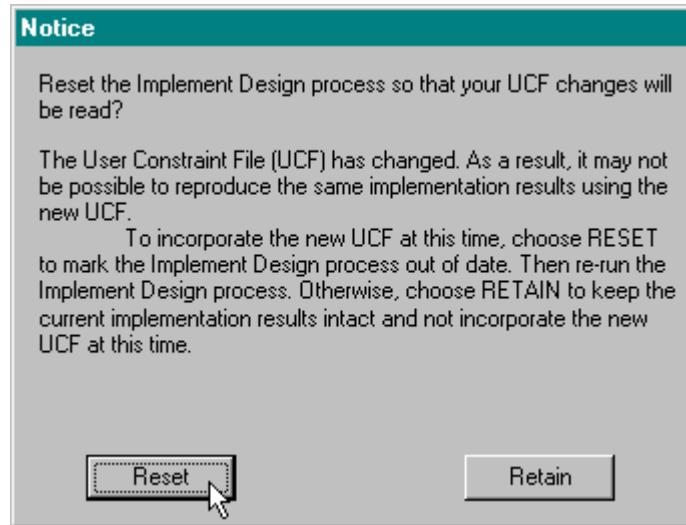

Next double-click on the Pad Report to view the pin assignments made during the implementation process. Now the pad report contains the following pin assignments:

Pinout by Signal Name:

Signal Name	Pin Name	Pin Number	Direction	IO Standard	IO Ban
d<0>	VREF	P50	INPUT	LVTTL	2
d<1>		P48	INPUT	LVTTL	2
d<2>		P42	INPUT	LVTTL	2
d<3>		P47	INPUT	LVTTL	2
s<0>	D7	P67	OUTPUT	LVTTL	3
s<1>	DIN_D0	P39	OUTPUT	LVTTL	2
s<2>	D6	P62	OUTPUT	LVTTL	3
s<3>	D5	P60	OUTPUT	LVTTL	3
s<4>	D2	P46	OUTPUT	LVTTL	2
s<5>	D4	P57	OUTPUT	LVTTL	3
s<6>	D3	P49	OUTPUT	LVTTL	2

The reported pin assignments match the assignments we made in the **Constraints Editor** window so it appears we accomplished what we wanted.

## Viewing the Chip

After the implementation process completes, you can get a graphical depiction of how the logic circuitry and I/O are assigned to the FPGA CLBs and pins. Just highlight the leddcd object in the Sources pane and then double-click the View/Edit Placed Design (FloorPlanner) process.

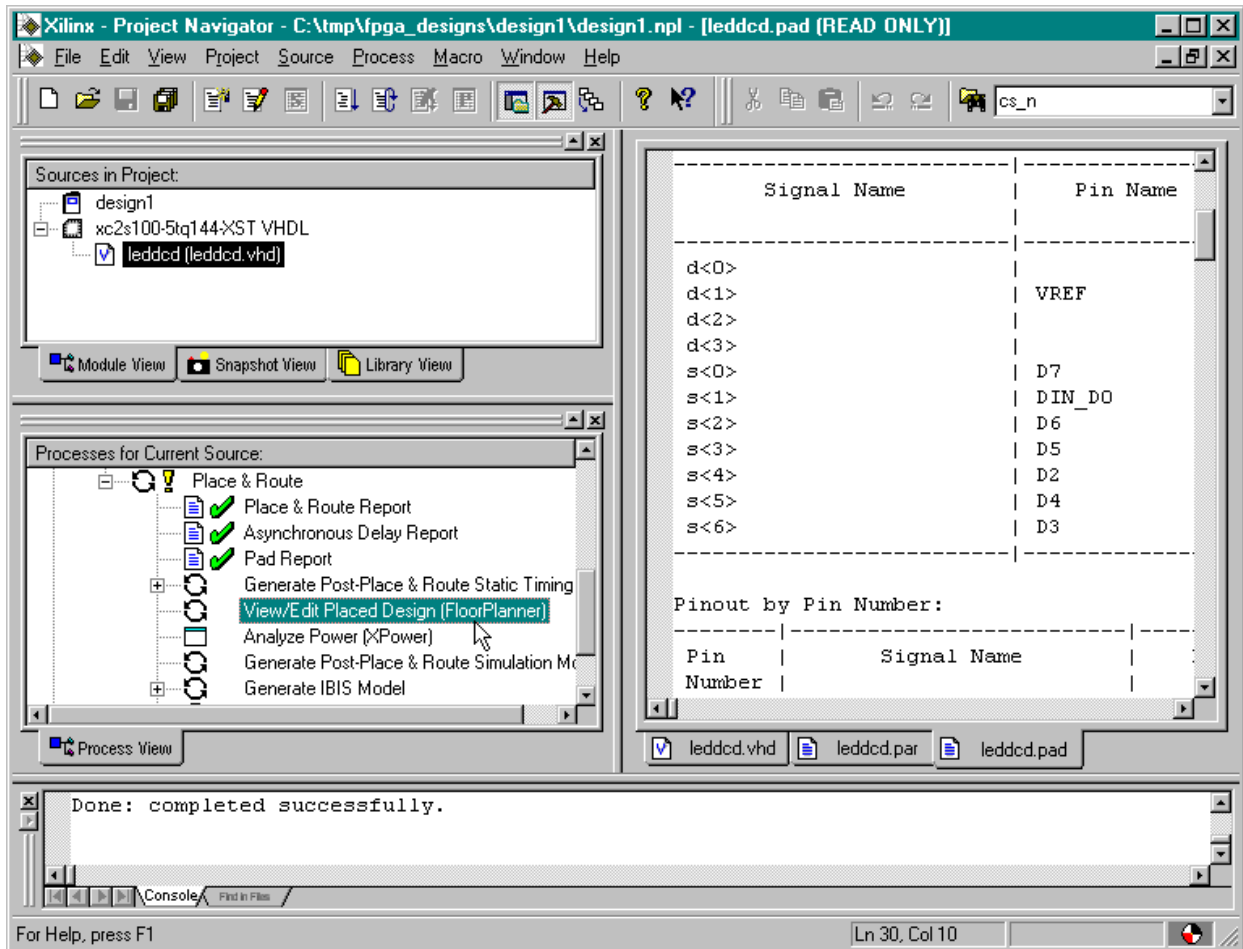

The **FloorPlanner** window will appear containing three panes:

1. The **Design Hierarchy** pane lists the LED decoder inputs, outputs and LUTs assigned to the various CLBs in the FPGA.
2. The **Design Nets** pane lists the various signal nets in the LED decoder.
3. The **Placement** pane shows the  $30 \times 20$  array of slices in the FPGA. The I/O pins are also shown around the periphery. (The pins used for Vcc, GND, and programming are not shown.)

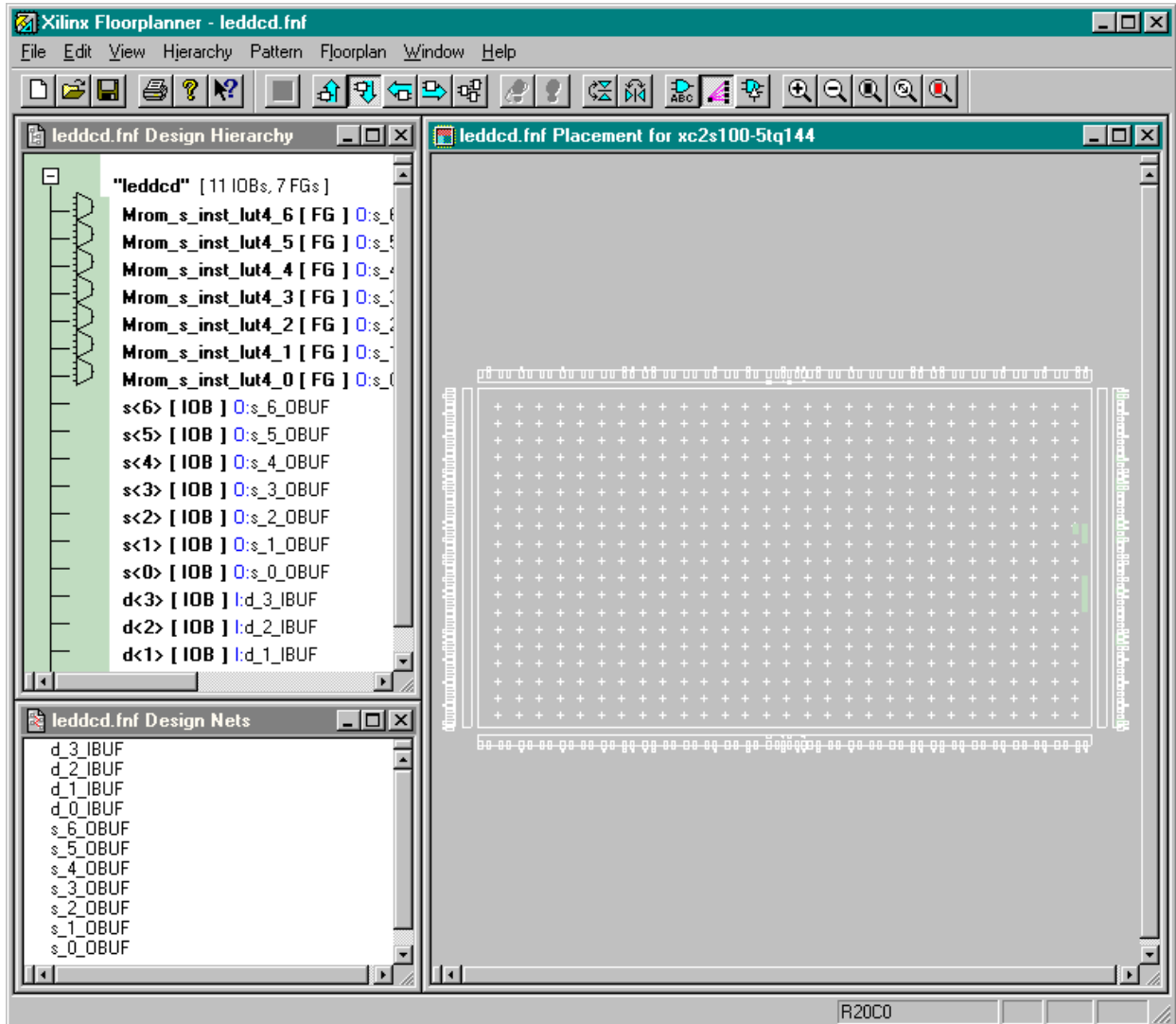

The CLBs used by the LED decoder circuit are highlighted in light-green and are clustered near the right-hand edge of the CLB array. To enlarge this region of the array, click on the  button and then draw a rectangle around the highlighted CLBs in the **Placement** pane. The enlarged view of the CLBs used by the LED decoder will appear as shown below.

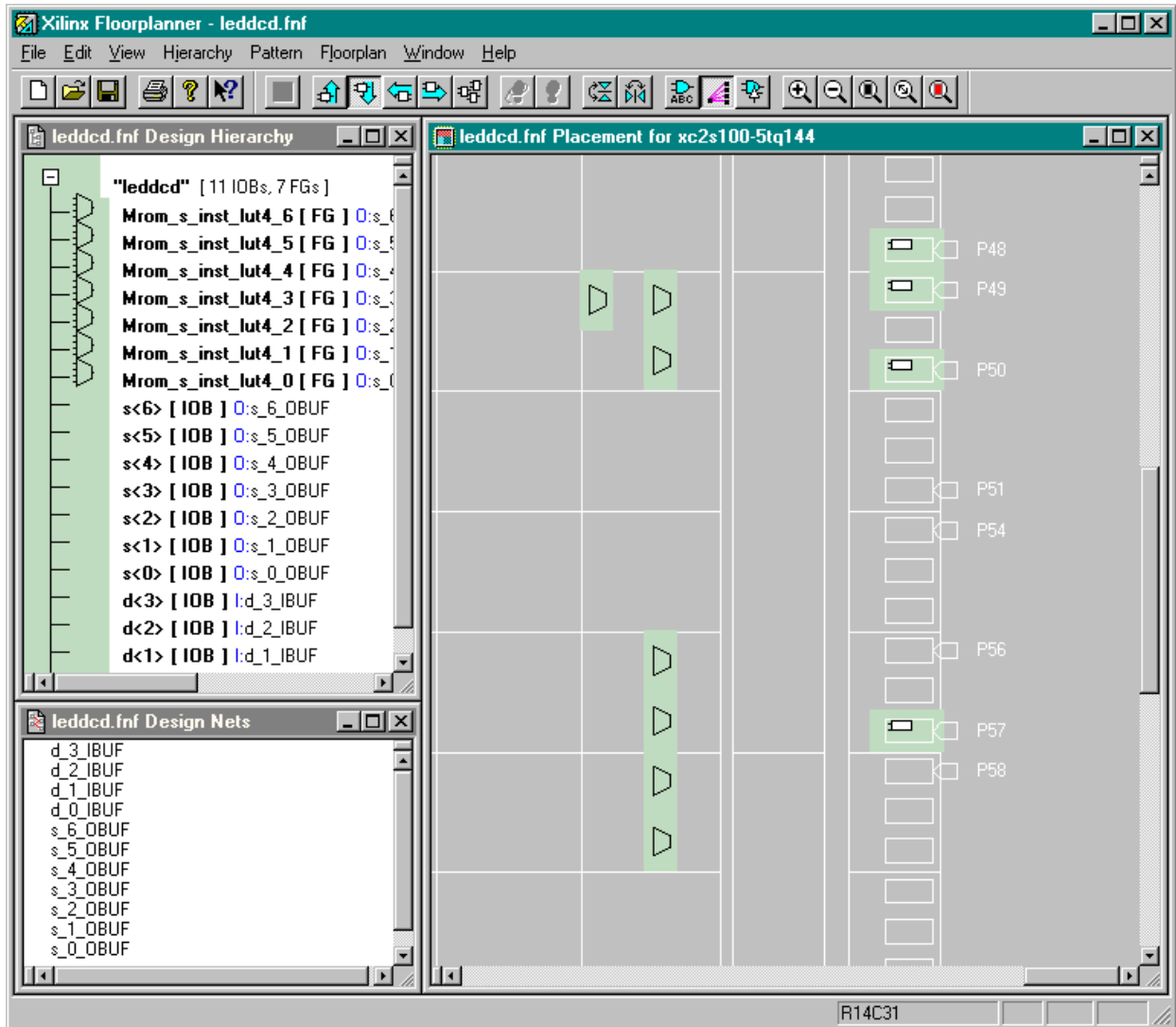

Clicking on a CLB will cause the inputs and output for the CLB to appear as shown below.

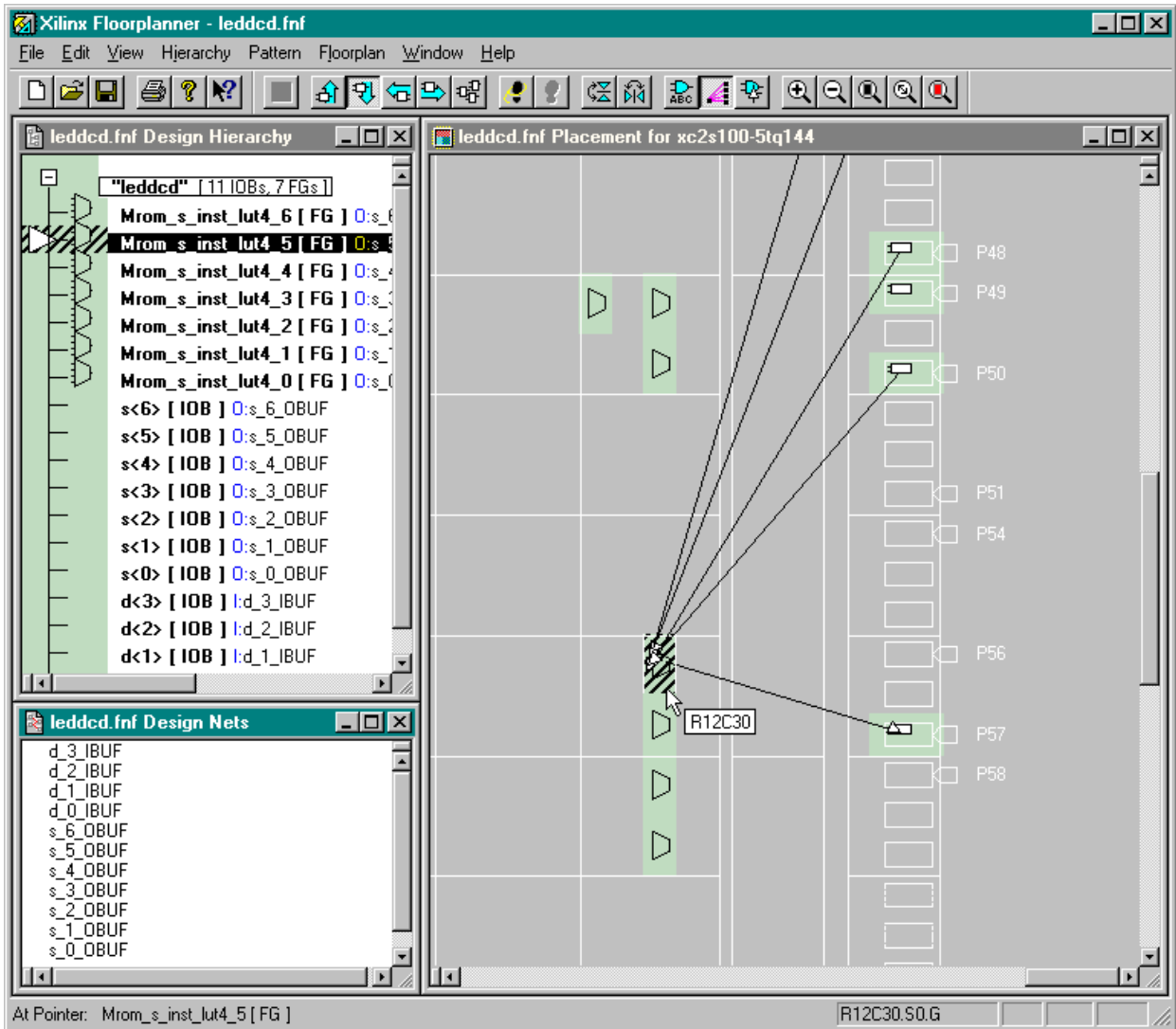

In an analogous manner, we can click on an input pin to highlight which CLBs are dependent on the input.

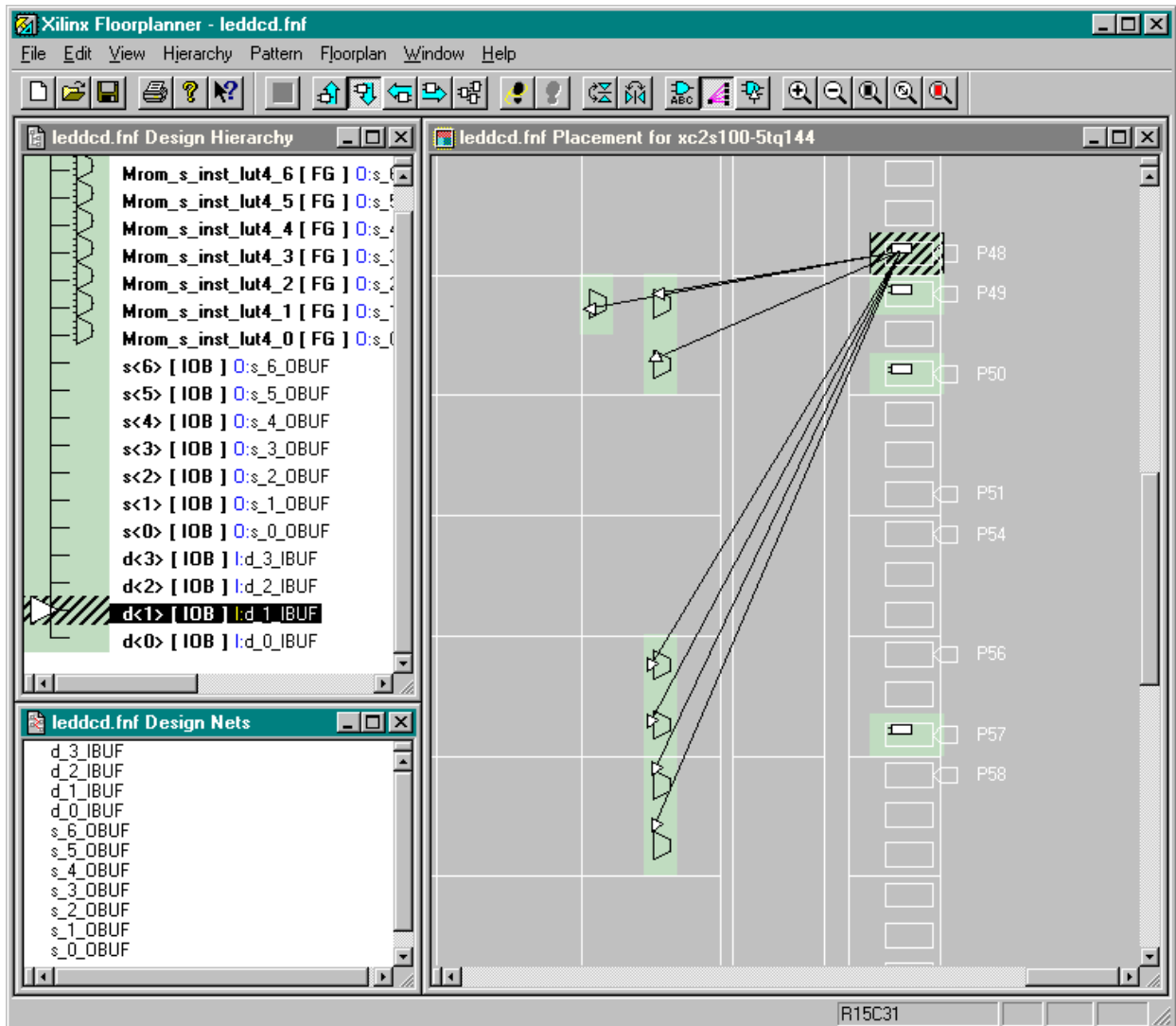

By default, the **Placement** pane only shows FPGA resources that are used by the design. To see all the logic resources in each CLB, click on View→Options... and check all the boxes as shown below.

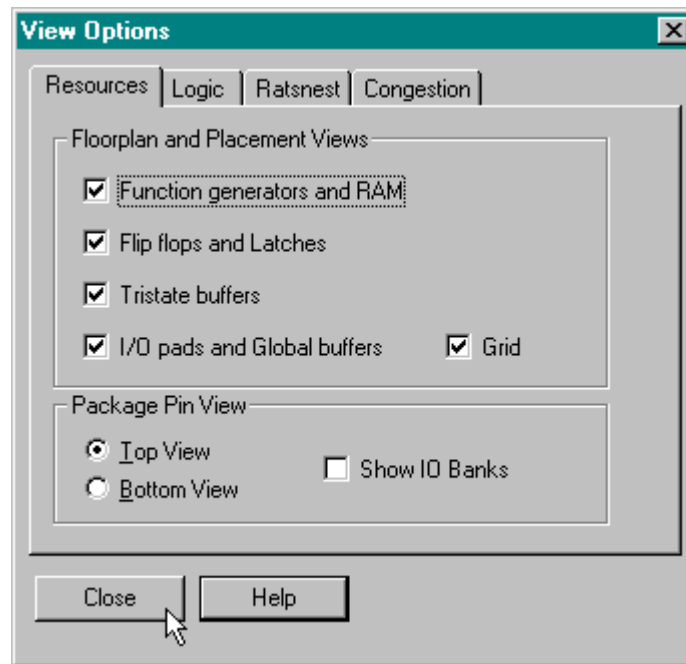



Now the **Placement** pane shows all the LUTs, flip-flops, carry-chains and tristate buffers included in each CLB.

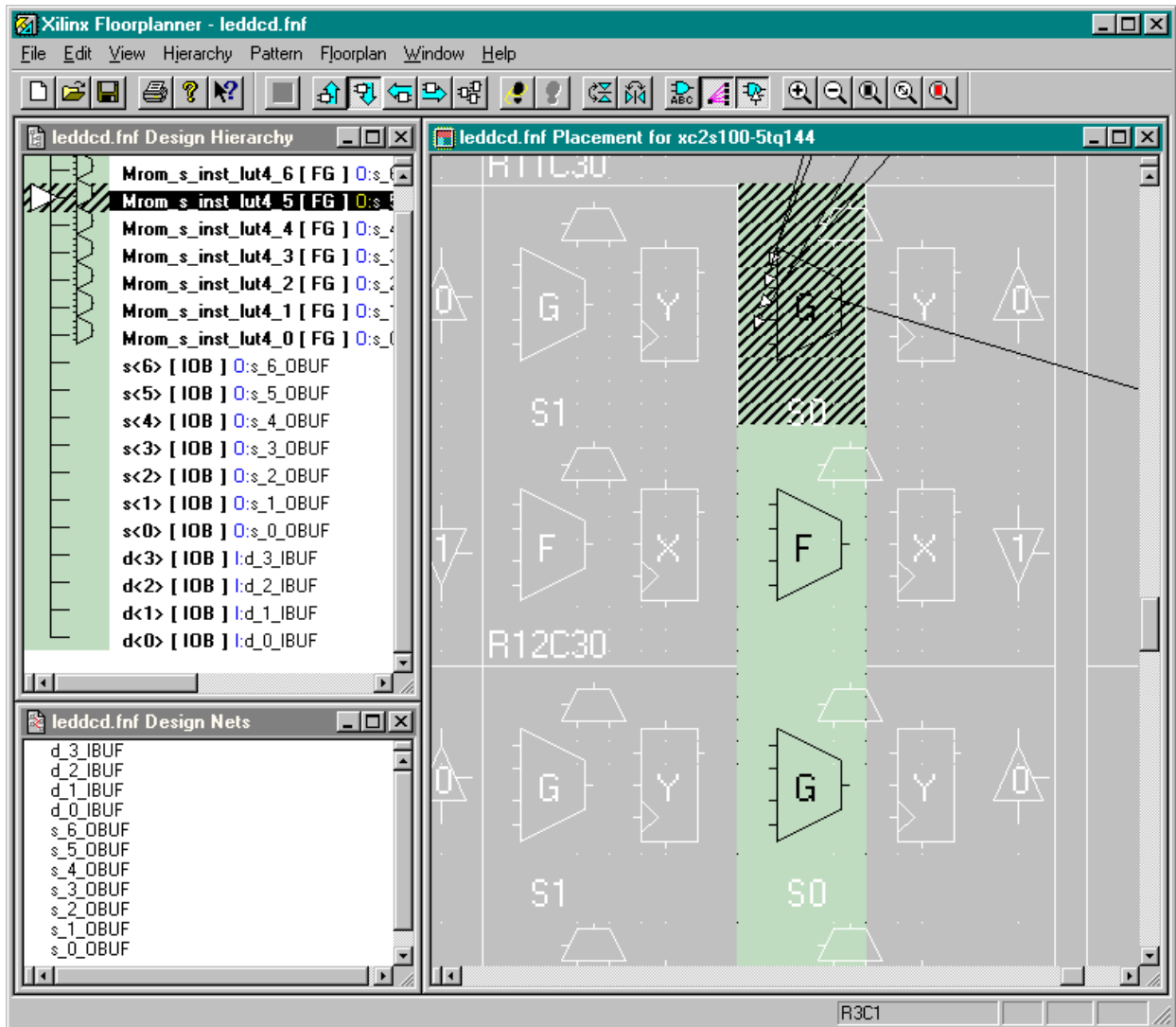

Viewing the placement of circuit elements after the place & route process can give you insights into the resource usage of certain VHDL language constructs. In addition to viewing the placement of the design, the Floorplanner can be used to re-arrange and optimize the placement. This is akin to the software technique of hand-optimizing assembly code output by a compiler. We won't do this here, but it is an option for designs which push at the extremes of the capabilities of FPGAs.

## Generating the Bitstream

Now that we have synthesized our design and mapped it to the FPGA with the correct pin assignments, we are ready to generate the bitstream that is used to program the actual chip. To initiate the programmer, we highlight the leddcd object in the Sources pane and double-click on the Generate Programming File process.

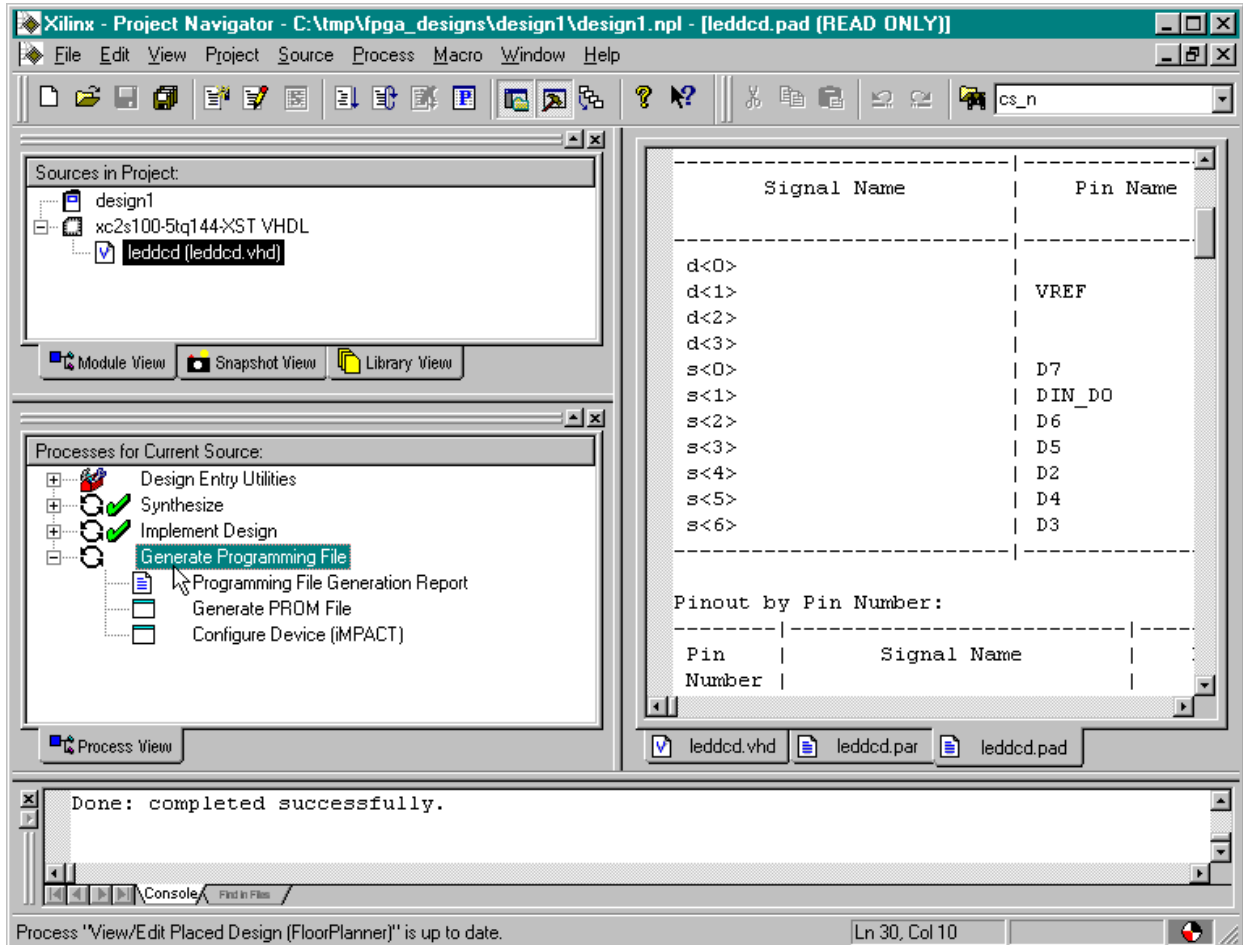

Within a few seconds, a  will appear next to the Generate Programming File process and a file detailing the bitstream generation process will be created. A bitstream file named leddcd.bit can now be found in the design1 folder.

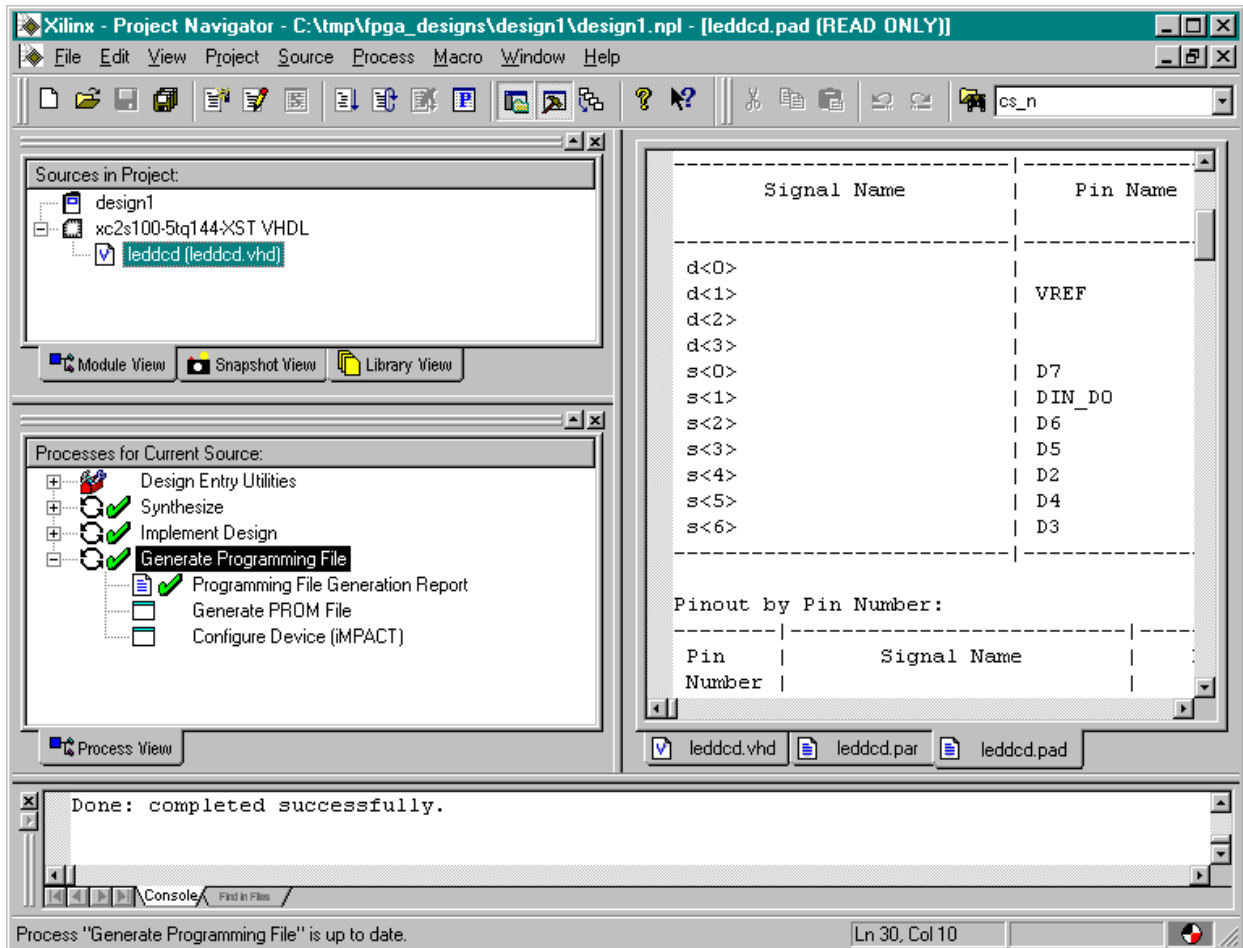

## Downloading the Bitstream

Now we have to get the bitstream file programmed into the FPGA on the XSA Board. The XSA Board is powered with a 9 VDC power supply and is attached to the PC parallel port with a standard 25-wire cable as shown below.

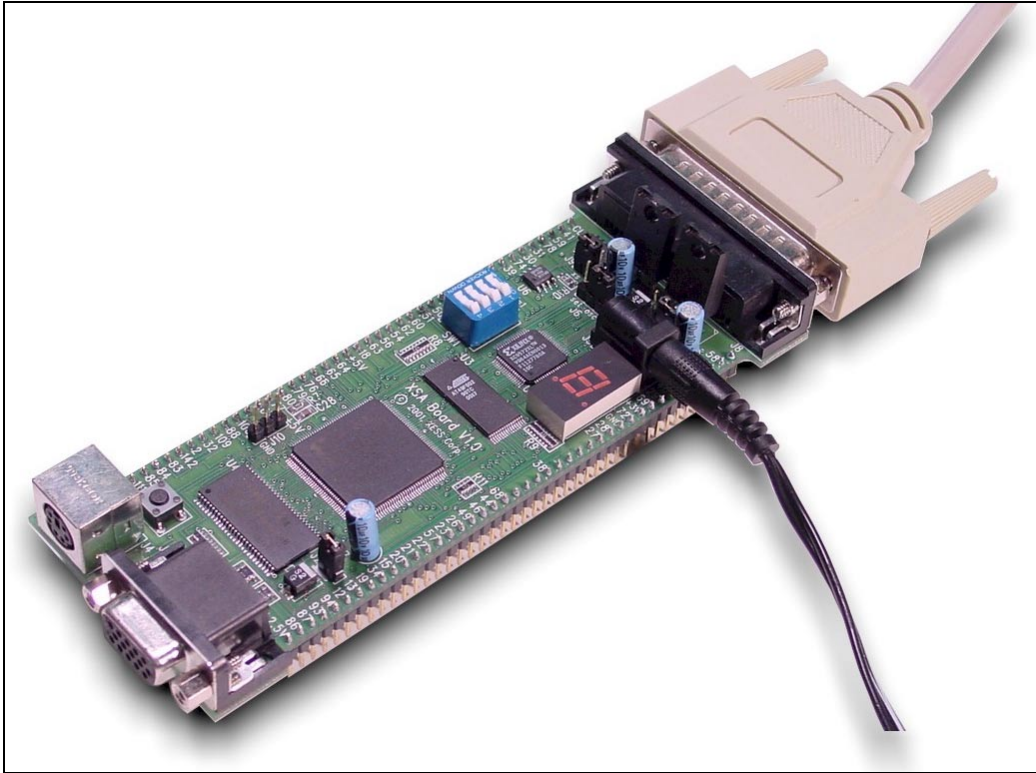



The XSA Board is programmed using the gxslod utility. We double click the  icon to bring up the following window:

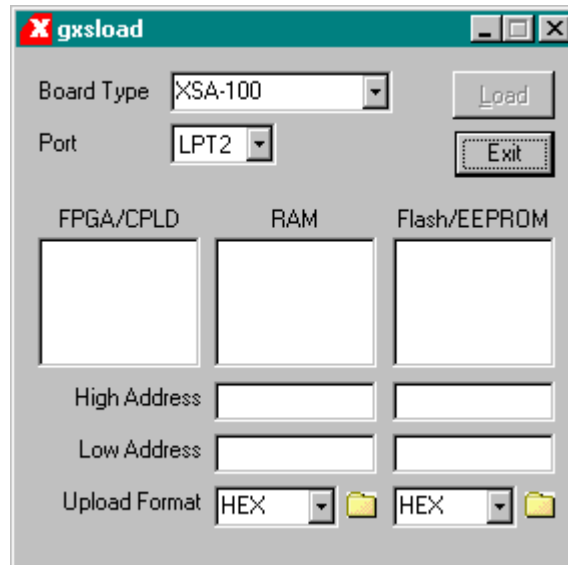

Then we open a window that shows the contents of the folder where we have stored our LED decoder design (C:\tmp\fpga\_designs in this case). We just drag the leddcd.bit file from the **design1** window into the **gxslod** window.

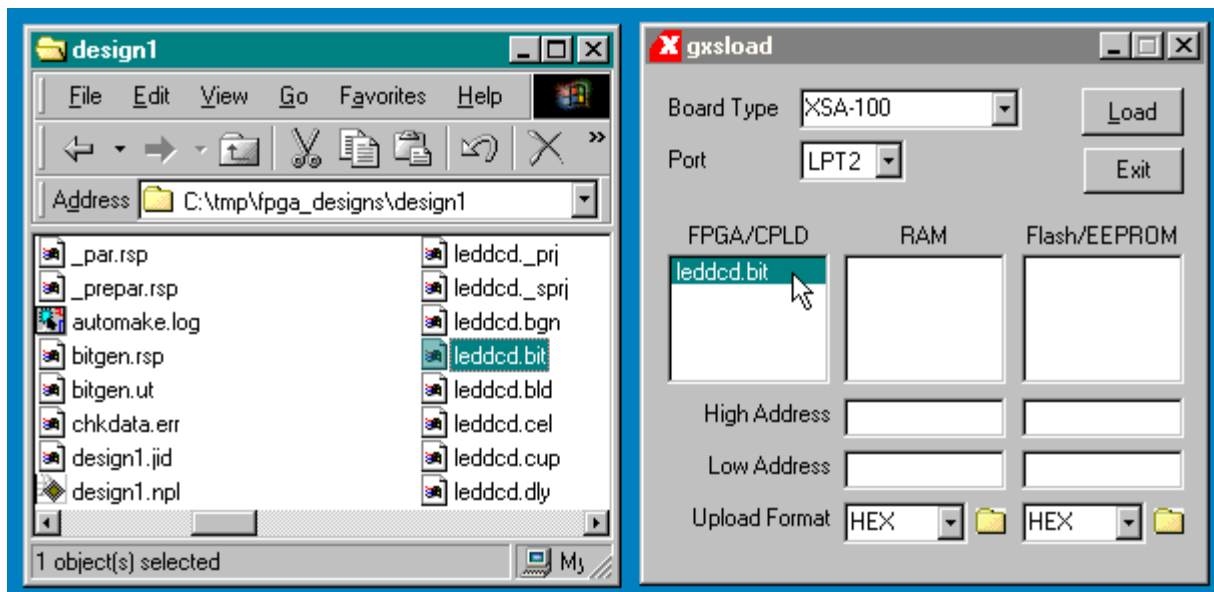

Then we click on the Load button to initiate the programming of the XSA Board. Downloading the leddcd.bit file will take a few seconds.

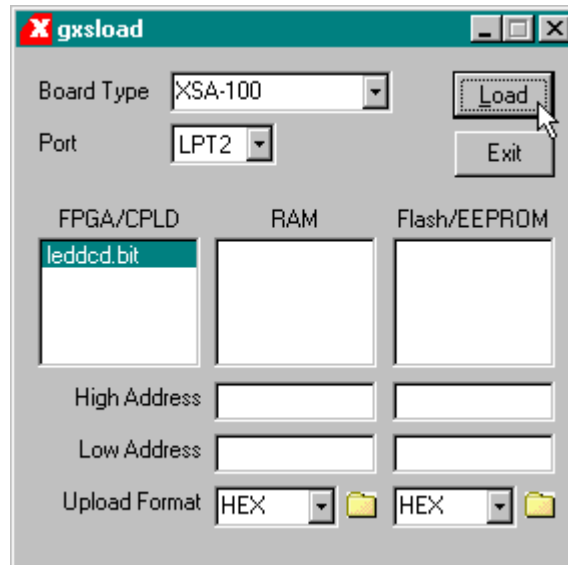

## Testing the Circuit

Once the FPGA on the XSA Board is programmed, we can begin testing the LED decoder. The eight data pins of the PC parallel port connect to the FPGA through the downloading cable. We have assigned the inputs of the LED decoder to pins which are connected to the parallel port data pins. The gxsport utility lets us control the logic values on these pins. By placing different bit patterns on the pins, we can observe the outputs of the LED decoder through the seven-segment LED on the XSA Board.



Double-clicking the  icon initiates the gxSPORT utility. The **d0**, **d1**, **d2**, and **d3** inputs of the LED decoder are assigned to the pins controlled by the D0, D1, D2, and D3 buttons of the **gxSPORT** window. To apply a given input bit pattern to the LED decoder, click on the D buttons to toggle their values. Then click on the Strobe button to send the new bit pattern to the pins of the parallel port and on to the FPGA. For example, setting (D3,D2,D1,D0) = (1,1,1,0) will cause E to appear on the seven-segment LED of the XSA Board.

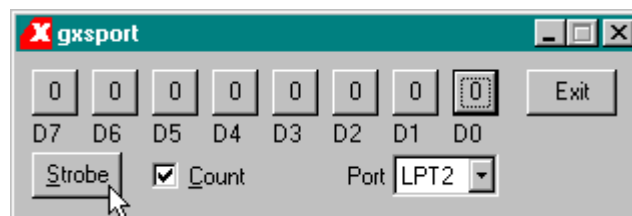

If you check the Count box in the **gxsport** window, then each click on the Strobe button increments the eight-bit value represented by D7-D0. This makes it easy to check all sixteen input combinations.

## 4

# Hierarchical Design

## A Displayable Counter

We went through a lot of work for our first FPGA design, so we will reuse it in this design: a four-bit counter whose value is displayed on a seven-segment display. The counter will increment on a rising edge of the clock. The four-bit output from the counter enters the LED decoder whereupon the counter value is displayed on the seven-segment LED. A high-level diagram of the displayable counter looks like this:

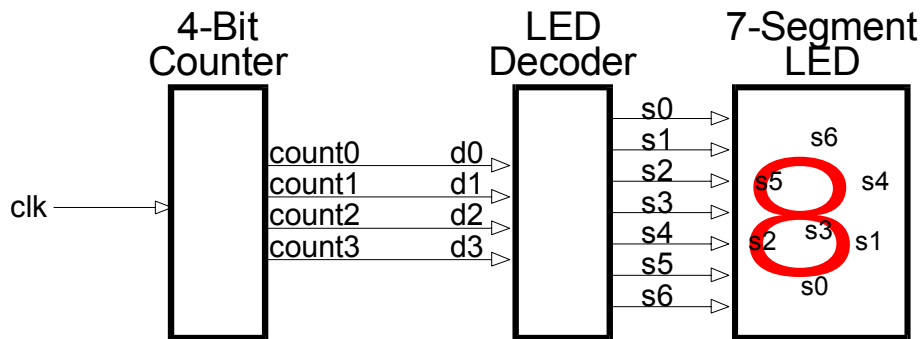

This design is hierarchical in nature. The LED decoder and counter are modules which are interconnected within a top-level module.



## Starting a New Design

We can start a new project using the File→New Project... menu item. We name the project **design2** and store it in the same folder as the previous design: C:\tmp\fpga\_designs. The other properties in the **New Project** window retain the same values we set in the previous project.

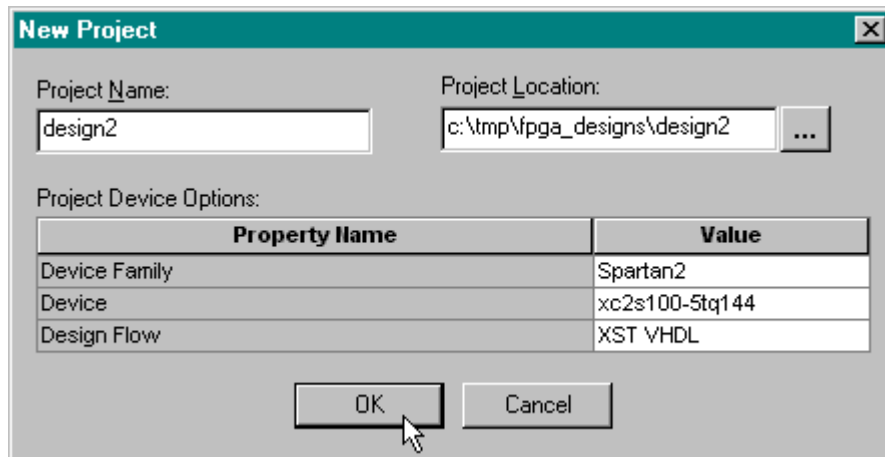

Once we click on OK in the **New Project** window, the **Project Navigator** window appears as shown below.

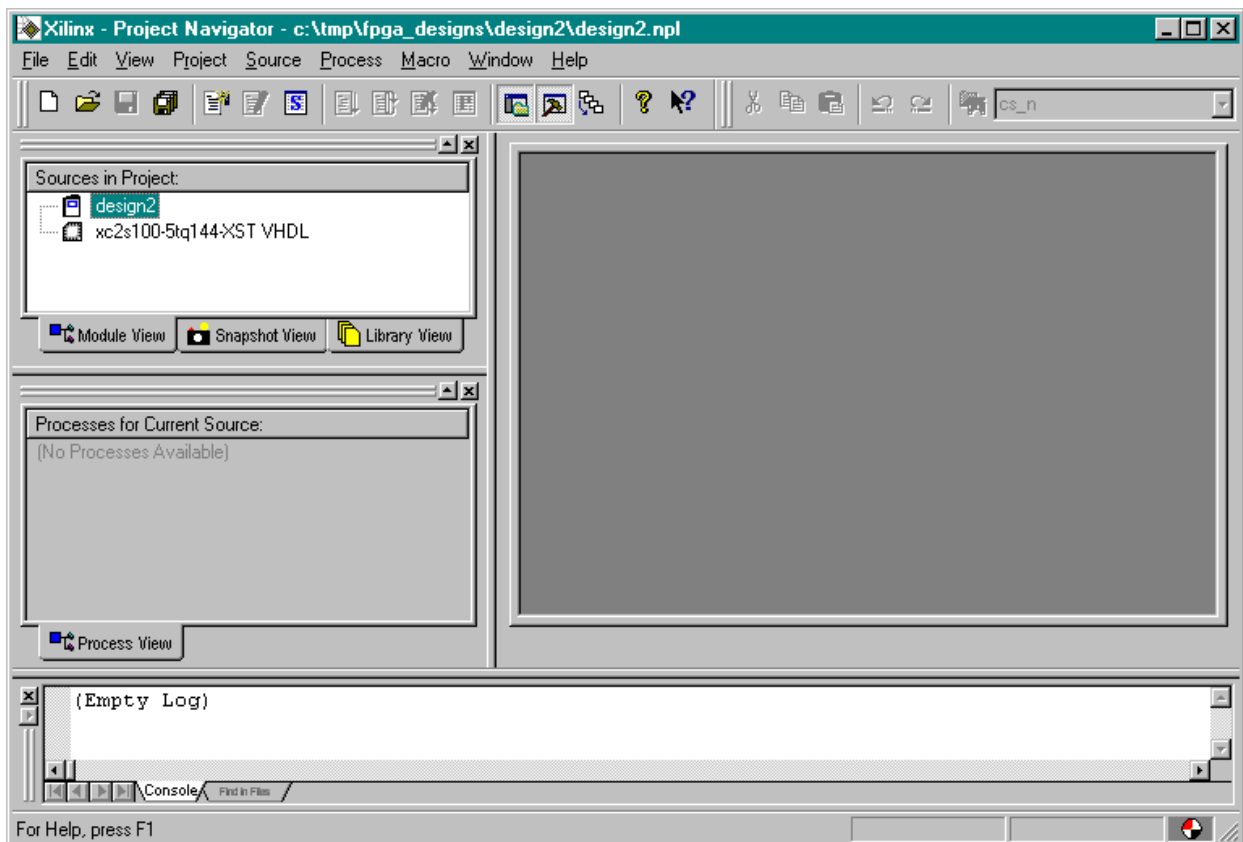

## Adding the LED Decoder

The first thing we do after getting the **design2** project started is to add the LED decoder module. We do this by right-clicking on the xc2s100-5tq144 object in the Sources pane and selecting Add Source ... from the pop-up menu.

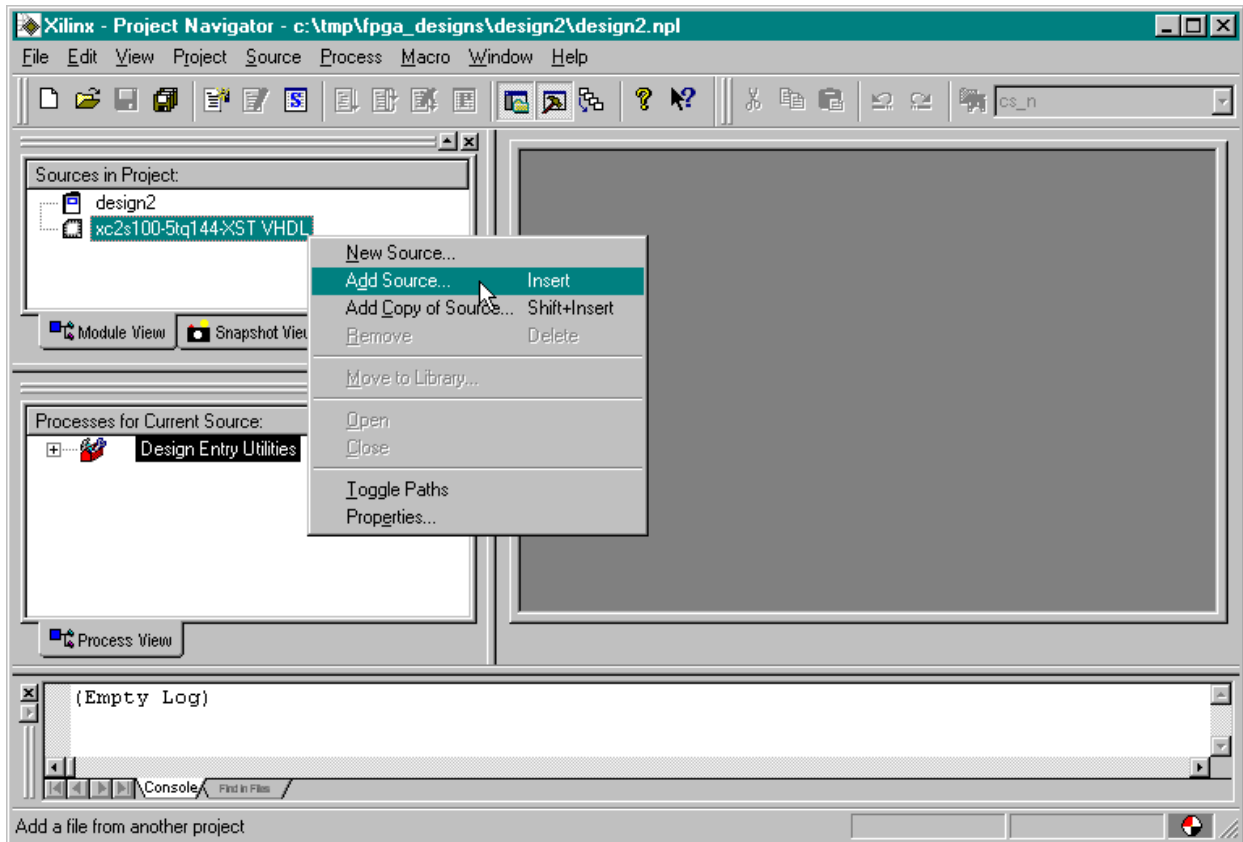

The **Add Existing Sources** window appears and we move to the C:\tmp\pga\_designs\design1 folder. Then we highlight the leddcd.vhd file that contains the VHDL source code for the LED decoder.

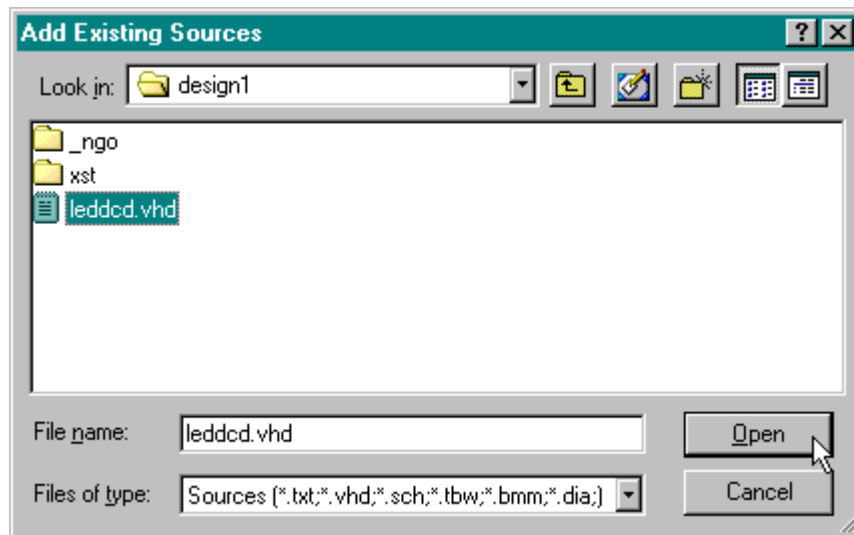

After clicking on Open, a window appears that asks us the type of file we are adding to the project.

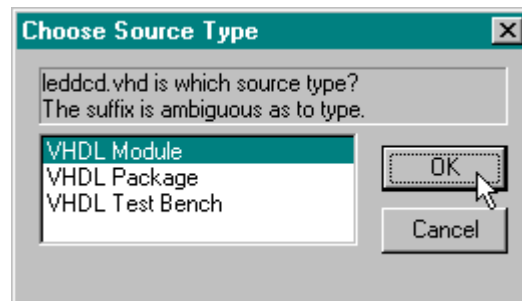

We select VHDL Module since the leddcd.vhd file contains a standard VHDL description of a circuit. (Packages contain extra syntactical elements for modules meant to be used as a library. Test benches contain VHDL code that exercises other VHDL modules through a sequence of tests.) After clicking OK, we see that the LED decoder module has been added to the Source pane of the **Project Navigator** window on the next page.

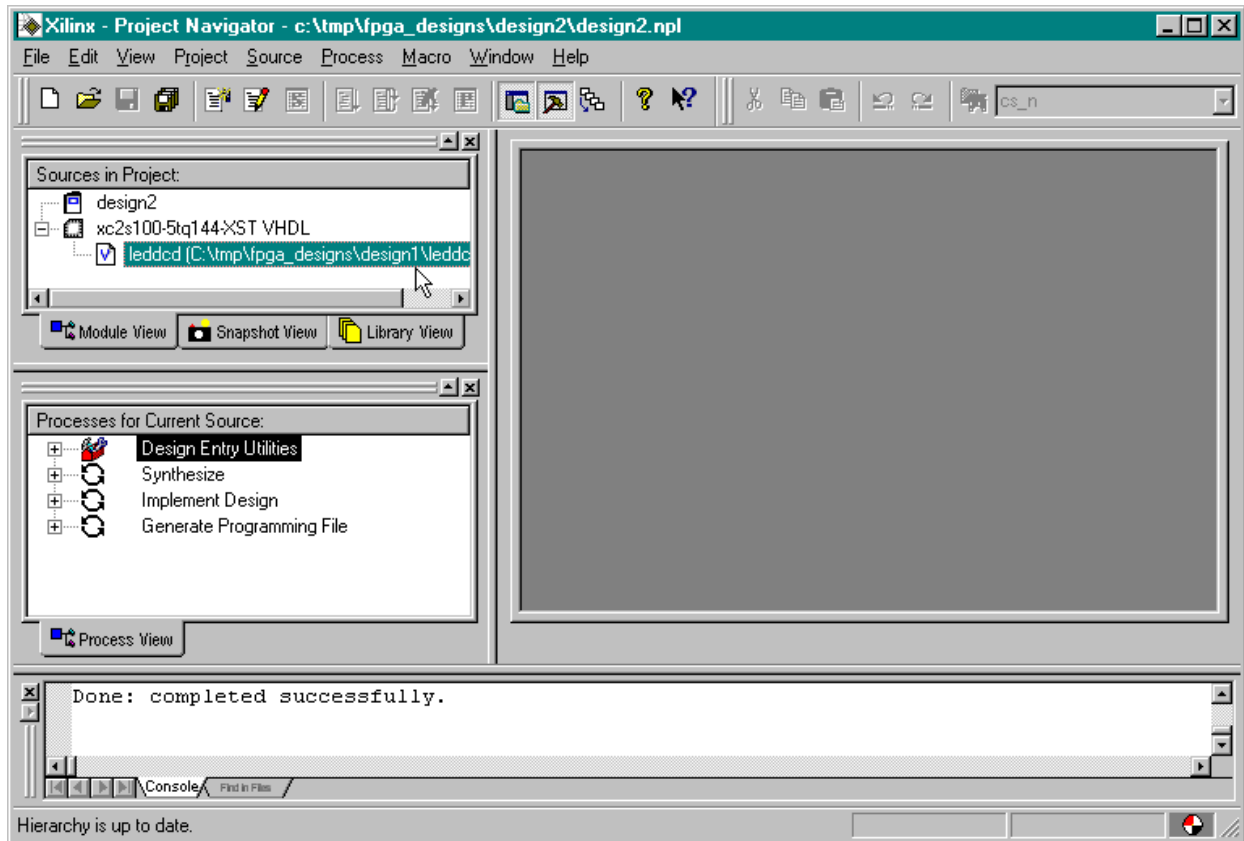

## Adding a Counter

Now we have to add the counter to our design. We don't have a counter module yet, so we have to build one with VHDL. Right-click on the xc2s100-5tq144 object and select New Source... from the pop-up menu.

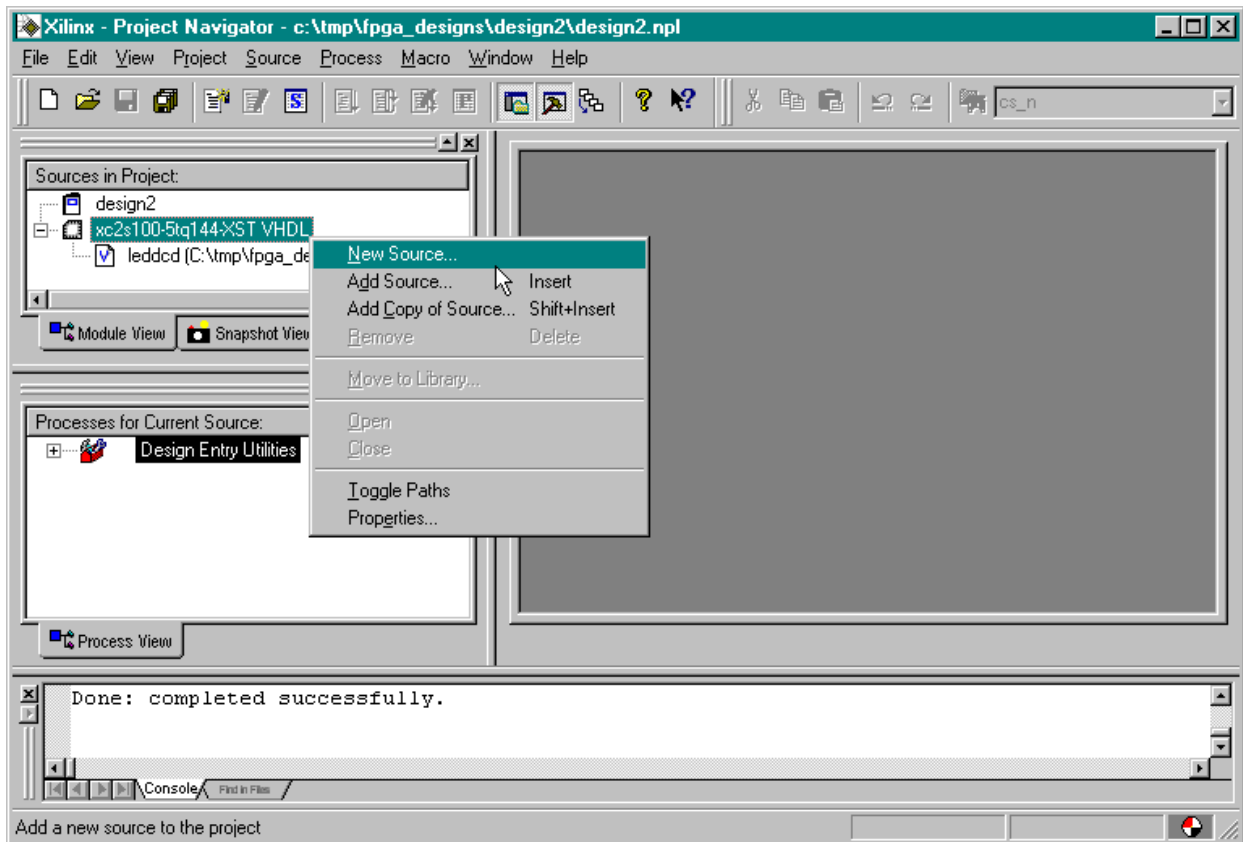

As in the previous example, we are prompted for the type of file we want to add to the project. Once again, we select the VHDL Module menu item. Then we type `counter` into the File Name field and click on the Next button.

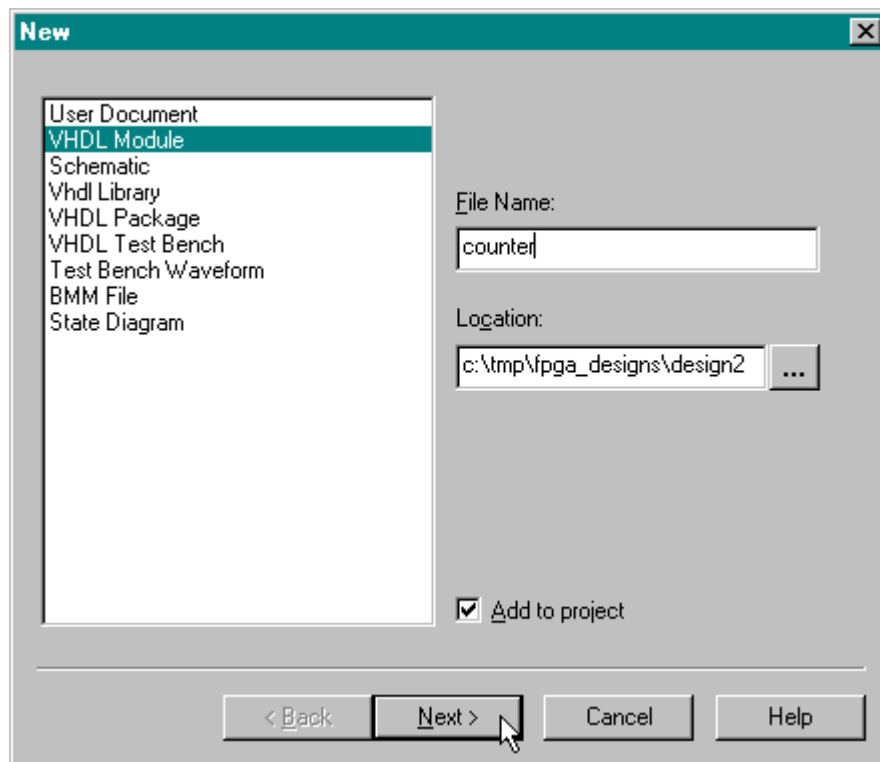

Then we declare the inputs and outputs for the counter in the **Define VHDL Source** window as shown below. The **counter** module receives a single input, **clk**, and has a four-bit output bus, **count**, which outputs the current counter value.

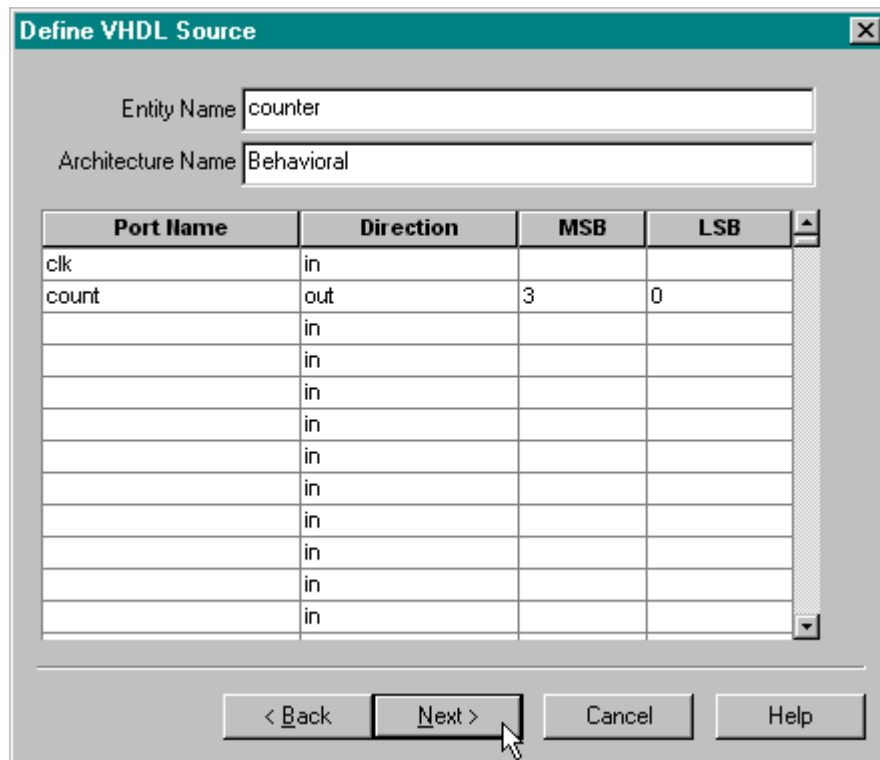

Click on Next and check the information about the module.

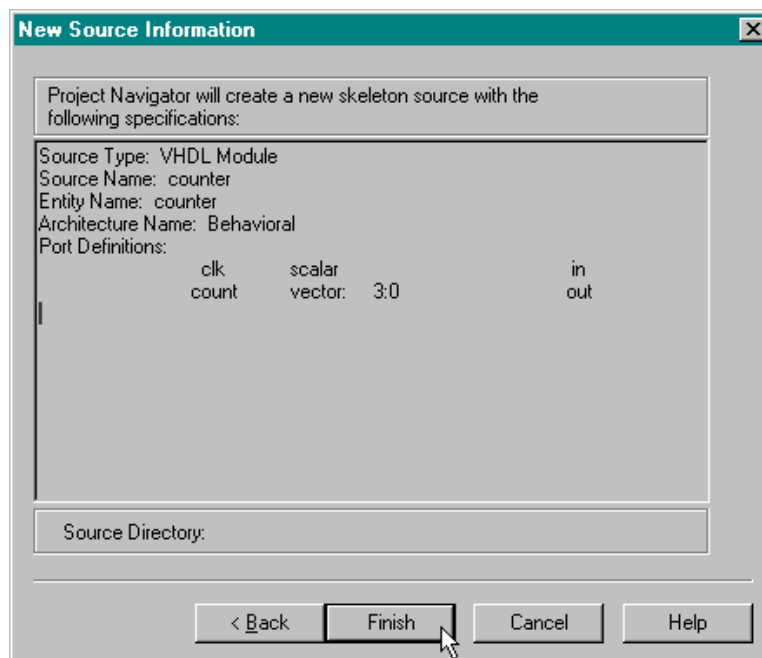

After clicking Finish in the **New Source Information** window, we are presented with a VHDL skeleton for the counter. We flesh-out the skeleton as follows:

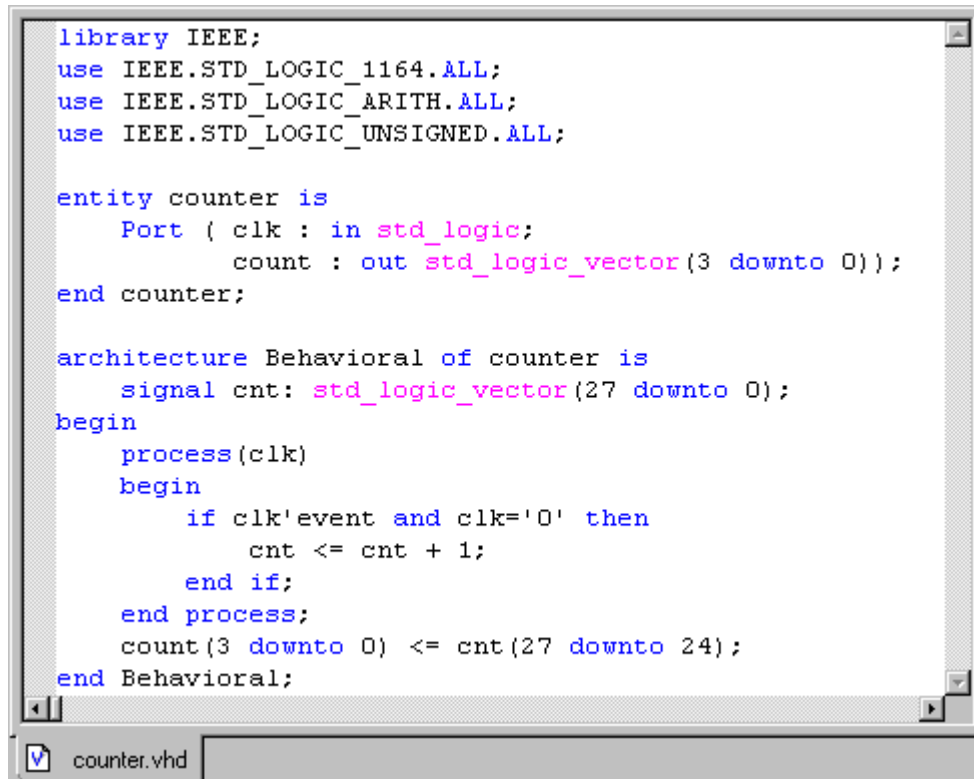

```
library IEEE;
use IEEE.STD_LOGIC_1164.ALL;
use IEEE.STD_LOGIC_ARITH.ALL;
use IEEE.STD_LOGIC_UNSIGNED.ALL;

entity counter is
    Port ( clk : in std_logic;
          count : out std_logic_vector(3 downto 0));
end counter;

architecture Behavioral of counter is
    signal cnt: std_logic_vector(27 downto 0);
begin
    process(clk)
    begin
        if clk'event and clk='0' then
            cnt <= cnt + 1;
        end if;
    end process;
    count(3 downto 0) <= cnt(27 downto 24);
end Behavioral;
```

Line 12 declares a 28-bit signal, **cnt**, that is the current value of the counter. The process on lines 15-20 controls when counter increments. The condition clause of line 16 is only true when the value on the **clk** input goes from 0 to 1. Then the statement on line 17 replaces the value in **cnt** with its incremented value. (We can use the high-level addition operator instead of having to describe a 28-bit adder because on line 4 we have linked into the `ieee.std_logic_unsigned.all` package that supports unsigned arithmetic.) Finally, line 22 places the upper four bits of the current counter value onto the outputs of the module.

Why are we building a 28-bit counter and using only the upper four bits? The counter will be driven by the oscillator on the XSA Board which has a default frequency of 50 MHz. The LED display would be changing much too quickly at this frequency. By connecting the LED decoder to the upper four bits of the 28-bit counter, the display will only change once in every  $2^{24}$  clock cycles. So the LED display will change every  $2^{24} / (50 \times 10^6) = 0.336$  seconds which is slow enough to be seen.



After entering the VHDL shown above and saving it, we see that the counter module has been added to the Sources pane of the **Project Navigator** window.

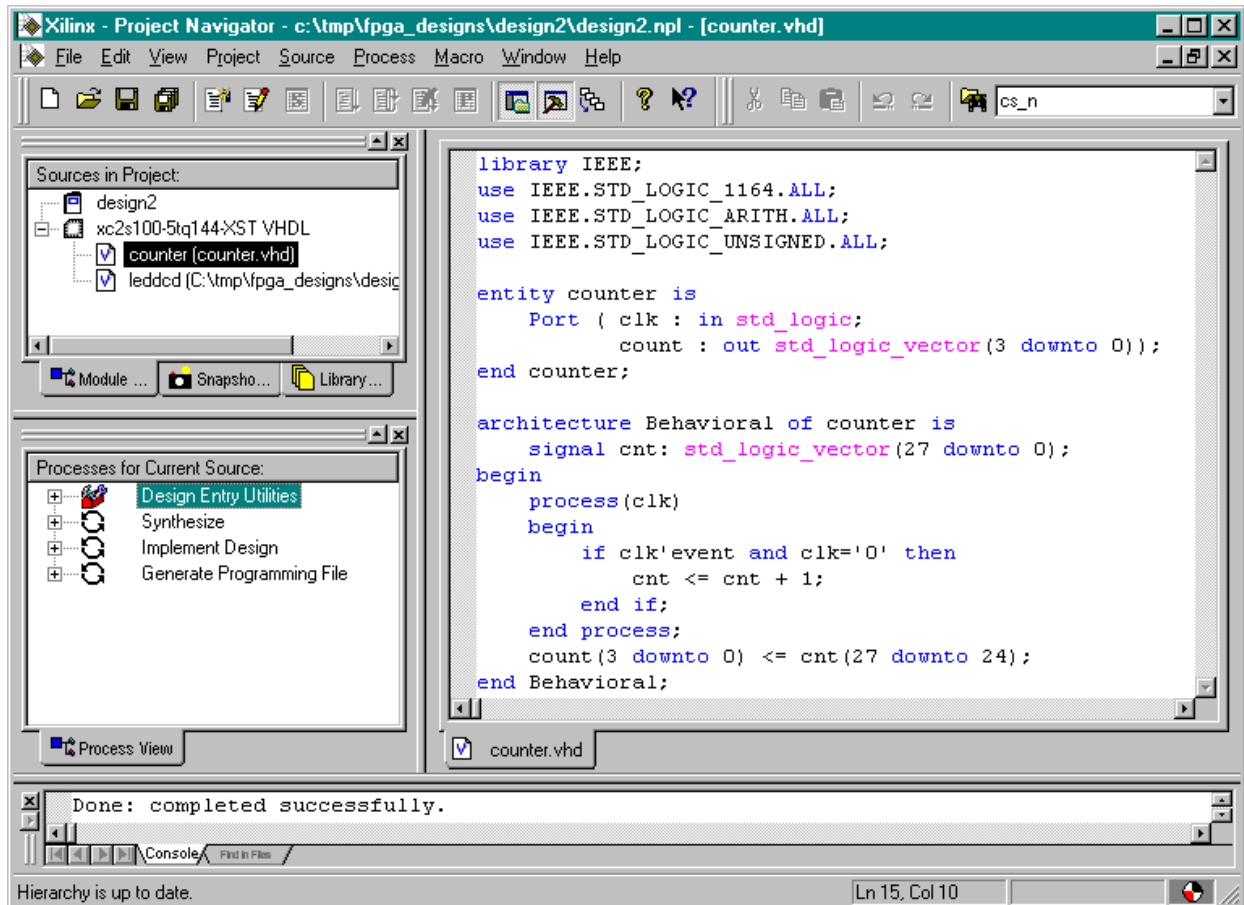

## Tying Them Together

We have the LED decoder and the counter, but now we need to tie them together to build the displayable counter. We will do this by connecting the counter to the LED decoder in a top-level schematic. Before we can do this, we have to create schematic symbols for both the counter and LED decoder modules. To create the counter schematic symbol, highlight the counter object in the Sources pane and then double-click the Create Schematic Symbol process.

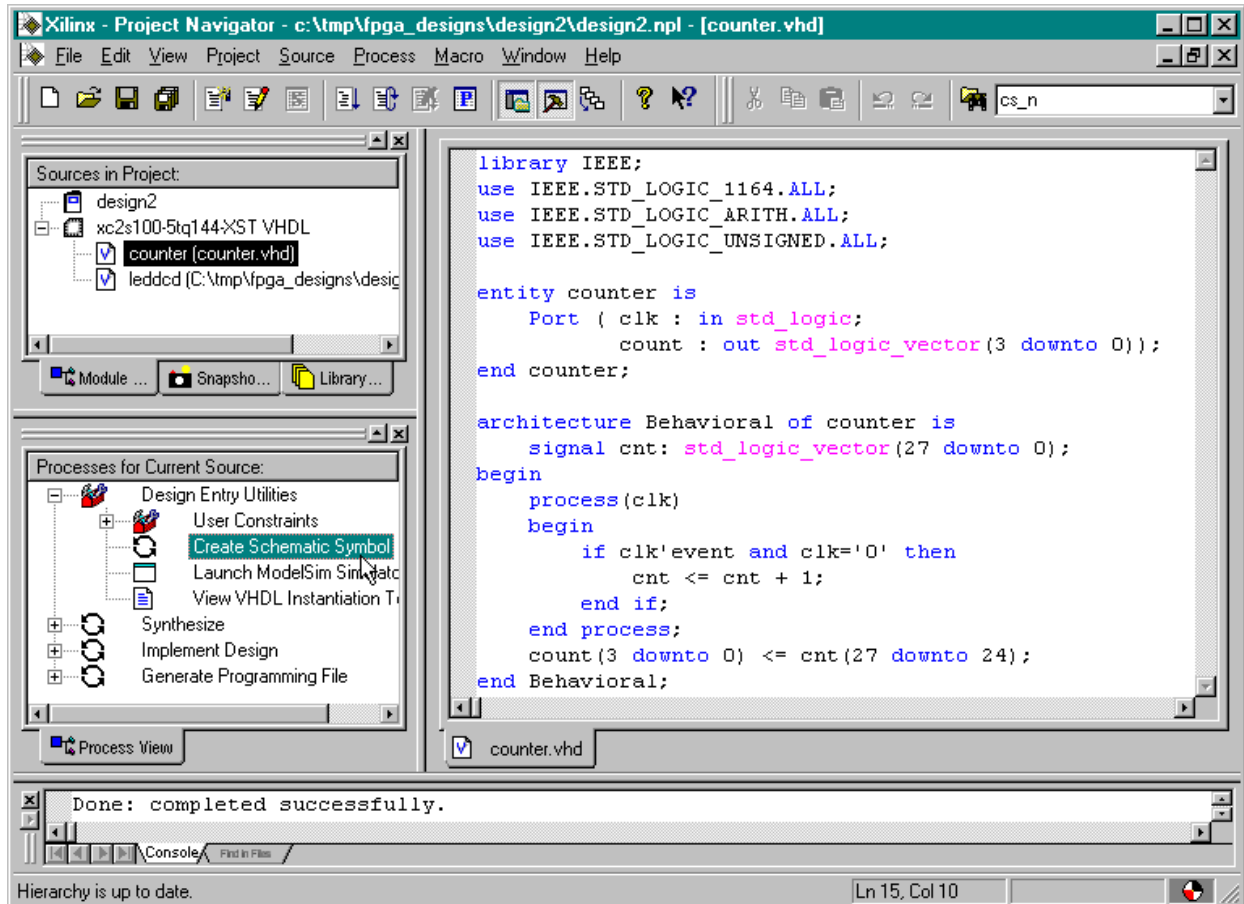

A will appear next to the Create Schematic Symbol process after the symbol is created. Repeat this procedure to create the schematic symbol for the LED decoder.

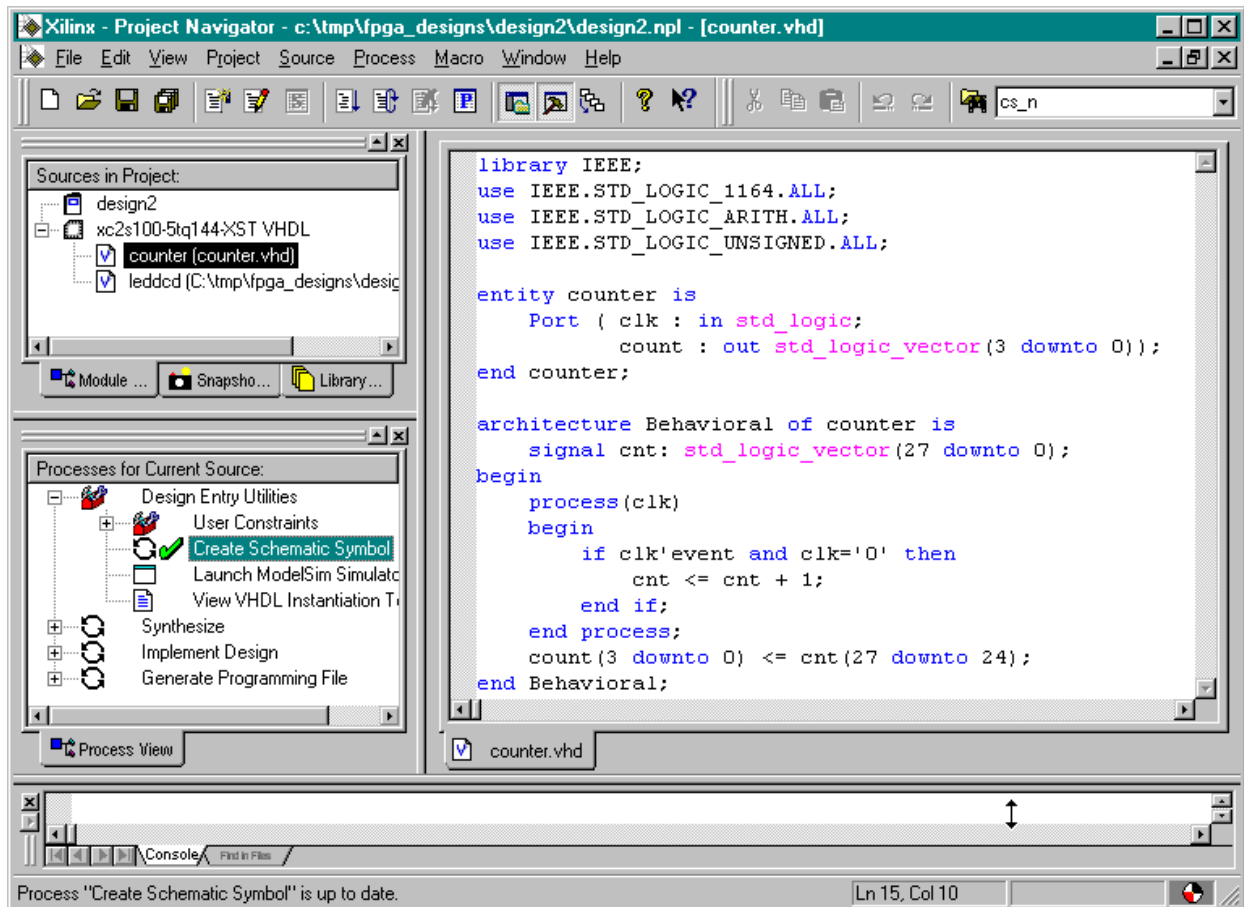

Once the schematic symbols for the lower-level modules are built, we can add the top-level schematic to the project. Right-click on the xc2s100-5tq144 object and select New Source... from the pop-up menu. Then highlight the Schematic entry in the **New** window and name the schematic **disp\_cnt**. Then click on Next.

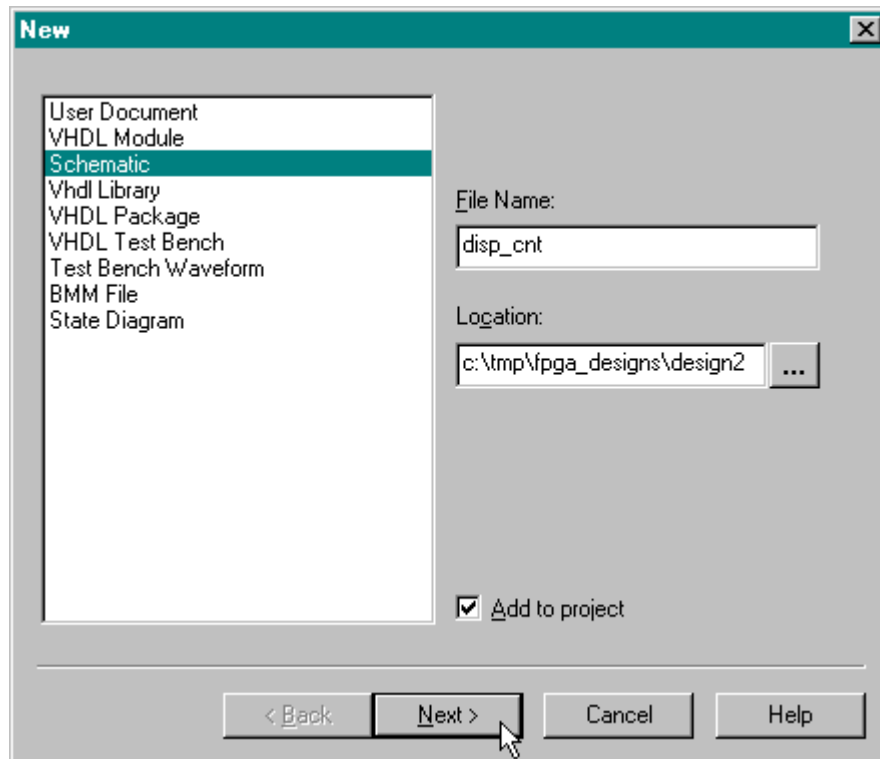

There is very little to do when setting-up a schematic, so just click on the Finish button in the **New Source Information** window that appears.

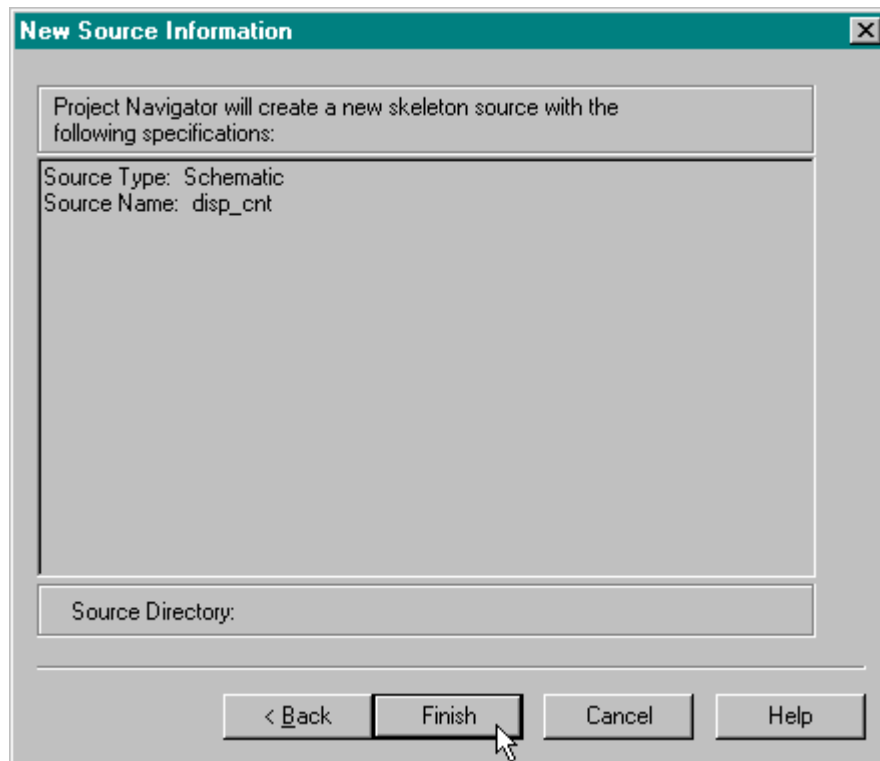

Now the disp\_cnt schematic object has been added to the Sources pane. Double-click it to open a schematic window.

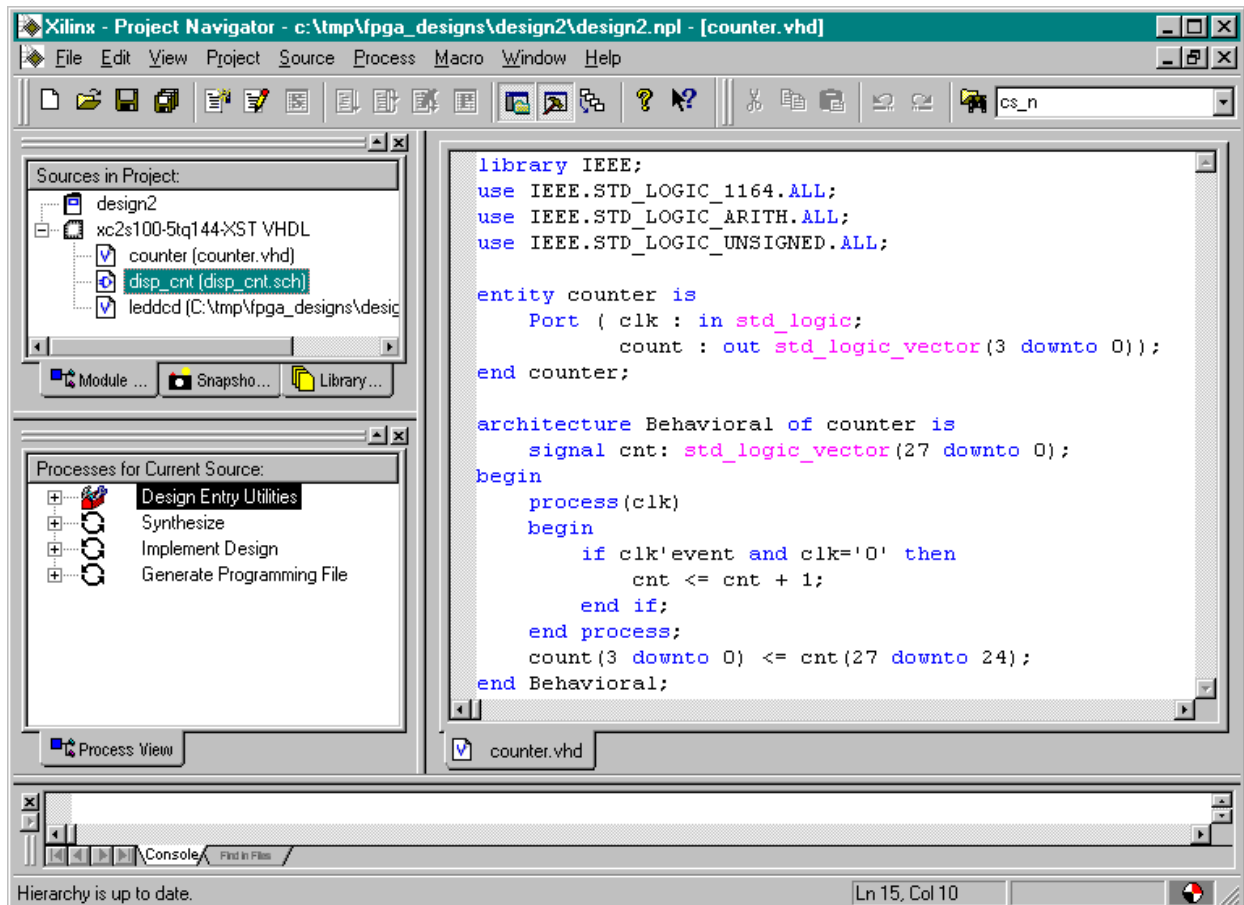

The schematic editor window has a drawing area and a list of categories for various logic circuit elements that can be used in a schematic. Below that is the list of symbols for circuit elements in a highlighted category.

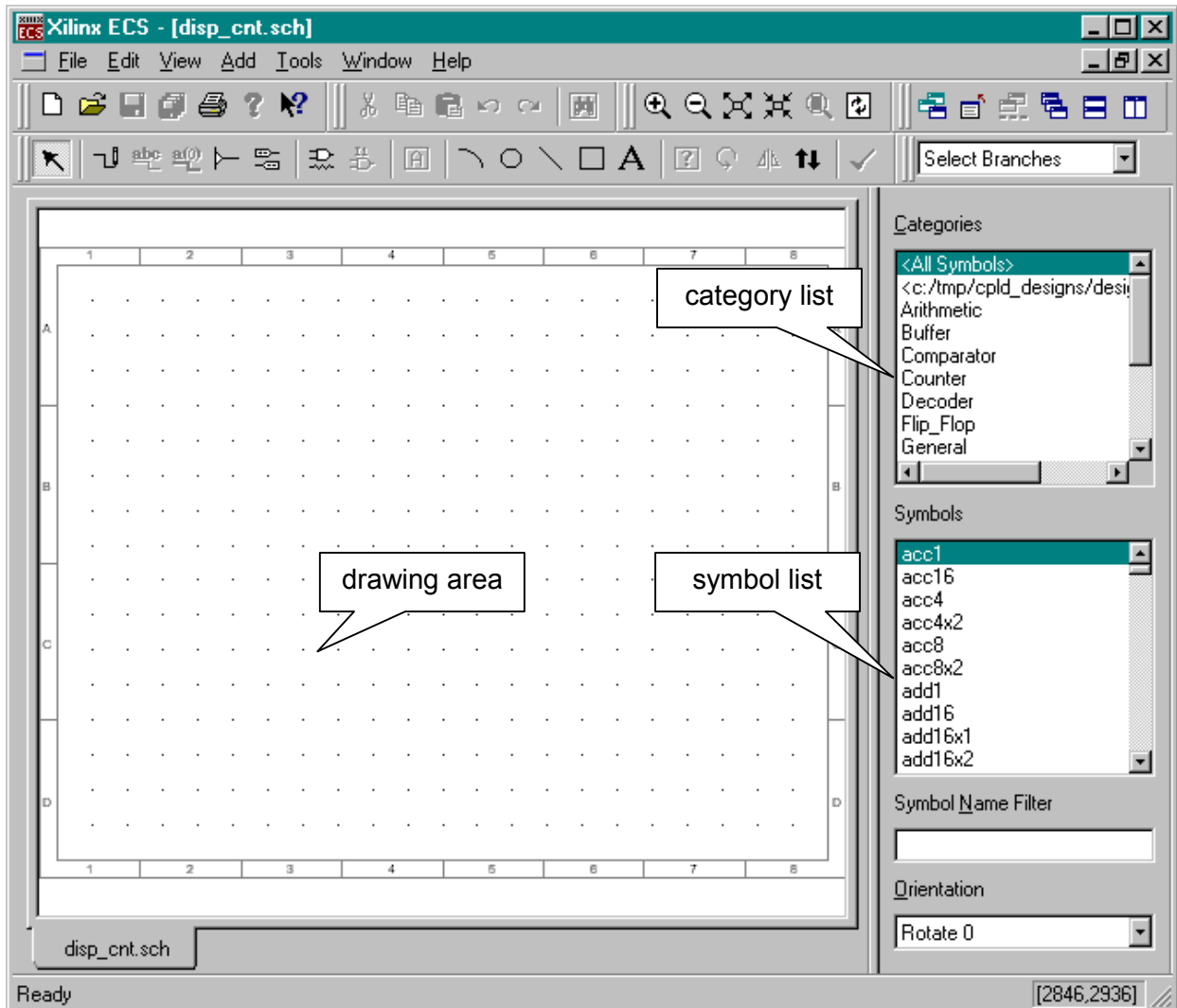

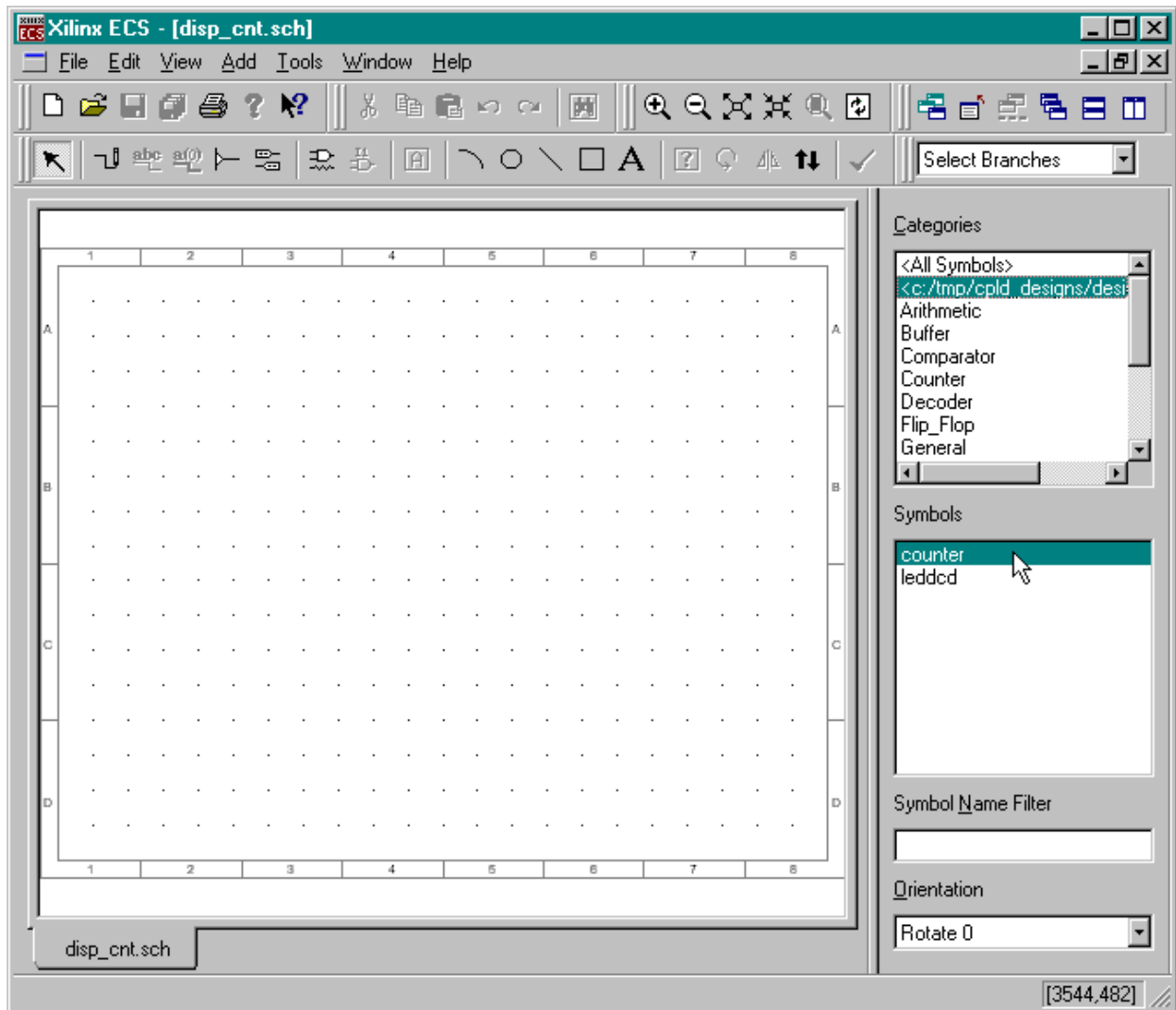

To start creating the top-level schematic, highlight the second entry in the category list. The `c:/tmp/fpga_designs/design2` category contains the schematic symbols for the **design2** project's counter and LED decoder modules. We can see the names of these modules in the symbol list.



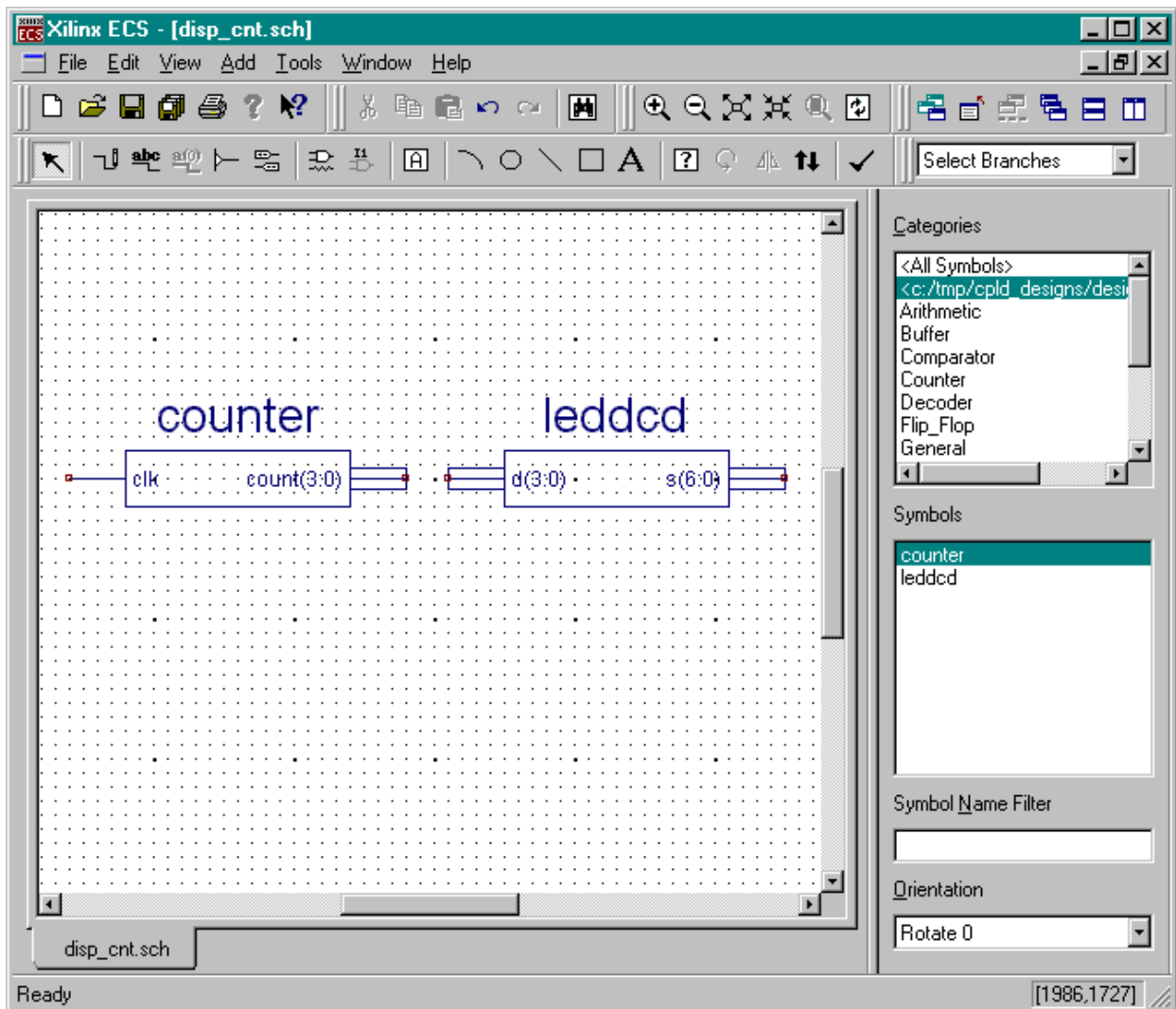

Click on the counter entry in the Symbols list. Then move the mouse cursor into the drawing area and left-click to place an instance of the counter into the schematic. Repeat this process with the leddcd module to arrive at the result shown below.



Next, click on the  button to begin adding wires to the schematic.

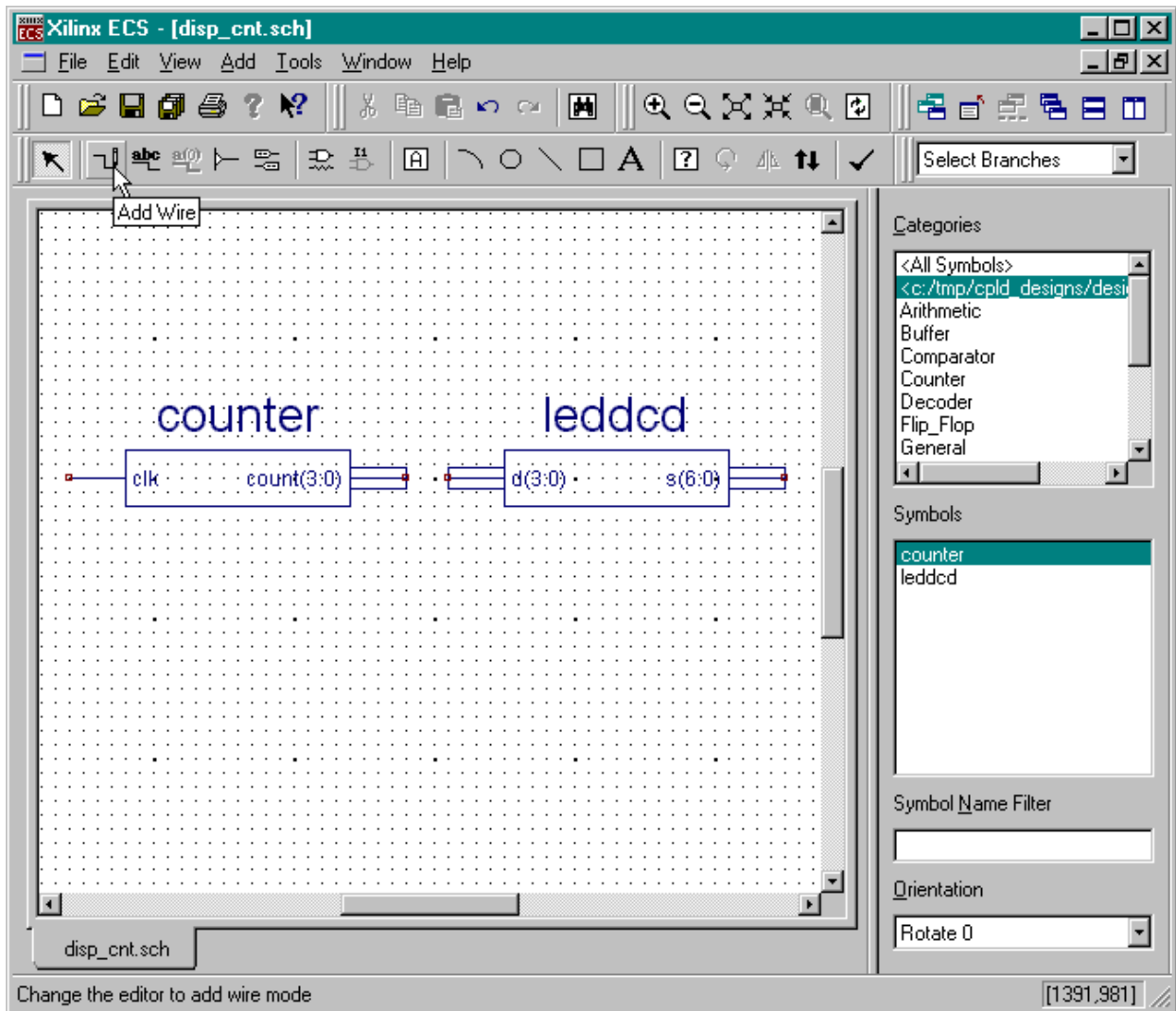

Left-click the mouse on the **count(3:0)** bus on the right-hand edge of the **counter** module. Then left-click on the **d(3:0)** bus on the left-hand edge of the **leddcd** module. As a result of this procedure, a four-bit bus is created between the output of the counter module and the input of the LED decoder module. Either click in the same endpoint or hit the ESC key to stop adding segments to the bus.

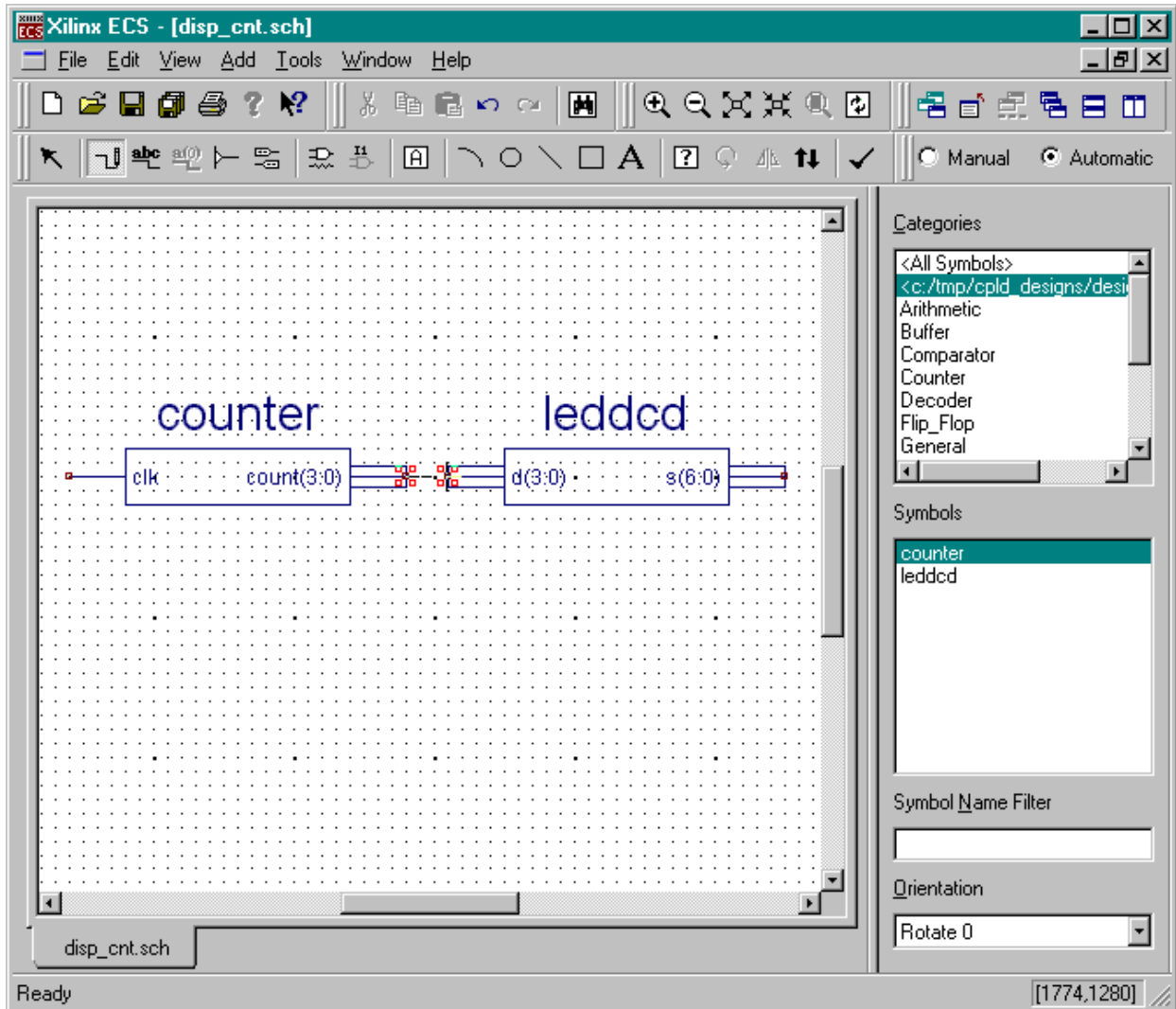

Now highlight the IO category and select a byte-wide output buffer (OBUF8) from the list of symbols. Attach the output buffer to the output of the LED decoder as shown below.

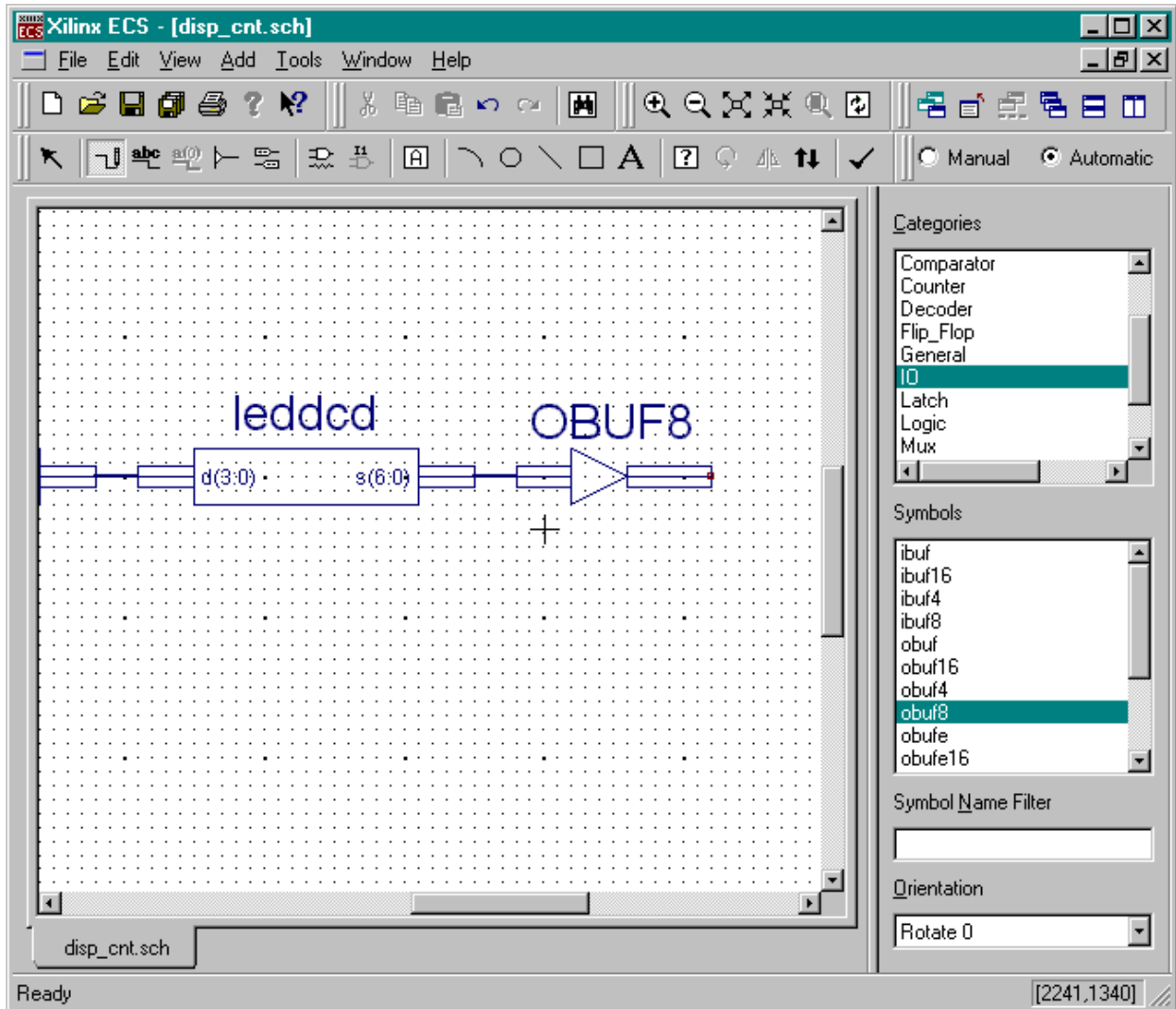

Next attach a short bus segment to the output of the byte-wide buffer.

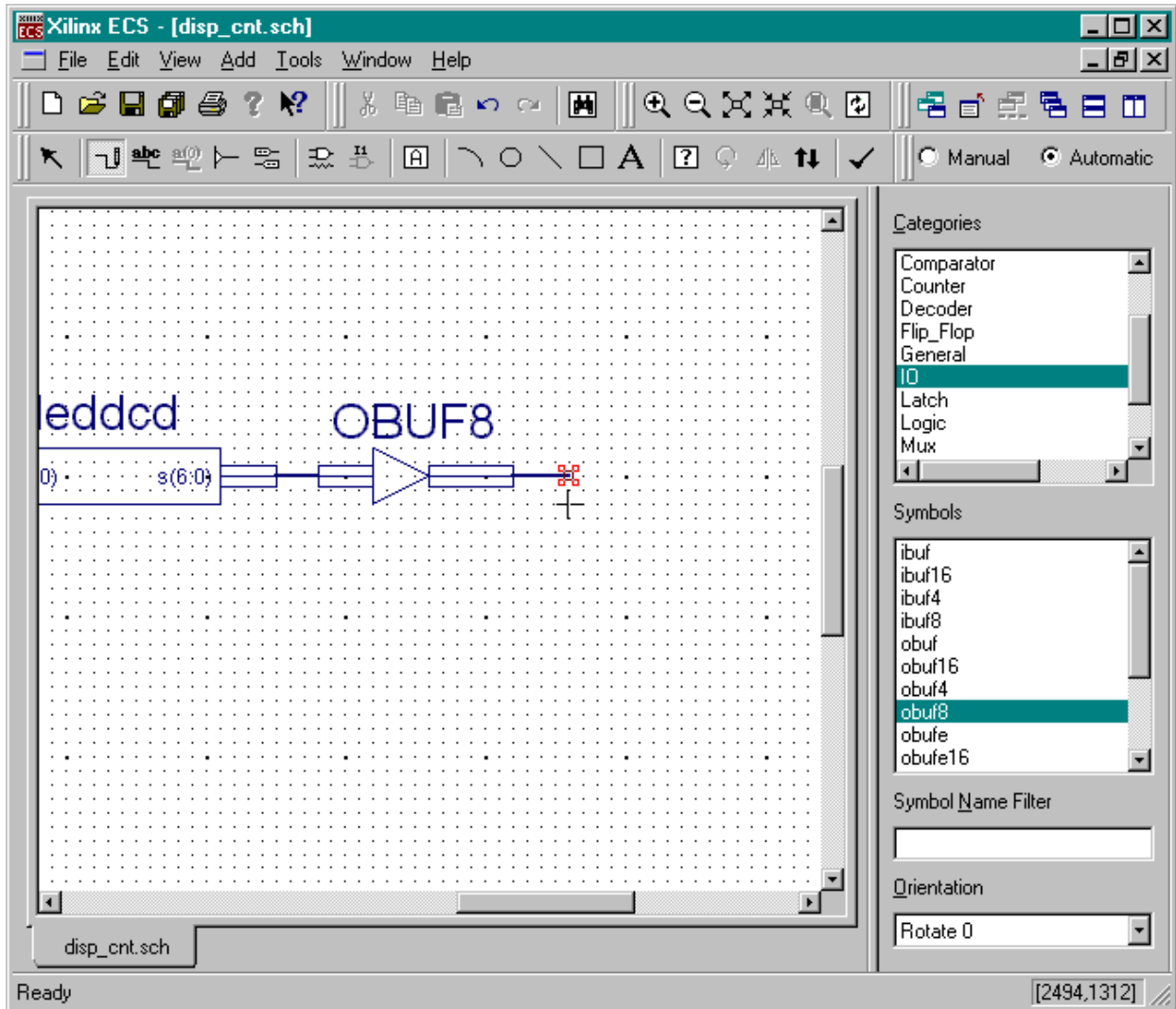

Now click on the  button for adding I/O markers.

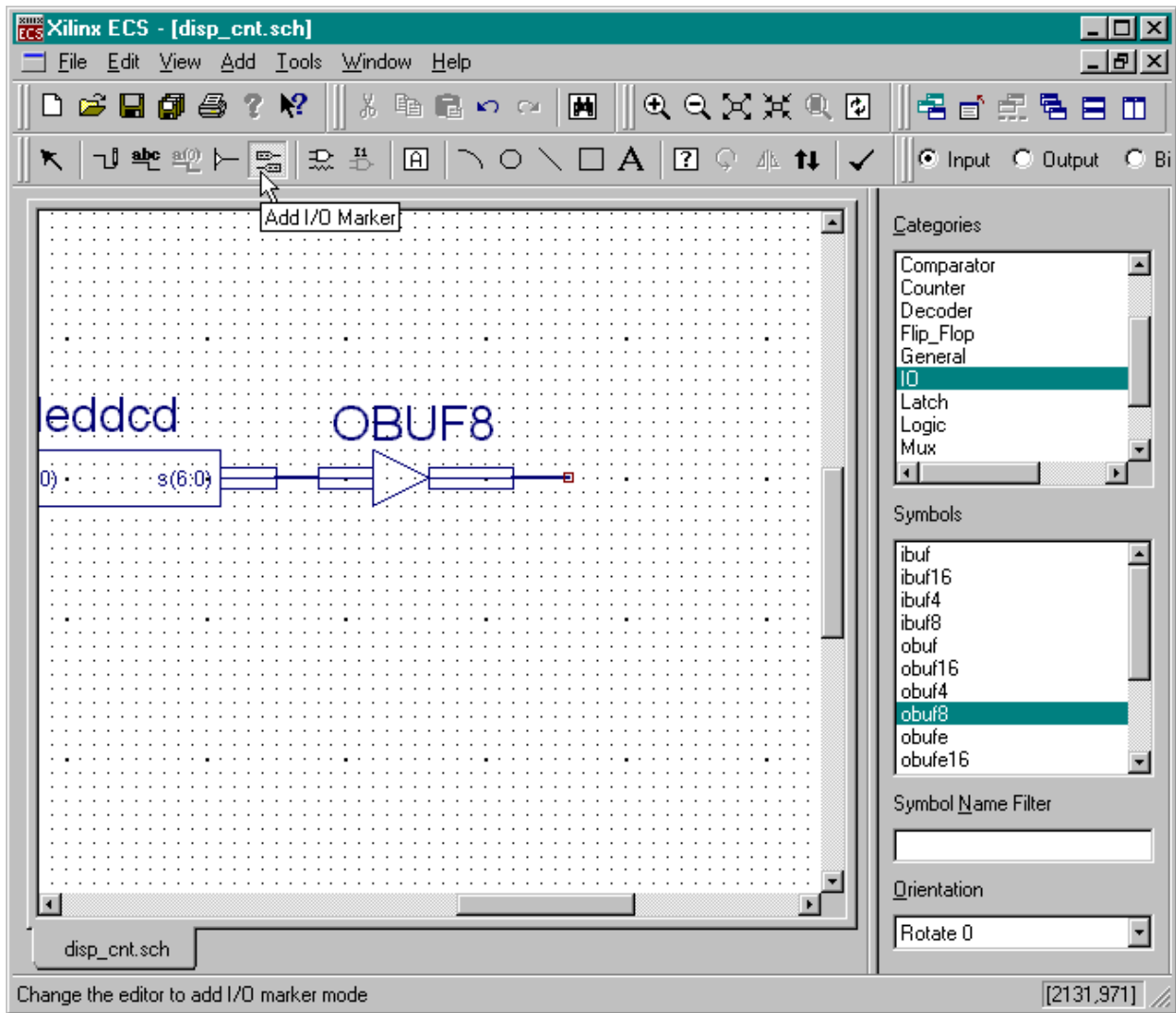

Then click on the other end of the newly-added bus segment to create a byte-wide set of output pins.

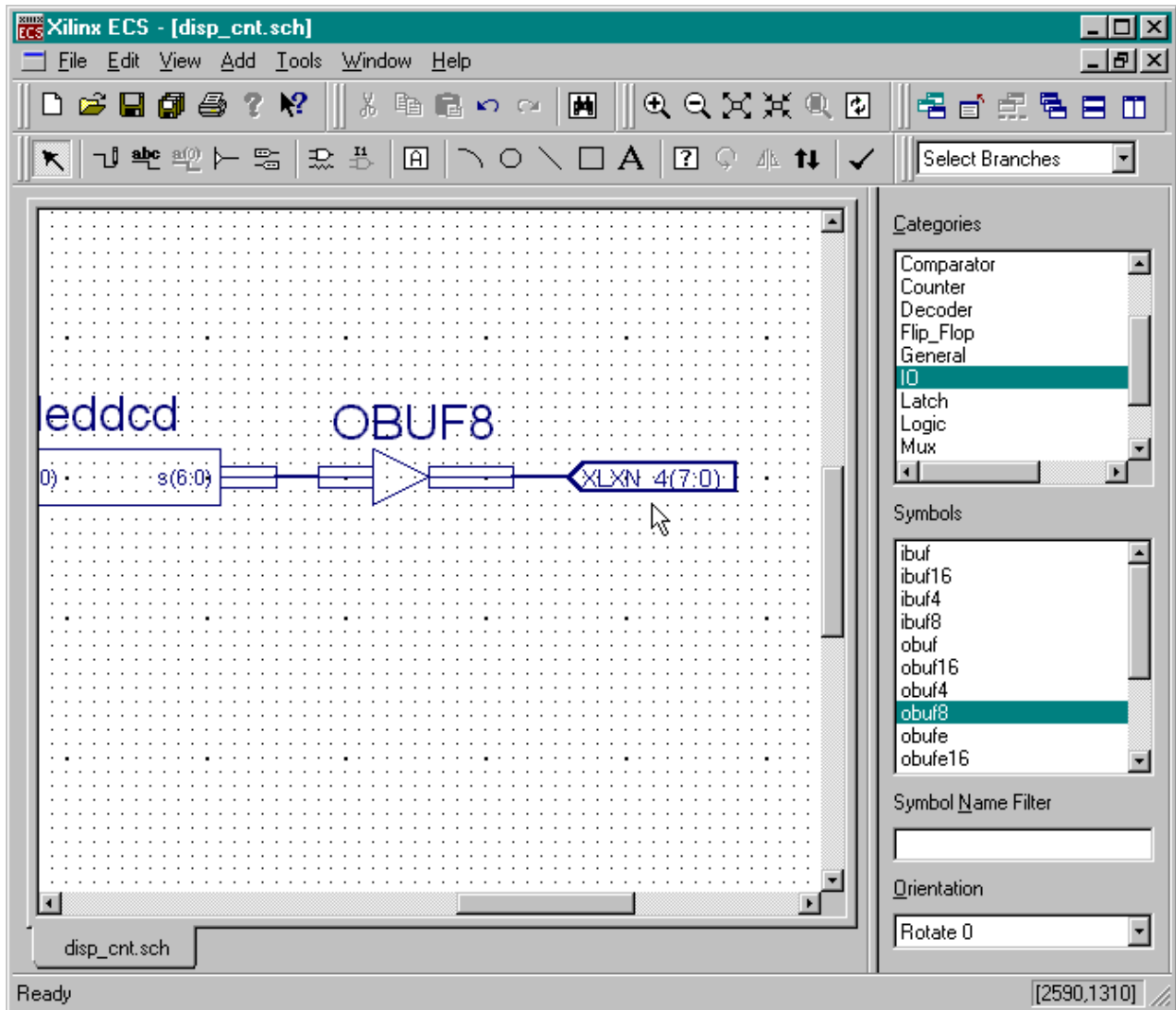

The output pins automatically assume the same name as the bus to which they are attached but this name was automatically generated and doesn't carry a lot of meaning. To change the name of the outputs (and the associated bus), right-click on the I/O marker and select Object Properties... from the pop-up menu.

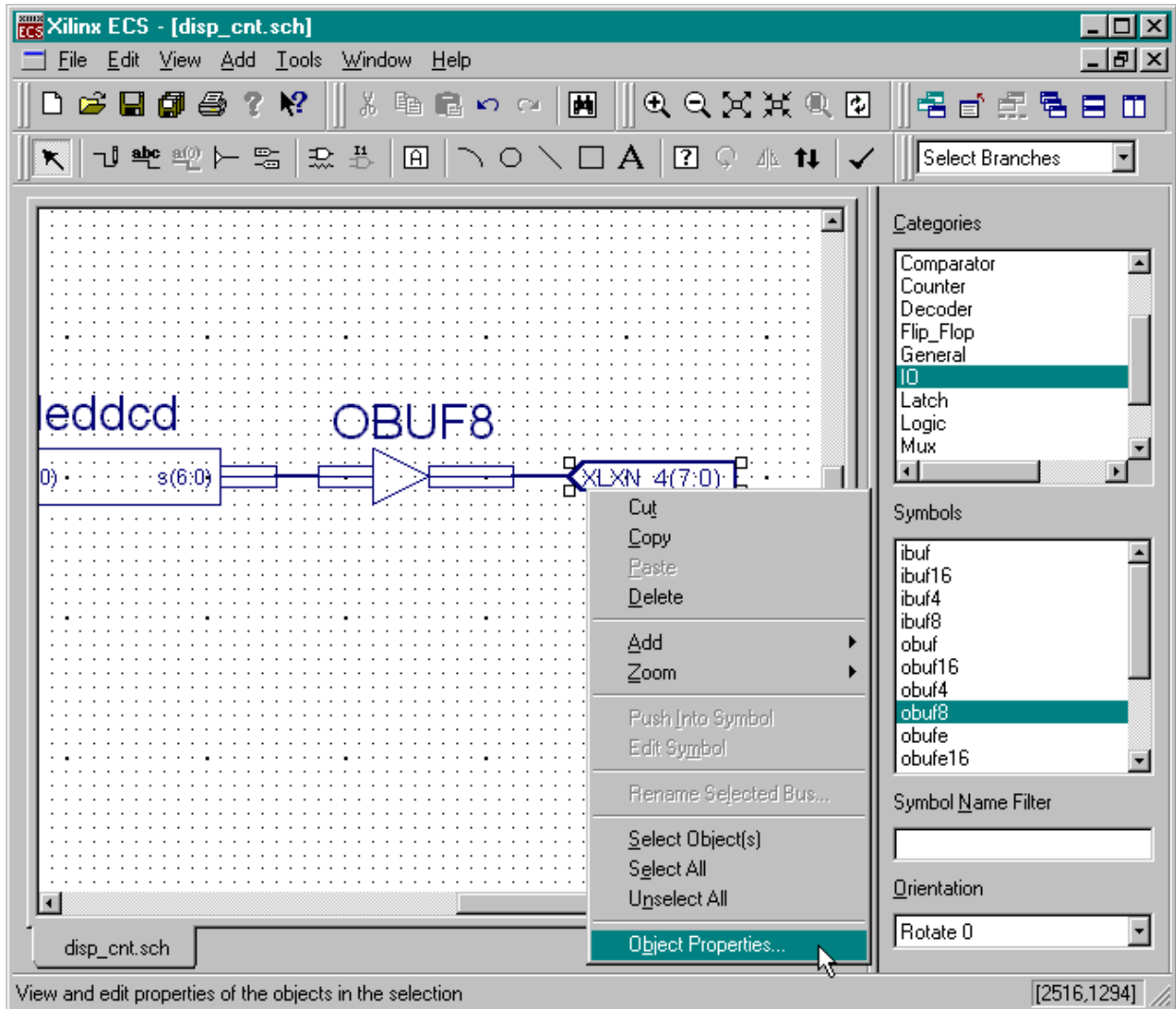



The **Object Properties** window allows us to set the name and direction of the pins.

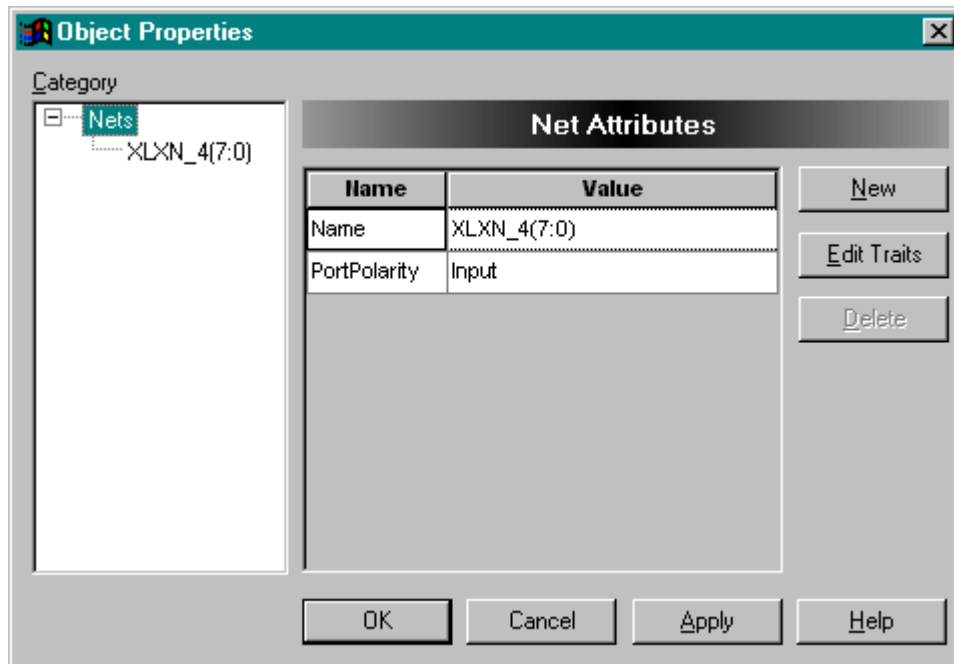

Replace the existing bus name with a seven-bit bus for driving the LED segments: **S(6:0)**. Then set the direction of the bus pins to Output.

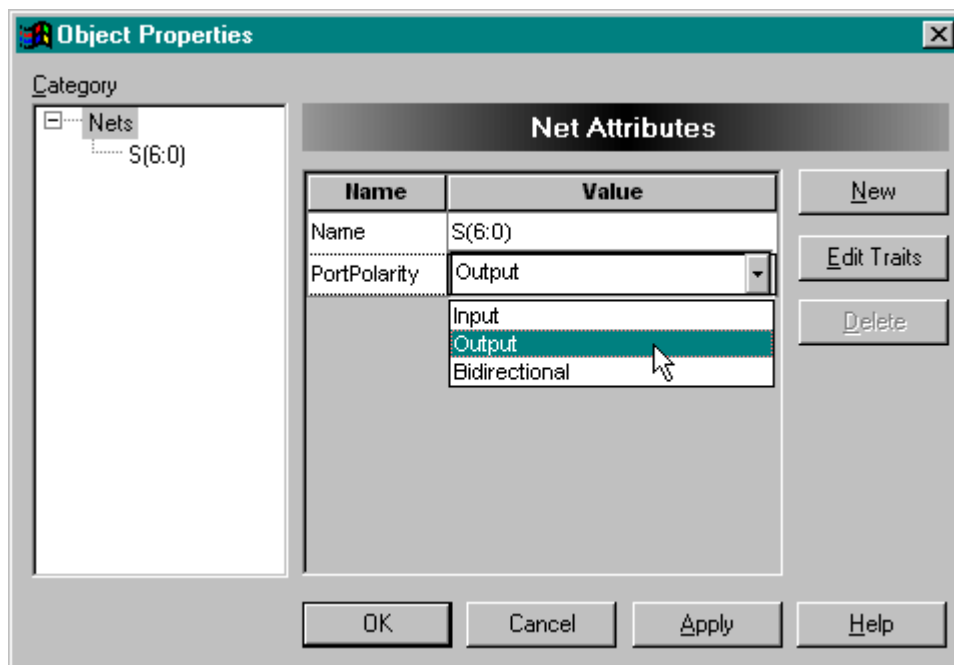

Next click on the OK button to close the **Object Properties** window.

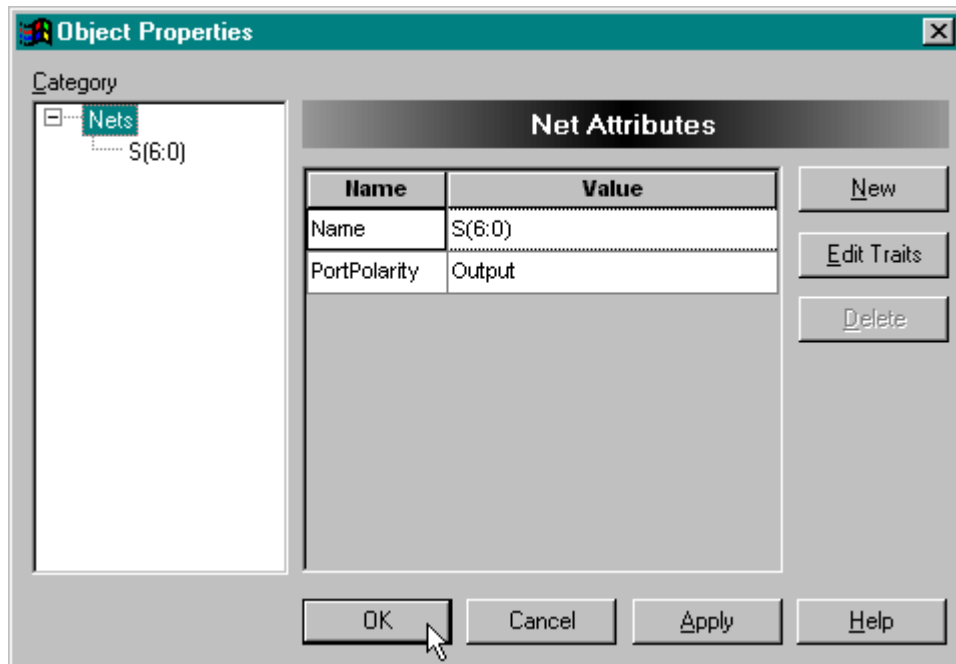

The output pins now appear with their new name, width, and direction.

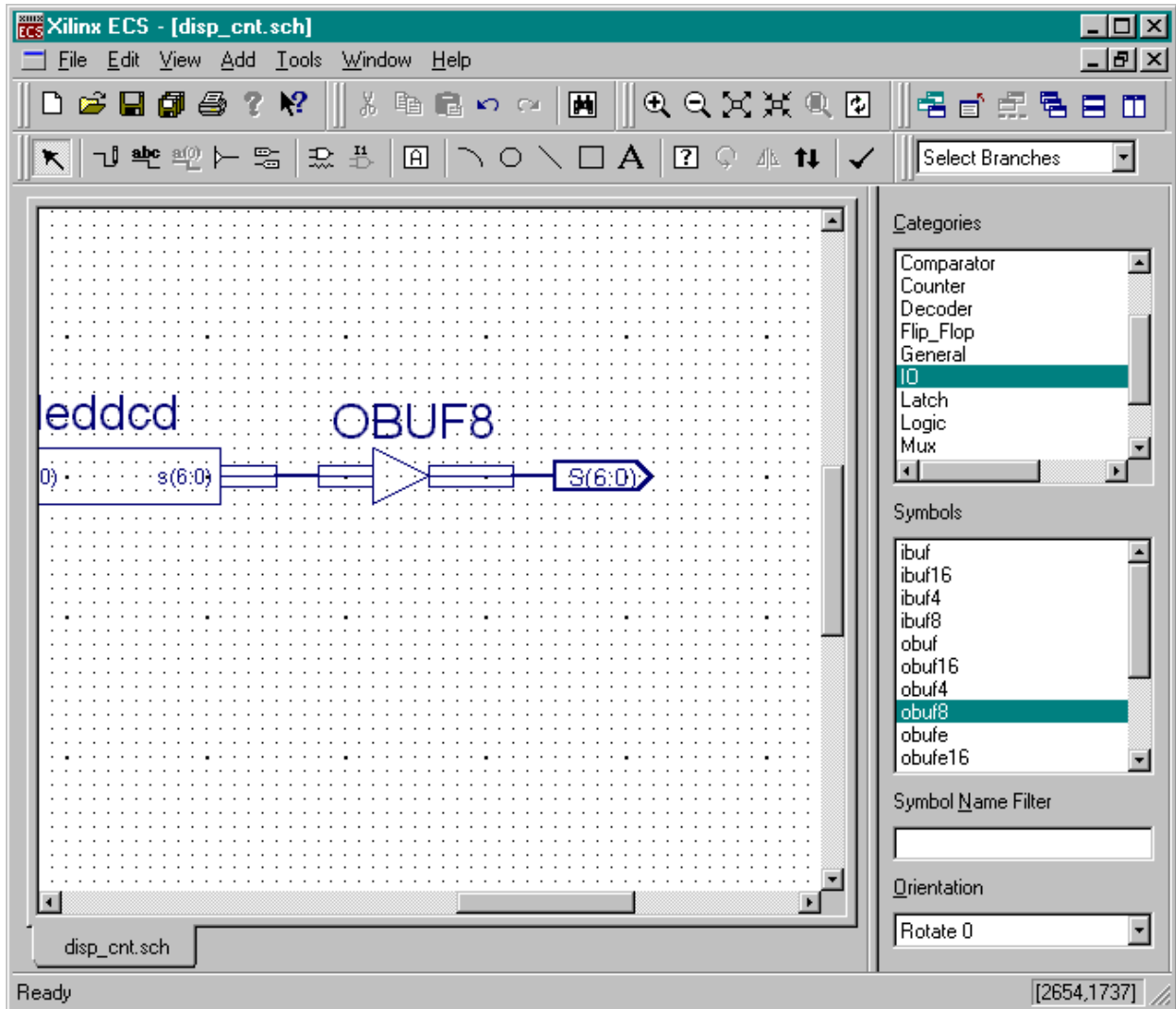

At this point it makes sense to check the schematic to see if there are any errors such as unterminated wire stubs or mismatched bus widths. Click on the  button to perform a schematic check.

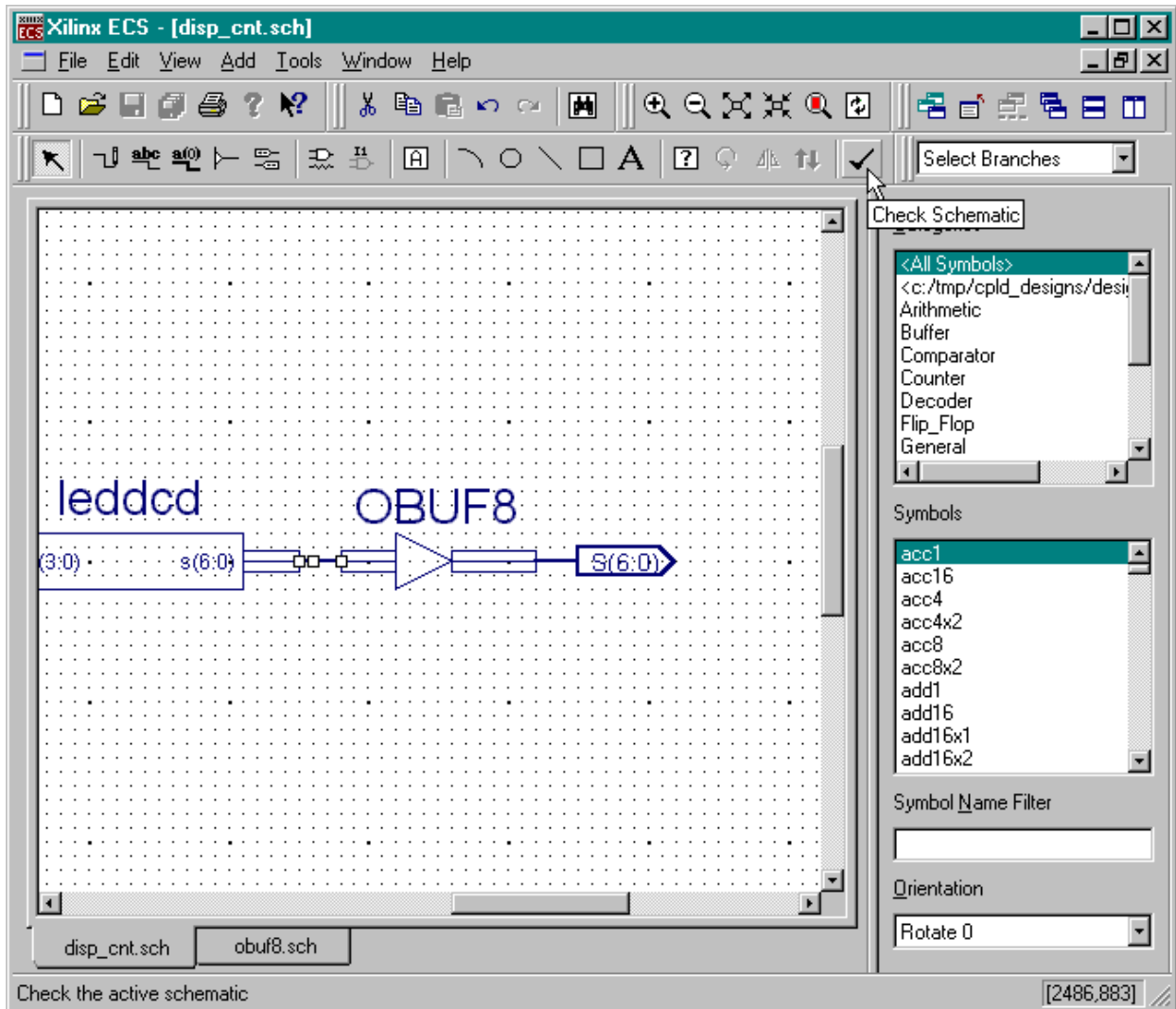

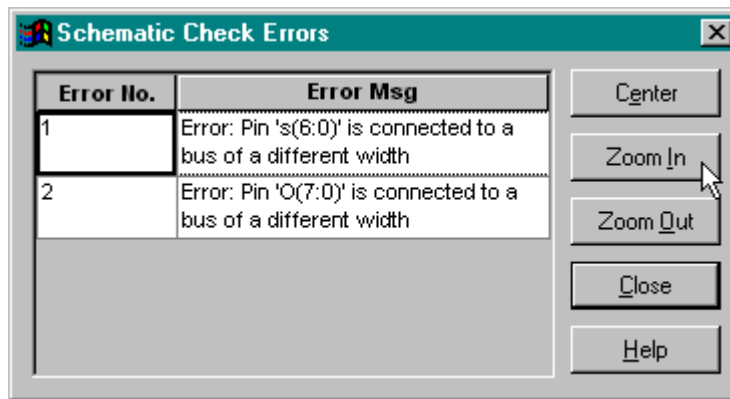

The **Schematic Check Errors** window will appear showing two errors. We can find the place in the schematic where the error occurs by clicking on the associated error message. Then clicking on the Zoom In button to see an enlarged view of the area where the error lies.

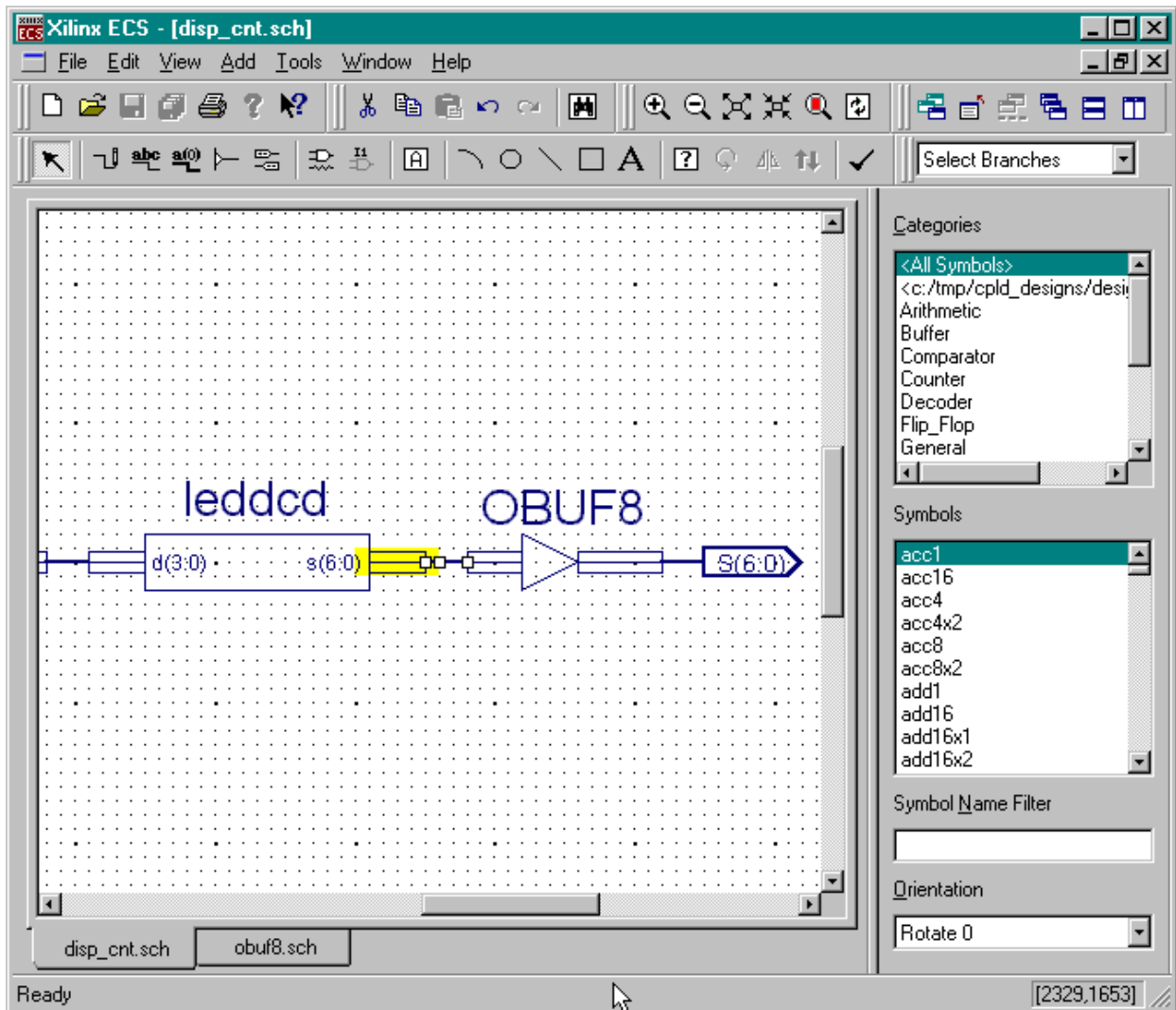

The first error indicates that the seven-bit output of the LED decoder does not match with the byte-wide input of the output buffer symbol. Note how the output of the leddcd symbol is highlighted to indicate the error. The second error is similar to the first in that the byte-wide output of the OBUF8 symbol does not match the width of the seven-bit output pin marker.



We could try solve these problems by using subsets of the buses or by adjusting the width of the output buffers. But the simplest solution is to remove the byte-wide output buffer and replace it with a group of seven output buffers. To start this process, click on the  button and then click on the OBUF8 symbol. Then press the delete key. Then click on the  button and add bus segments to the schematic as shown below.

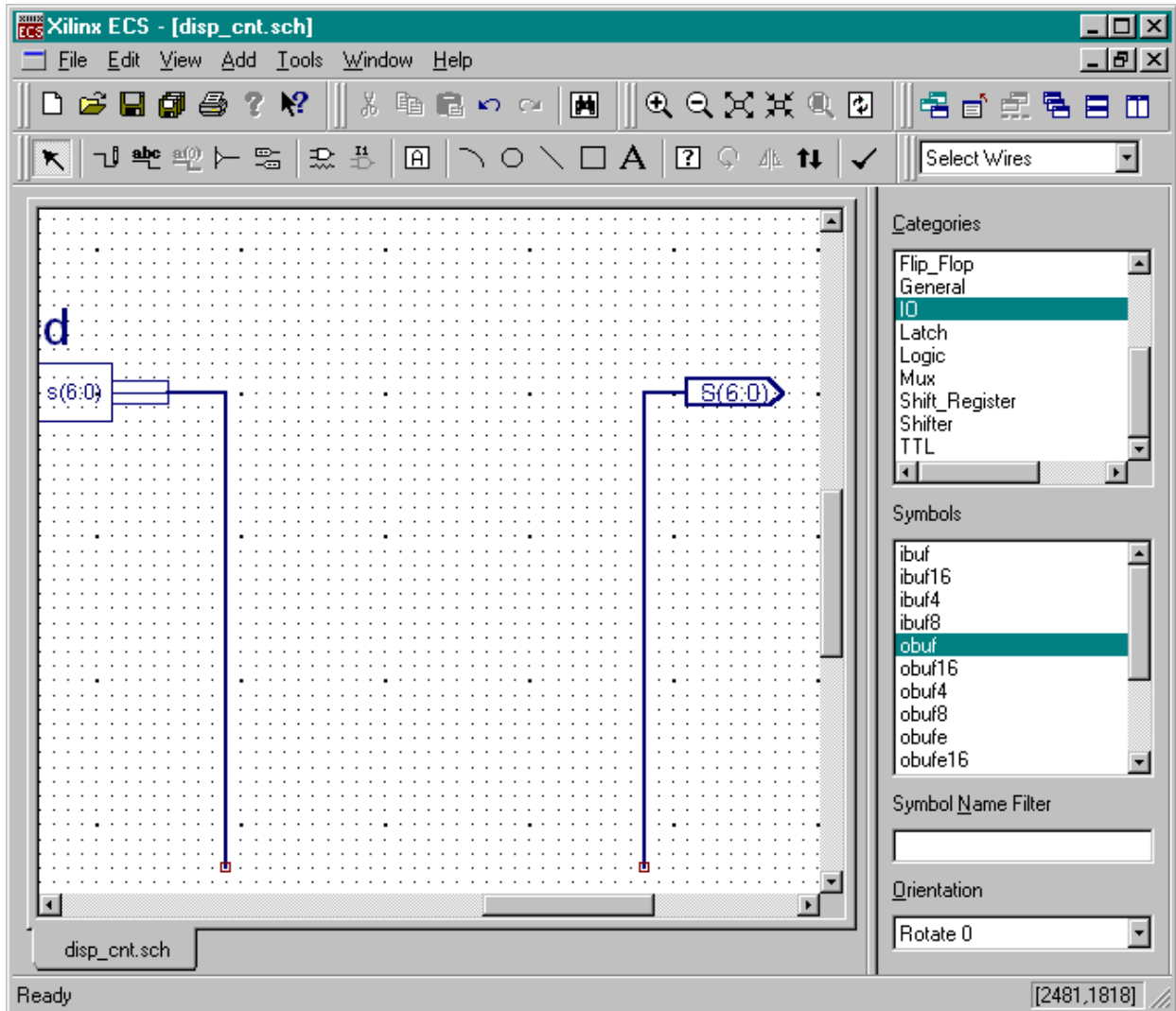

At this point it is a good idea to rename the bus connected to the LED decoder output so it has a less cumbersome name. Double-click on the bus and the **Object Properties** window will appear.

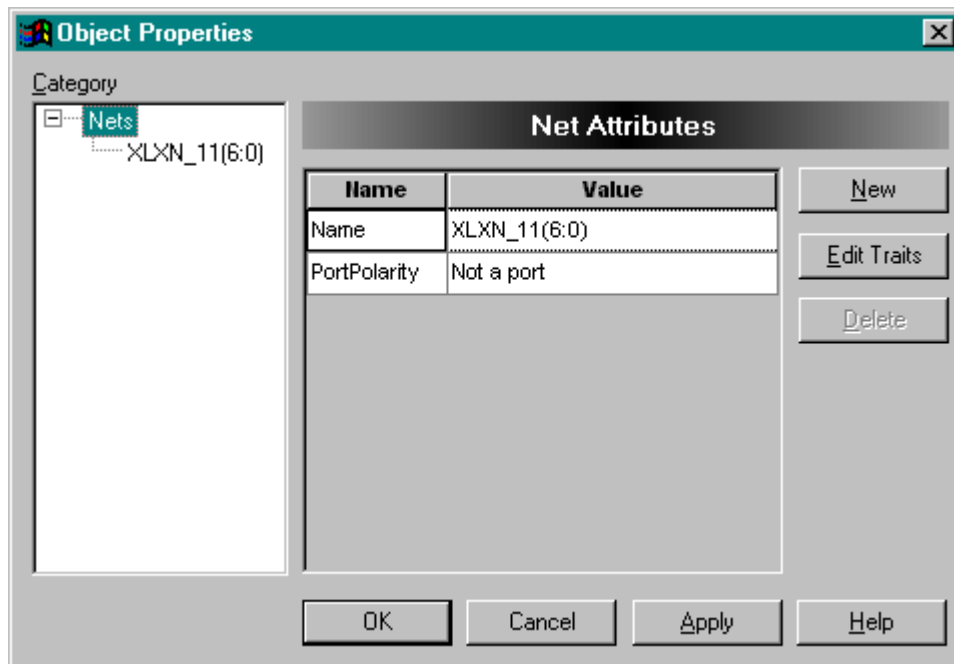

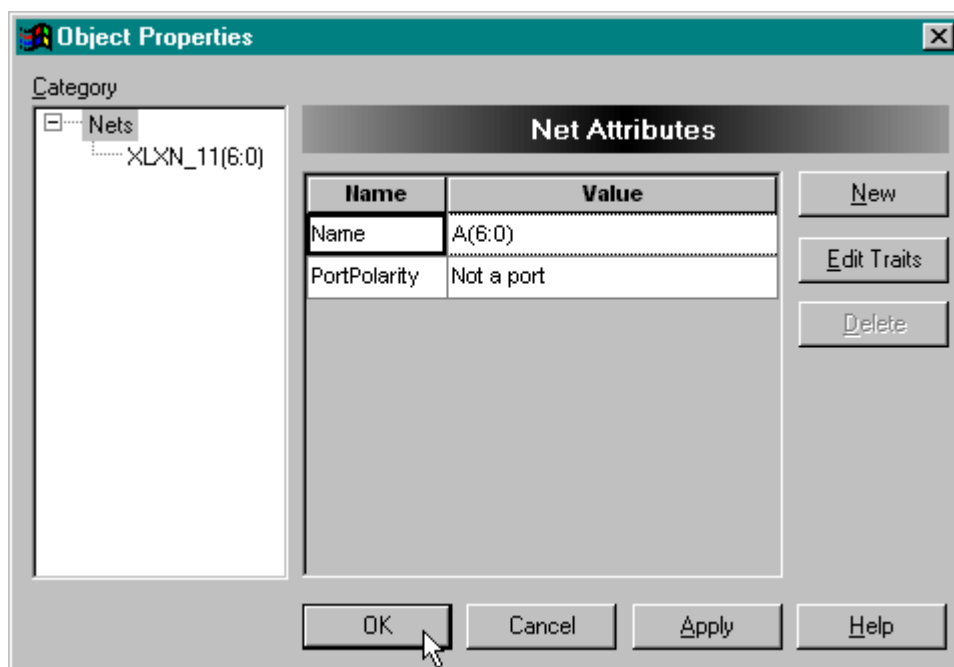

Replace the automatically-assigned name for the seven-bit bus, **XLXN\_11(6:0)**, with the bus name **A(6:0)**. Then click on the OK button.



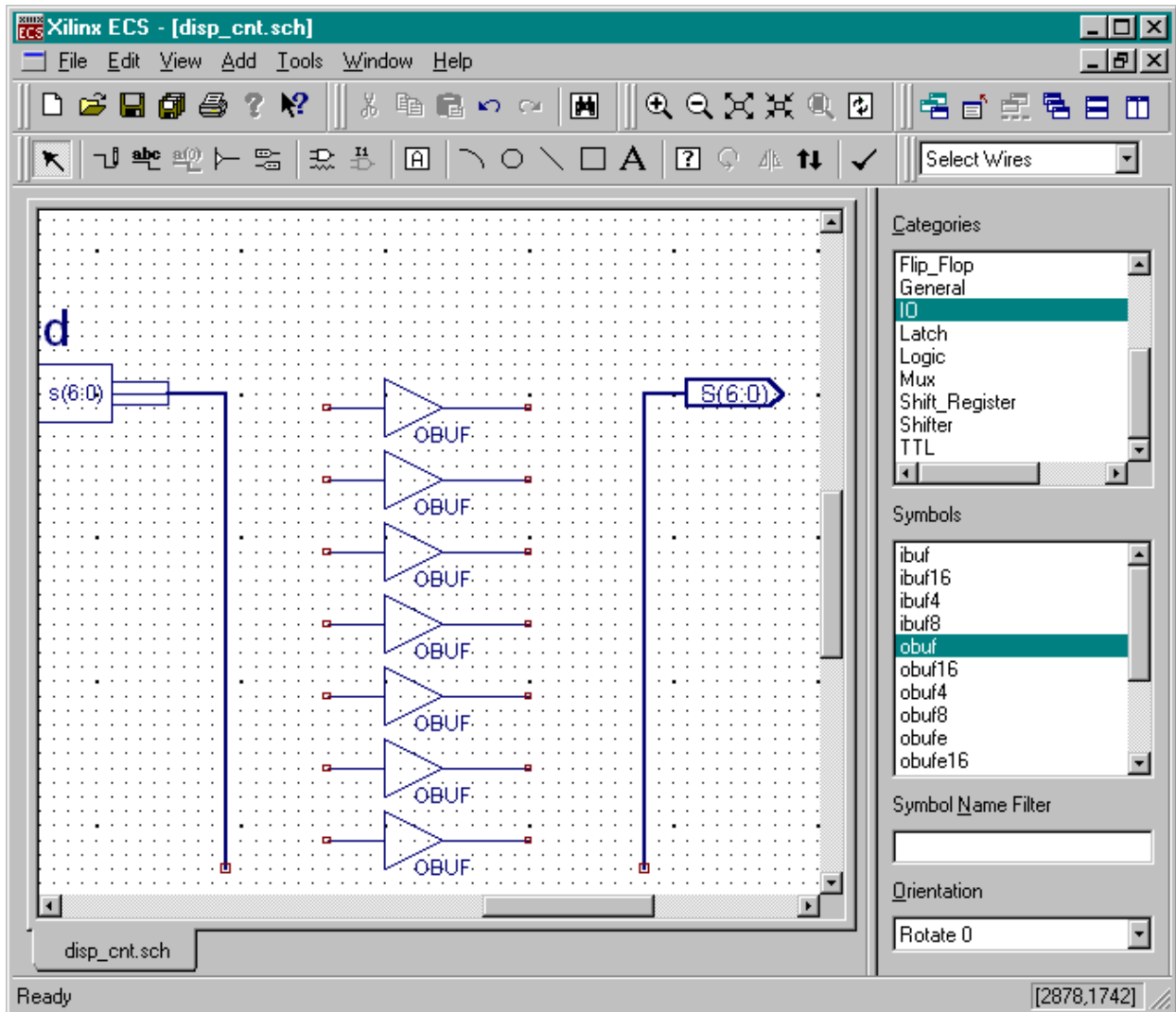

Next select a single-bit output buffer, obuf, from the list of symbols and drop seven of them into the schematic drawing area.



Now the output buffers have to be attached to the buses. Click on the  button and attach seven bus taps to each bus as shown below. (Use the rotation button to rotate the bus tap symbol.)

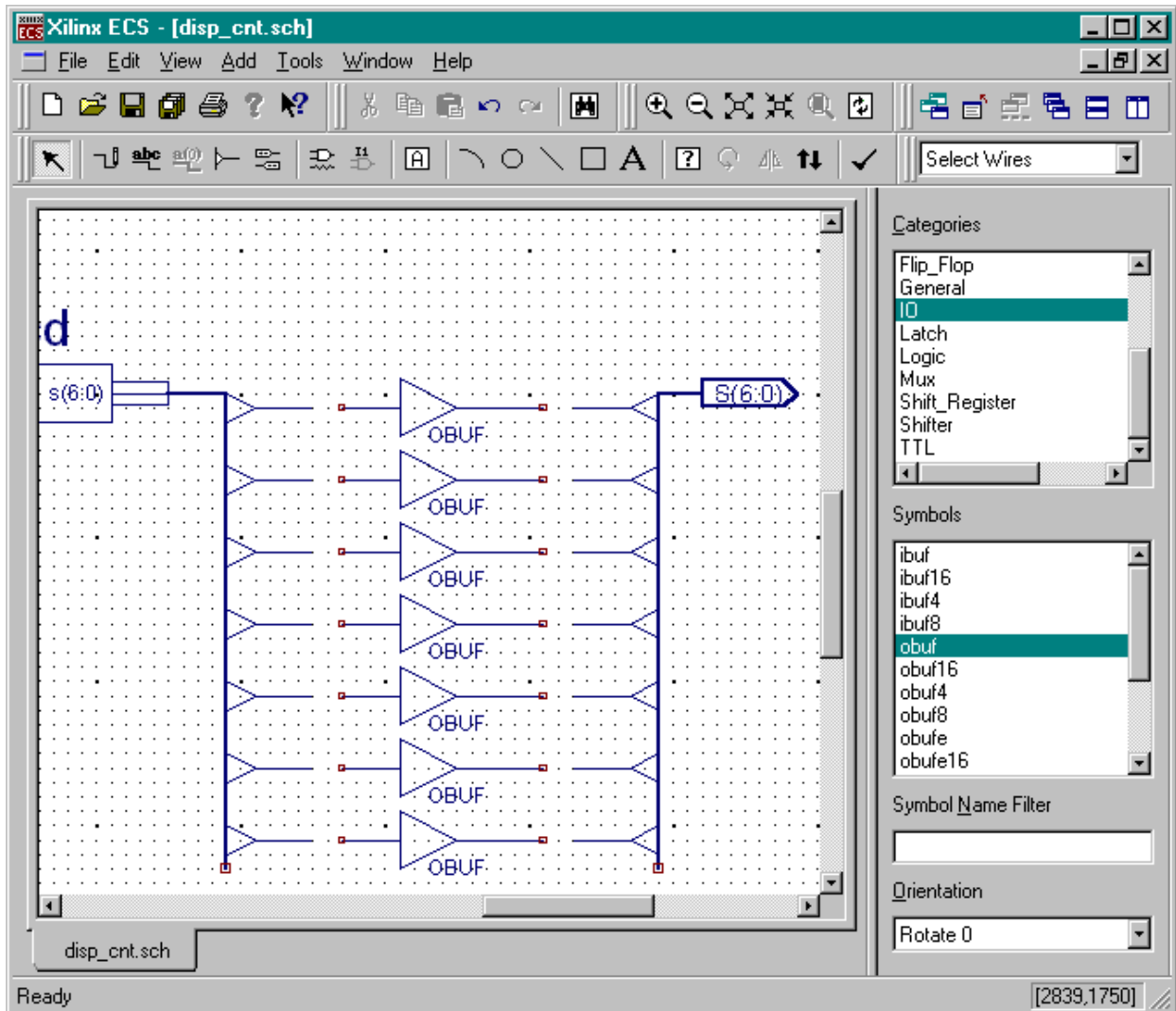

Once all the bus taps are in place, attach the output buffers to the taps using wire segments.

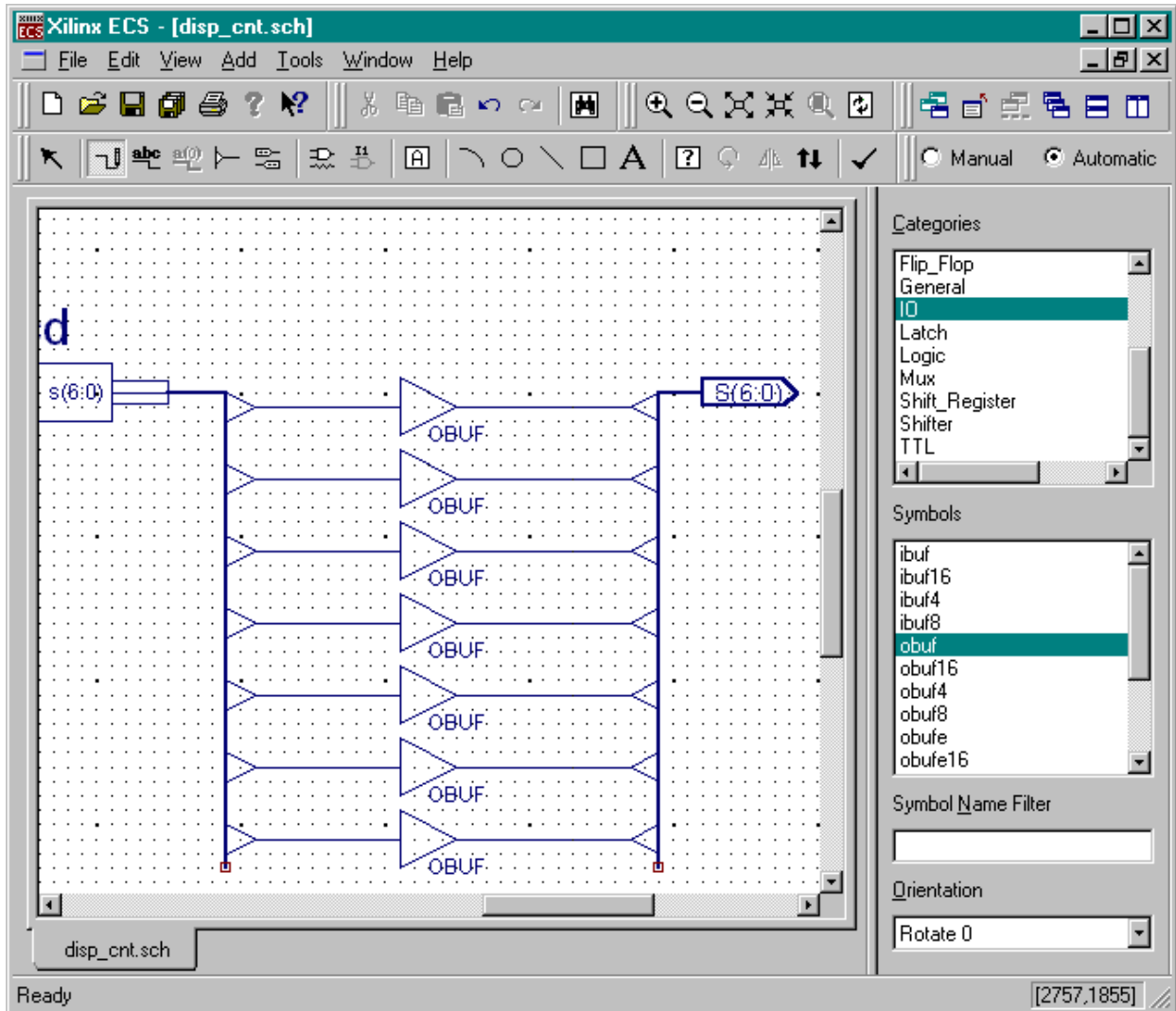

Now the question becomes: “How do we know each output buffer is attached to the right LED decoder output and output pin?” The answer is: “We don’t!” We have to manually set the connections to the buses to make sure they are correct. Double-click on the wire segment connecting the output buffer to the S(6:0) output bus. (Make sure you double-click the wire segment and not the bus tap symbol or the OBUF symbol.) The **Object Properties** window will appear with the name for the wire segment that was automatically assigned by the schematic editor.

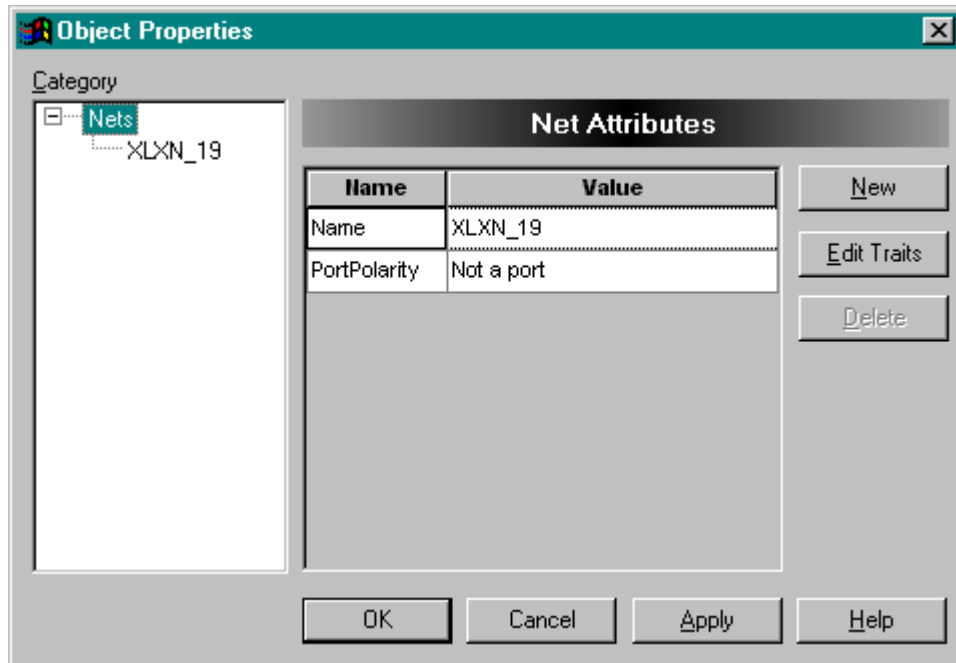

Change the name of the wire segment to S(0) which is the least-significant bit of the output bus. Then click on OK.

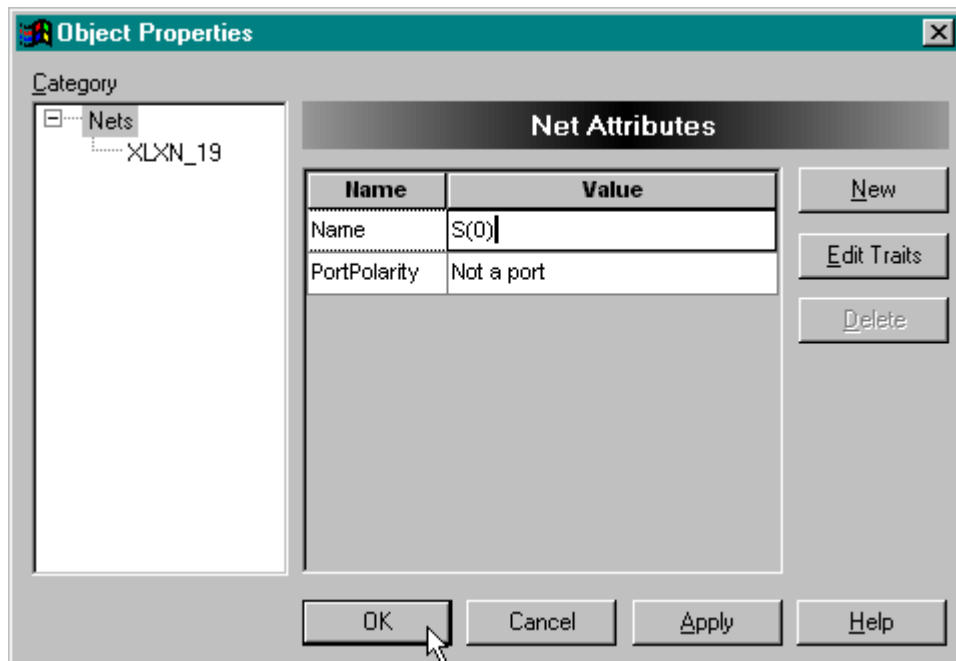

Repeat the process to rename each wire segment as shown below. (The visible labels for each wire segment were added afterward. The wire segment labels will not be shown by the schematic editor.)

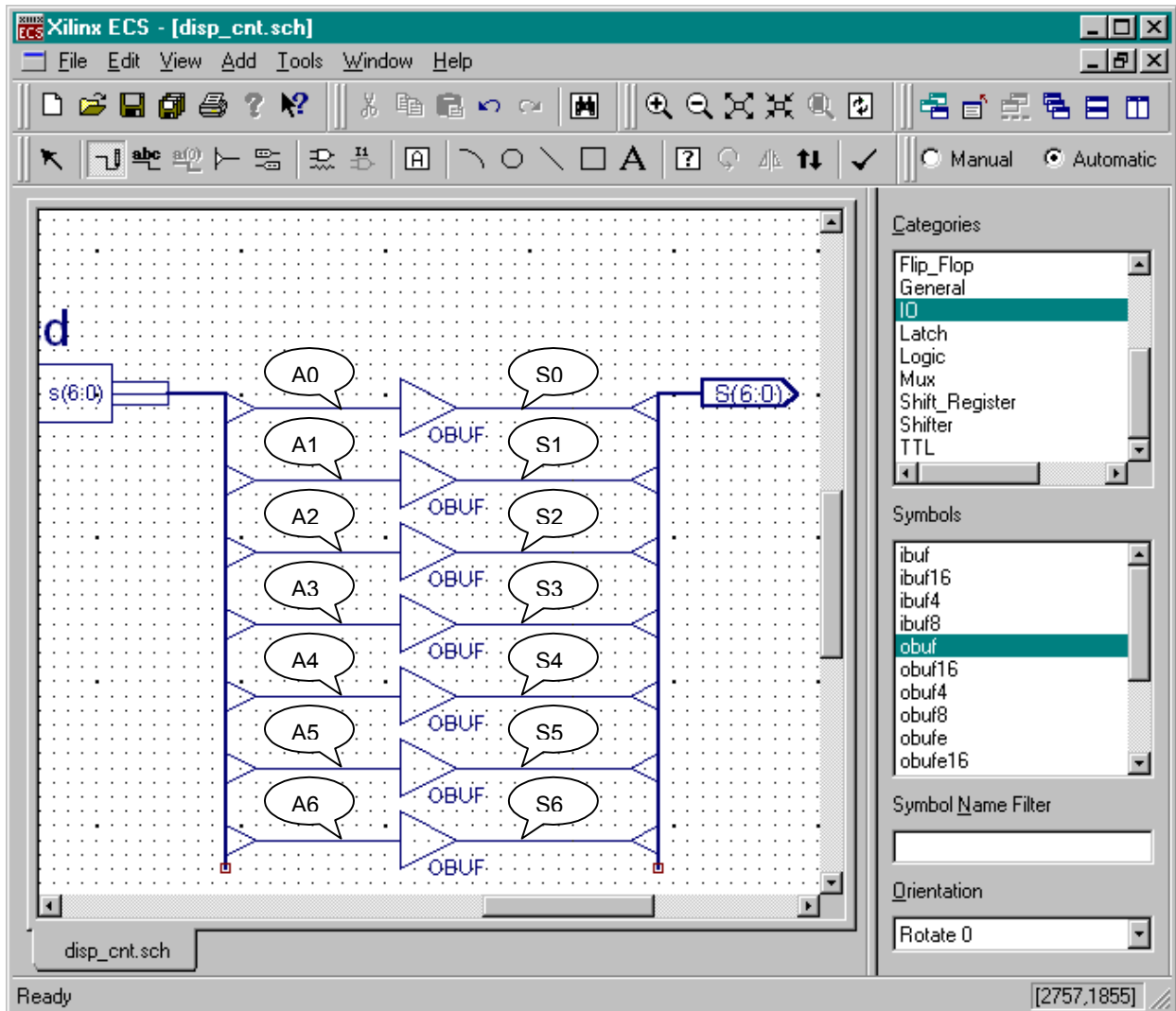

Now when we click on the schematic check button, , we see the errors have been corrected.

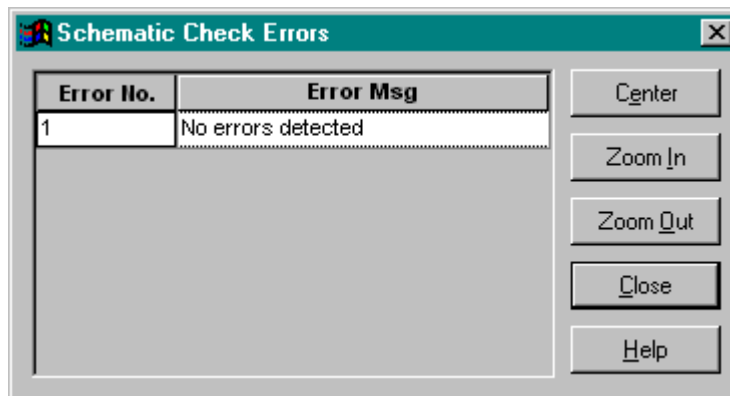

Once the outputs from the circuit are in place, we can create the analogous circuitry for the input. We connect a single, low-skew input buffer module to the clock input of the counter and then we connect a single input I/O marker to the IBUFG symbol. After this, perform another schematic check to detect any errors, save the schematic using the File→Save command and then close the schematic editor.

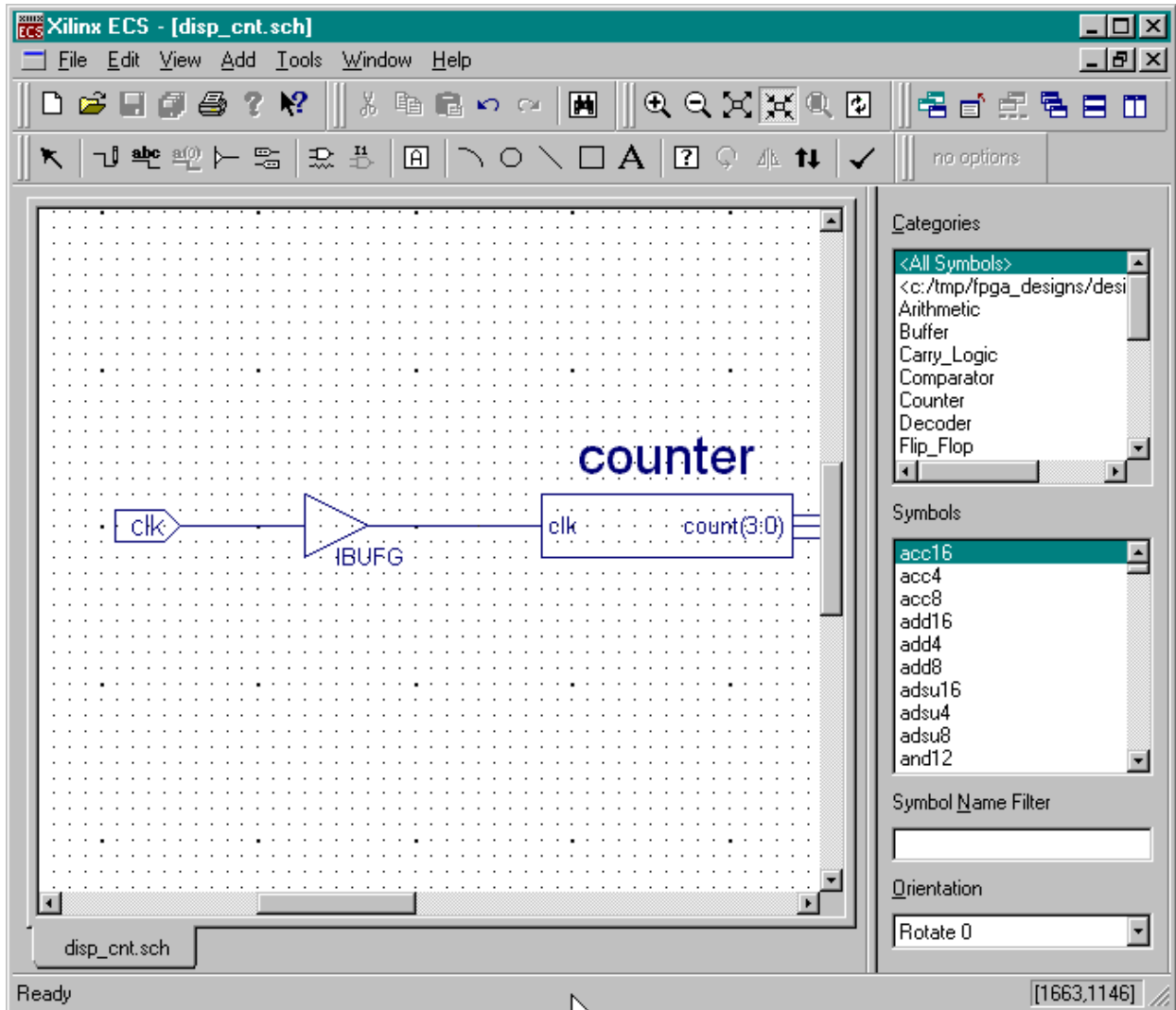

Once we save the schematic for the top-level module, we see the updated hierarchy in the Sources pane of the **Project Navigator** window. Now the **counter** and **leddcd** modules are shown as lower-level modules that are included within the top-level **disp\_cnt** module.

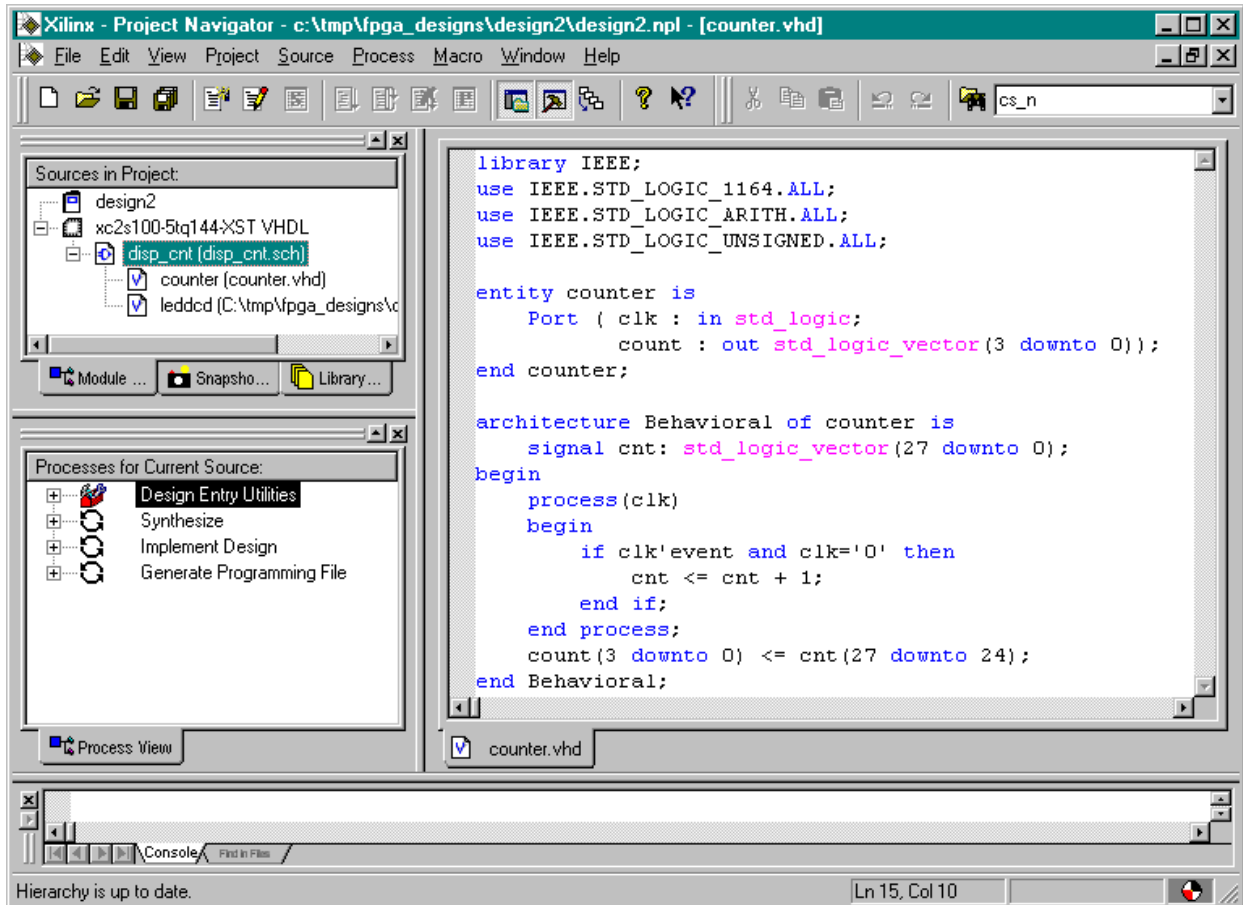



## Checking the VHDL Syntax

We can check the entire design by highlighting the disp\_cnt object in the Sources pane and then double-clicking the Analyze Hierarchy process. This checks the VHDL for each module and their interconnections with each other. The  that appears after the Analyze Hierarchy process completes shows we have no syntax problems in our modules.

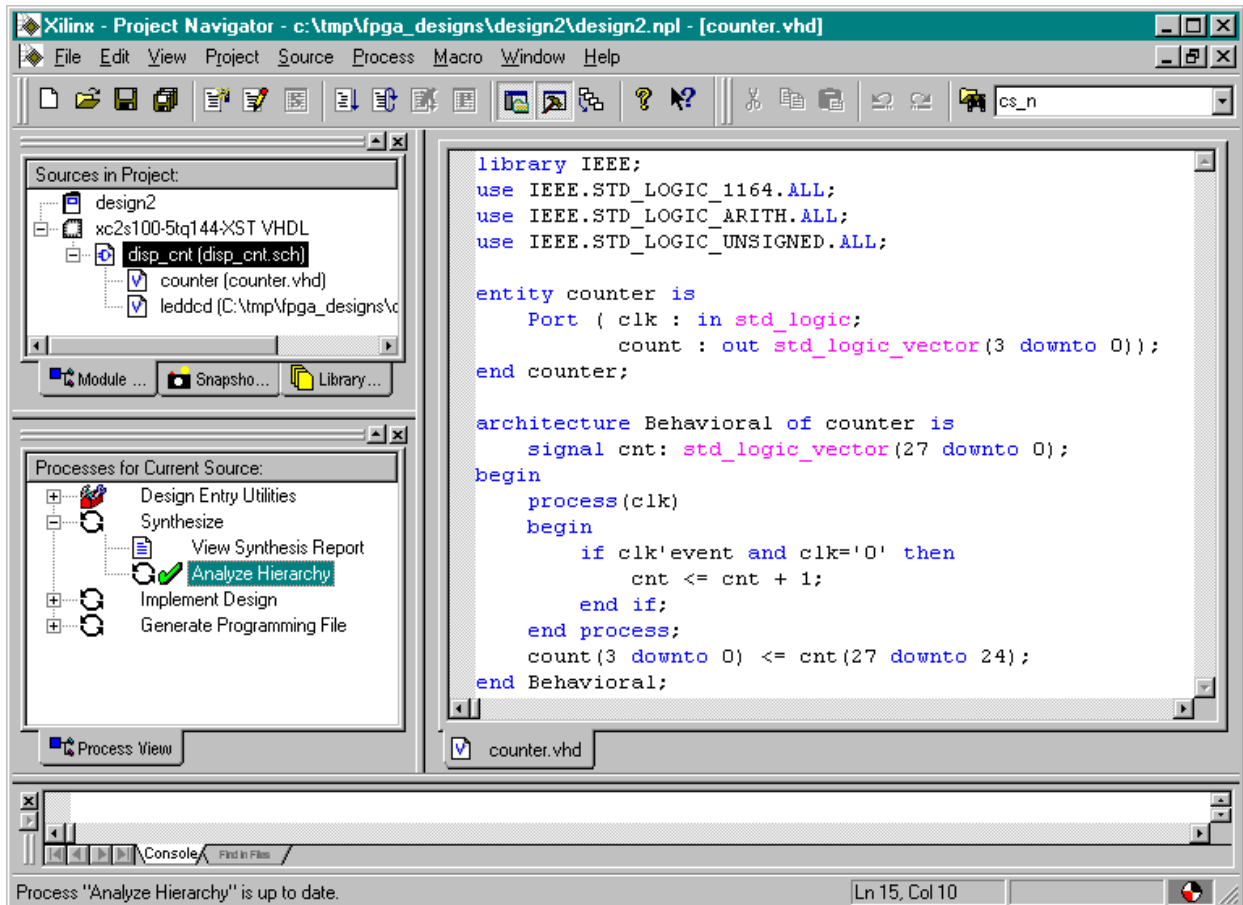

## Constraining the Design

Before synthesizing the displayable counter, we need to assign the pins which the inputs and outputs will use. Highlight the `disp_cnt` object in the Sources pane and then double-click the Edit Implementation Constraints (Constraints Editor) process.

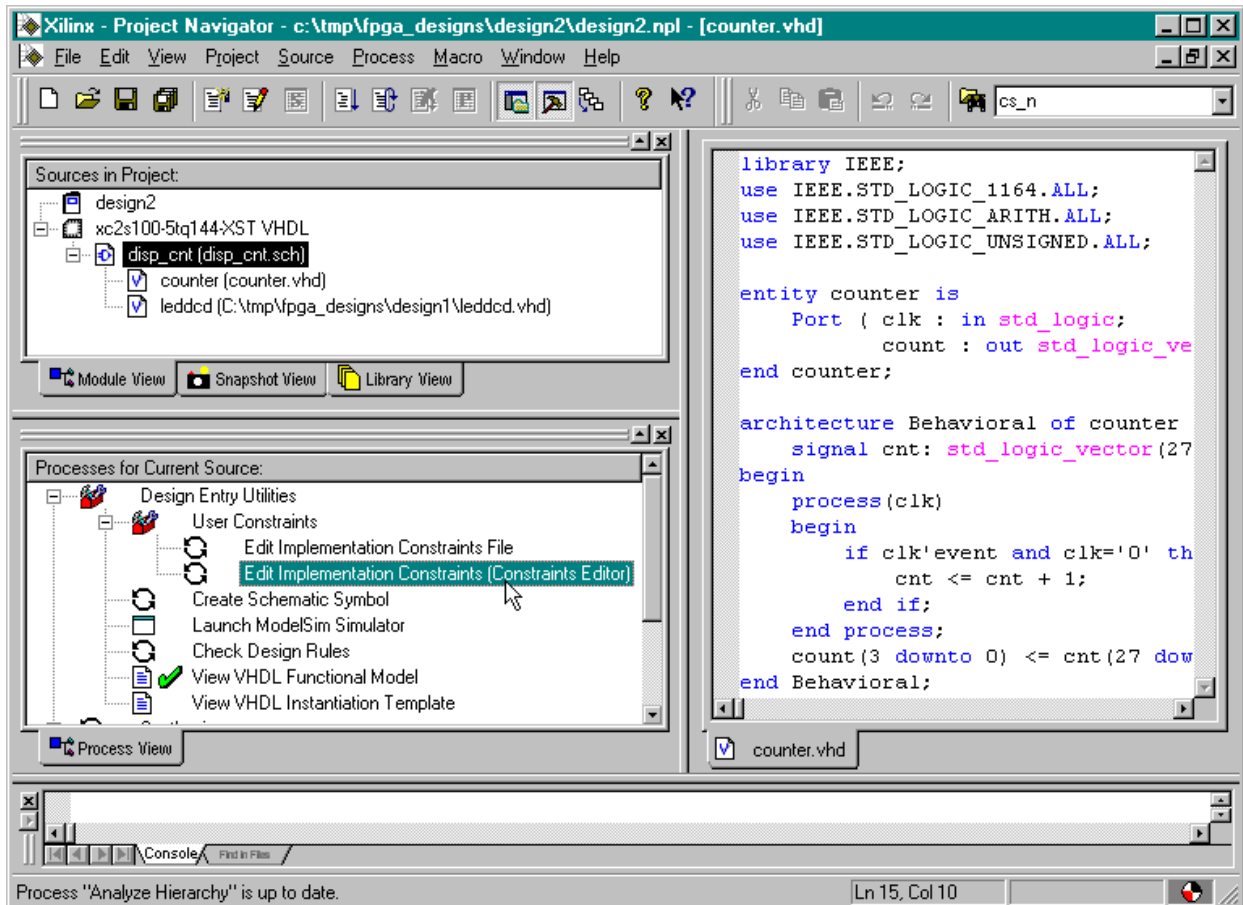

In the Ports tab of the **Constraint Editor** window, set the pin assignments for the clock input and LED segment drivers as follows:

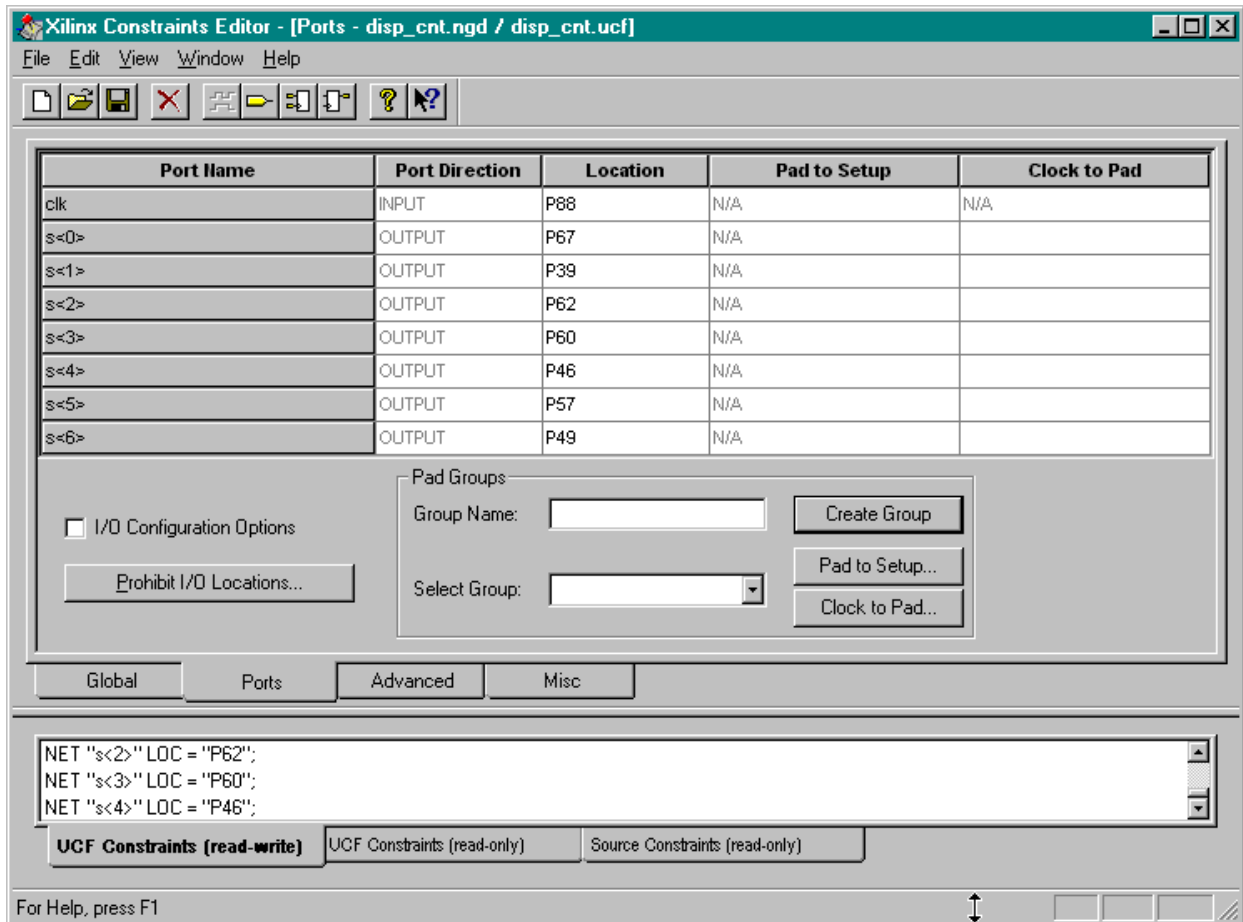

Assigning the **clk** input to pin P88 lets us use the onboard oscillator of the XSA Board to drive the counter. The output assignments connect the displayable counter to the seven-segment LED on the XSA Board as in the previous design example.

## Synthesizing the Logic Circuitry for the Design

Now we can synthesize the logic circuit netlist by highlighting the top-level **disp\_cnt** module in the Sources pane and double-clicking the Synthesize process.

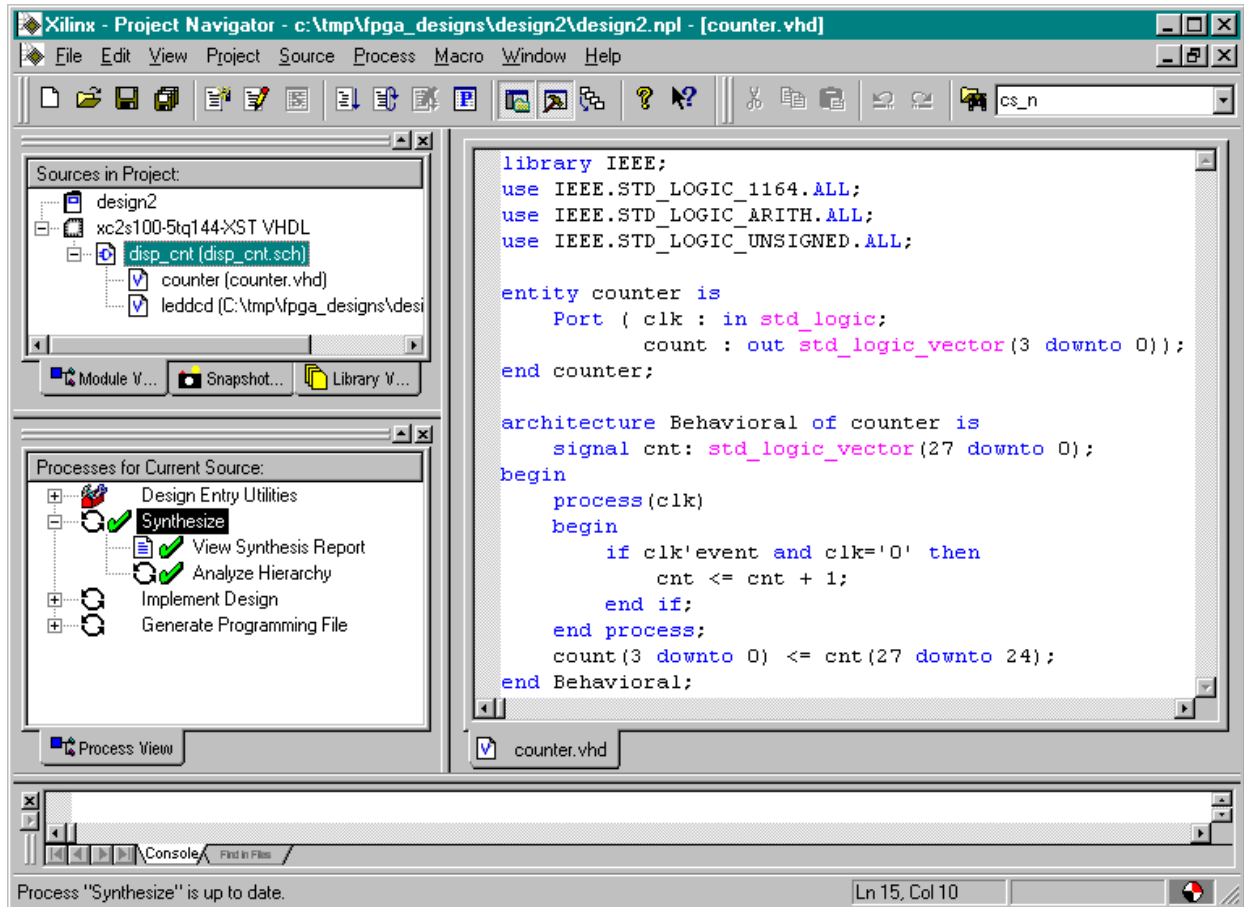

## Implementing the Logic Circuitry in the FPGA

Once the netlist is synthesized, we can begin the process of mapping, placing and routing it into the FPGA. Highlight the disp\_cnt object in the Sources pane and then double-click the Implement Design process. There should be no problems implementing the design in the FPGA.

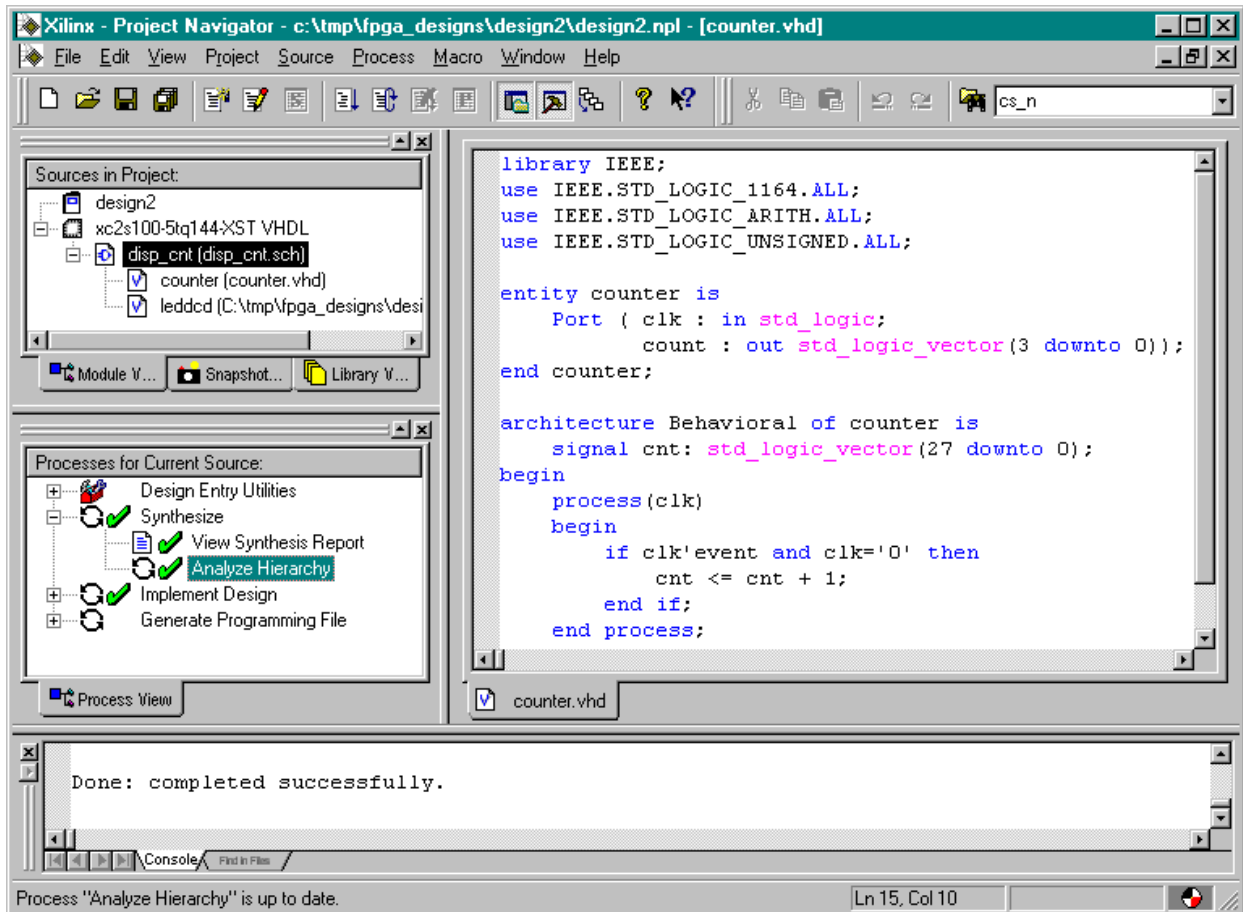

## Checking the Implementation

After the implementation process is done, we can check the logic utilization by double-clicking on the Place & Route Report process. Near the top of the file we find:

Device utilization summary:

Number of External GCLKIOBs	1 out of 4	25%
Number of External IOBs	7 out of 92	7%
Number of LOCed External IOBs	7 out of 7	100%
Number of SLICES	18 out of 1200	1%

The displayable counter consumes 18 of the 1200 slices in the FPGA. Each slice contains two CLBs, so the displayable counter uses a maximum of 36 CLBs. The 28-bit counter requires at least 28 CLBs and the LED decoder requires 7 CLBs so this totals to 35 CLBs.

As a precaution, we should also double-click the Pads Report and check that the pin assignments for the clock input and LED decoder outputs match the assignments we made with the Constraint Editor:

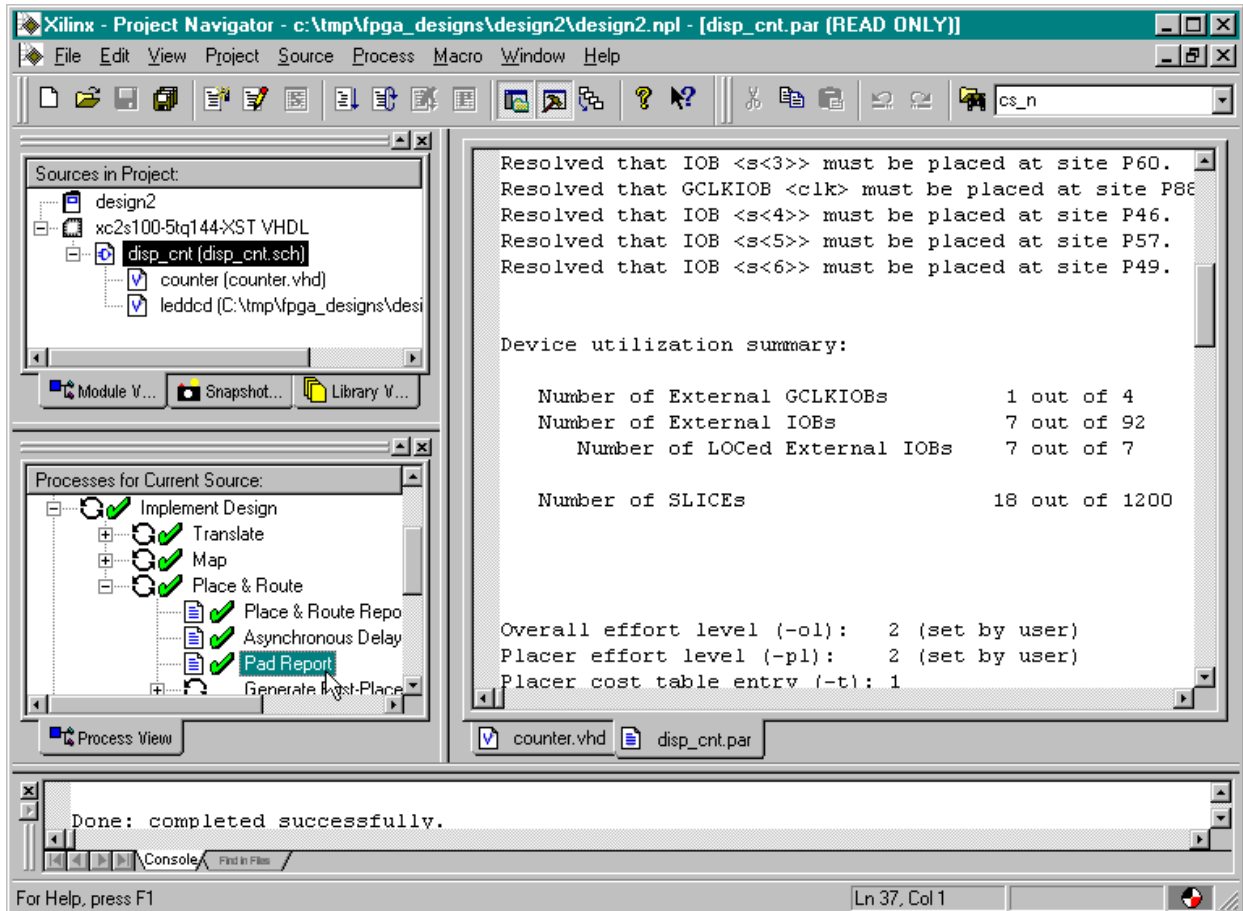

Pinout by Signal Name:

Signal Name	Pin Name	Pin Number	Direction	IO Standard	IO Ban
clk		P88	INPUT	LVTTL	4
s<0>	D7	P67	OUTPUT	LVTTL	3
s<1>	DIN_D0	P39	OUTPUT	LVTTL	2
s<2>	D6	P62	OUTPUT	LVTTL	3
s<3>	D5	P60	OUTPUT	LVTTL	3
s<4>	D2	P46	OUTPUT	LVTTL	2
s<5>	D4	P57	OUTPUT	LVTTL	3
s<6>	D3	P49	OUTPUT	LVTTL	2

## Checking the Timing

We have the displayable counter synthesized and implemented in the XC2S100 FPGA with the correct pin assignments. But how fast can we run the counter? To find out, double-click on the Generate Post-Place & Route Static Timing process. This will determine the maximum delays between logic elements in the design taking into account logic and wiring delays for the routed circuit.

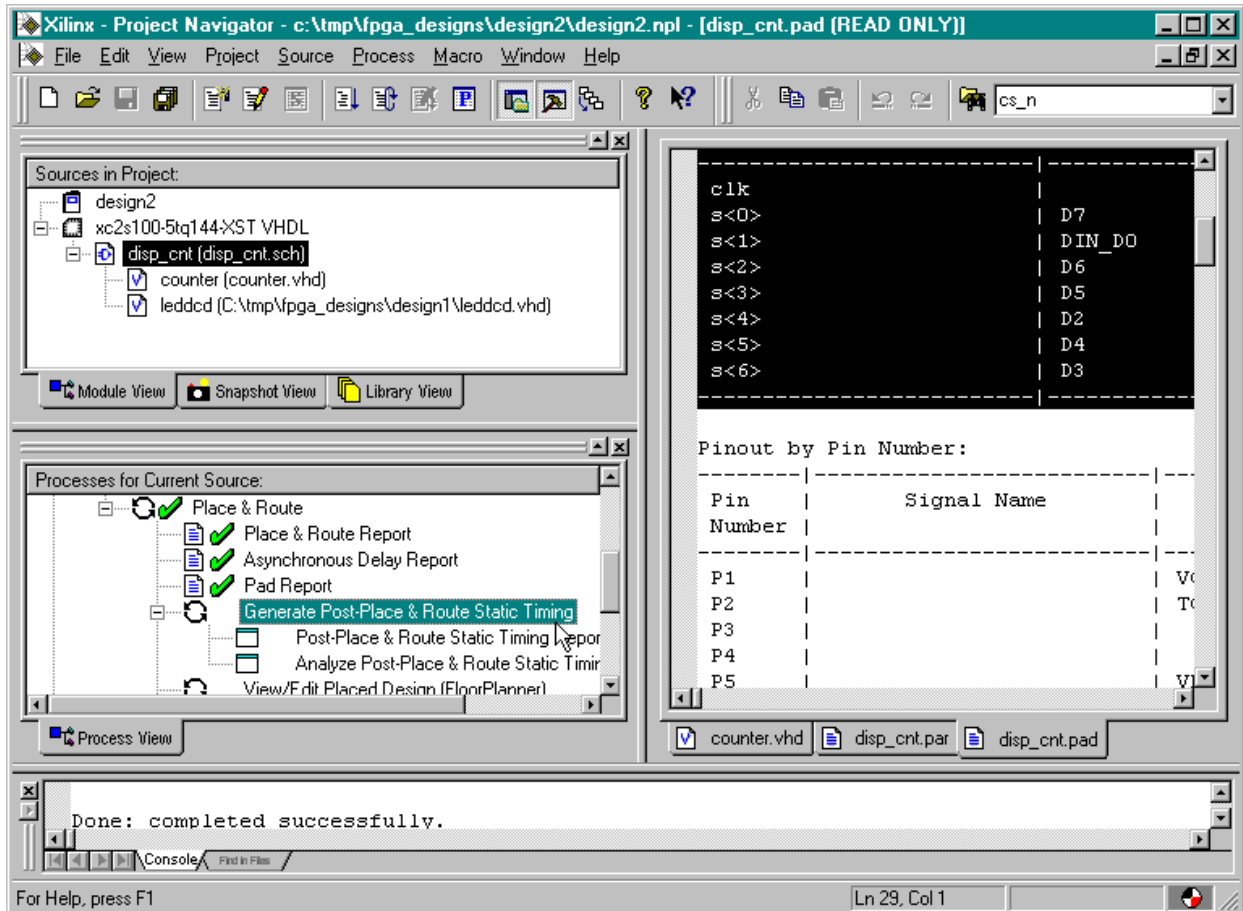

After the static timing delays are calculated, double-click the Post-Place & Route Static Timing Report to view the results of the analysis.

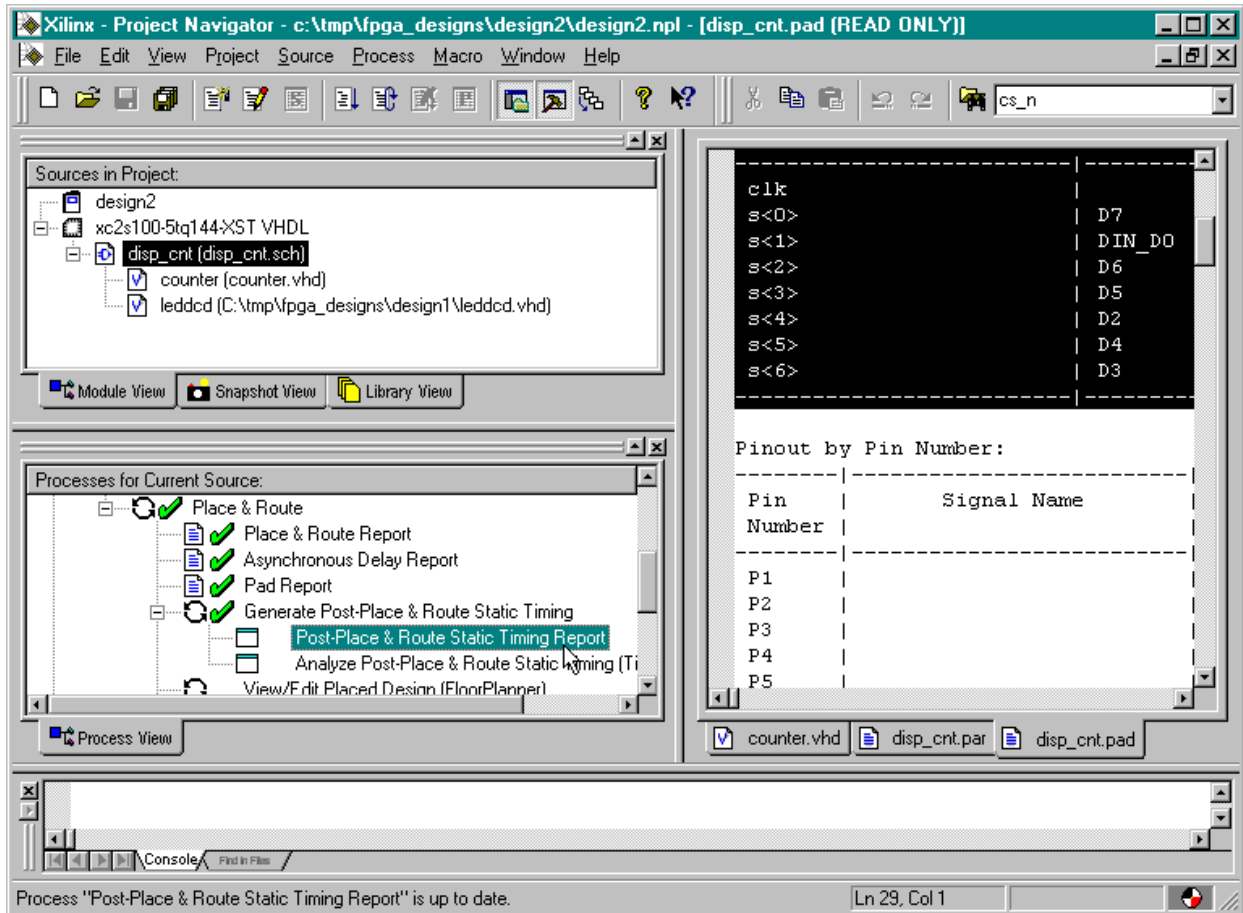



Now the **Timing Analyzer** window appears. From the information shown in the right-hand pane we see the minimum clock period for this design is 6.247 ns which means the maximum clock frequency is 160.1 MHz. The maximum clock frequency on the XSA Board is 100 MHz which is well below the maximum allowable frequency for this design.

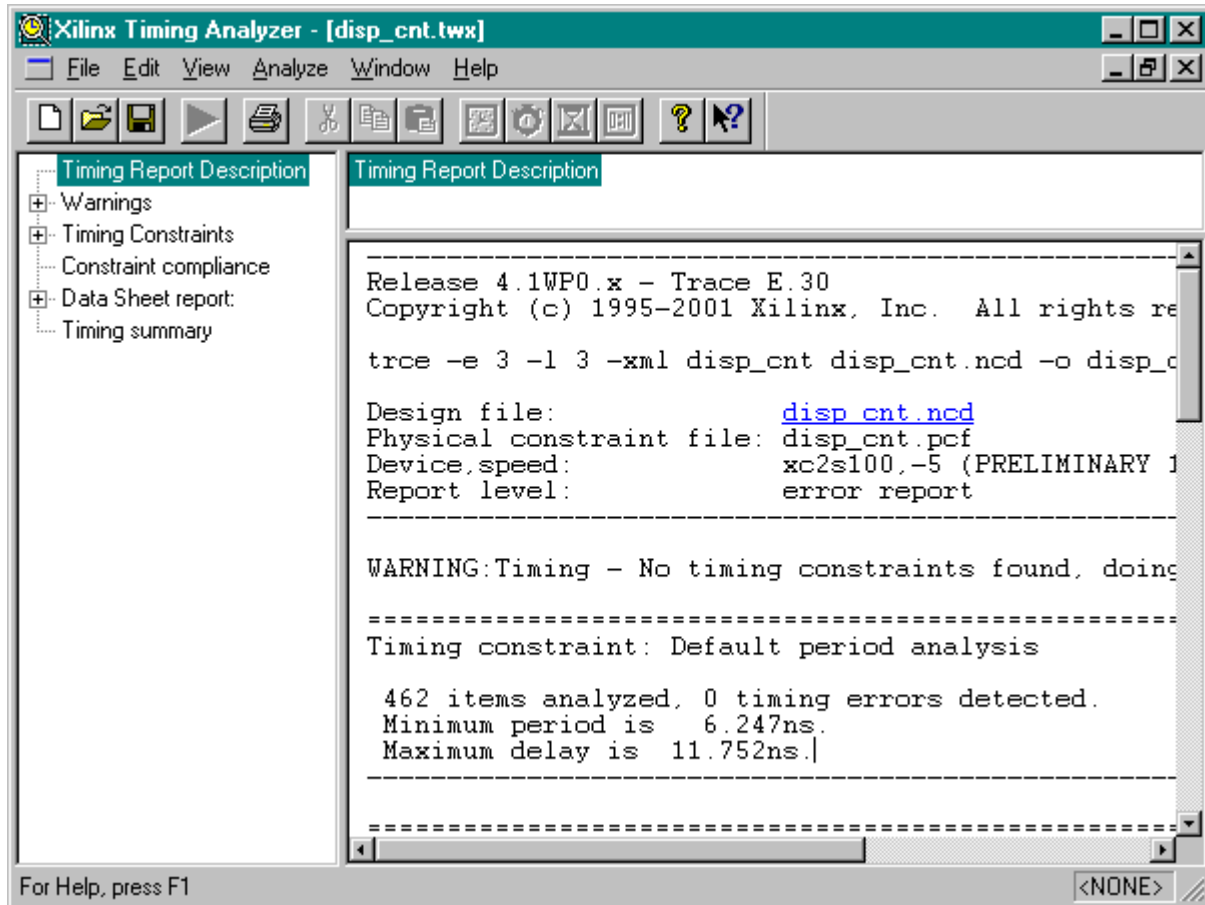

## Generating the Bitstream

Now that we have synthesized our design and mapped it to the FPGA with the correct pin assignments, we are ready to generate the bitstream that is used to program the actual chip. In this example, rather than use the gxsload utility we will employ the downloading utilities built into WebPACK. The iMPACT programming tool downloads the bitstream through the JTAG interface of the FPGA so we need to adjust the way the bitstream is generated to account for this. Right click on the Generate Programming File process and select the Properties... entry from the pop-up menu.

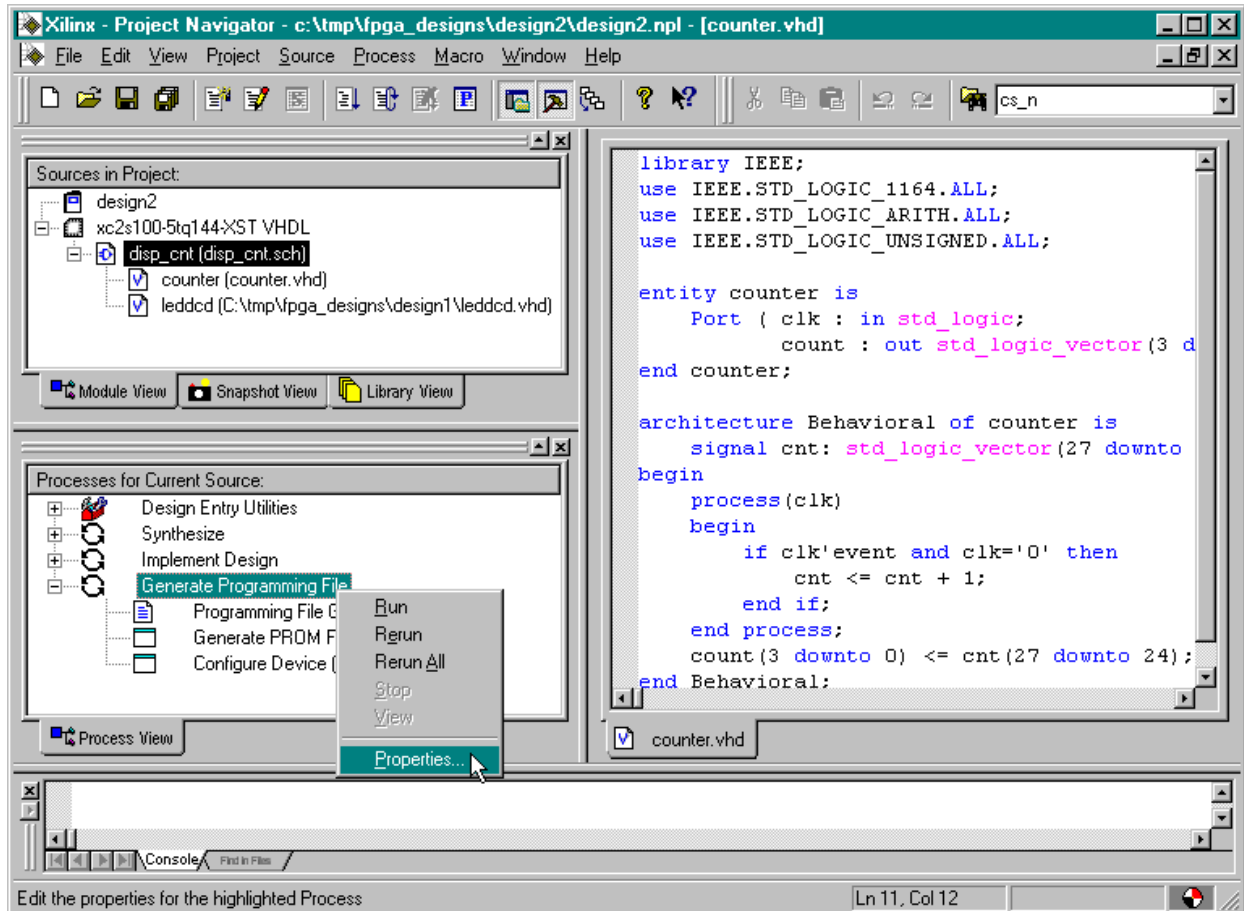

Select the Startup options tab of the Process Properties window. Change the Start-Up Clock property to JTAG Clock so the FPGA will react to the clock pulses put out by the iMPACT tool during the final phase of the downloading process. If this option is not selected, the FPGA will not finish its configuration process and it will fail to operate after the downloading completes. Note that the startup clock is only used to complete the configuration process; it has no effect on the clock that is used to drive the actual circuit after the FPGA is configured.

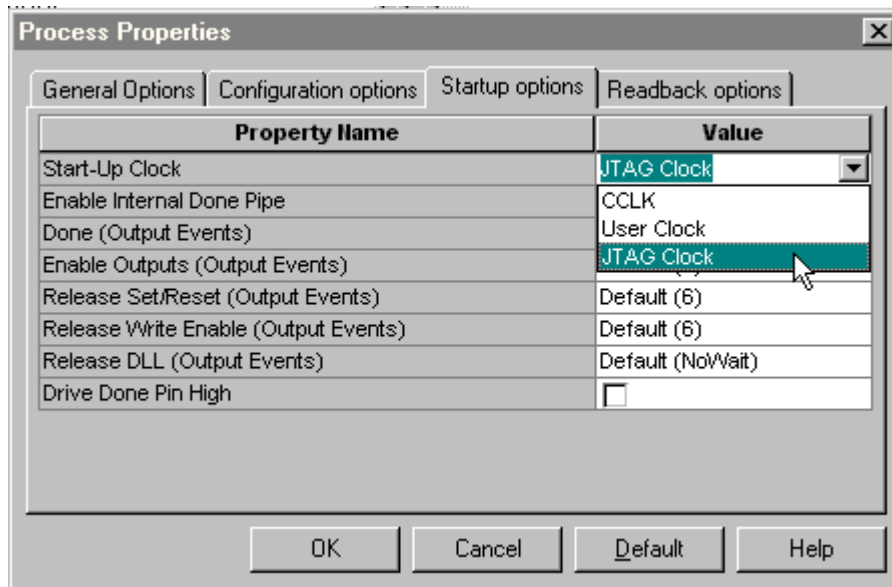

After setting the Start-Up Clock option, click on the OK button. Then highlight the disp\_cnt object in the Sources pane and double-click on the Generate Programming File process to create the bitstream file.

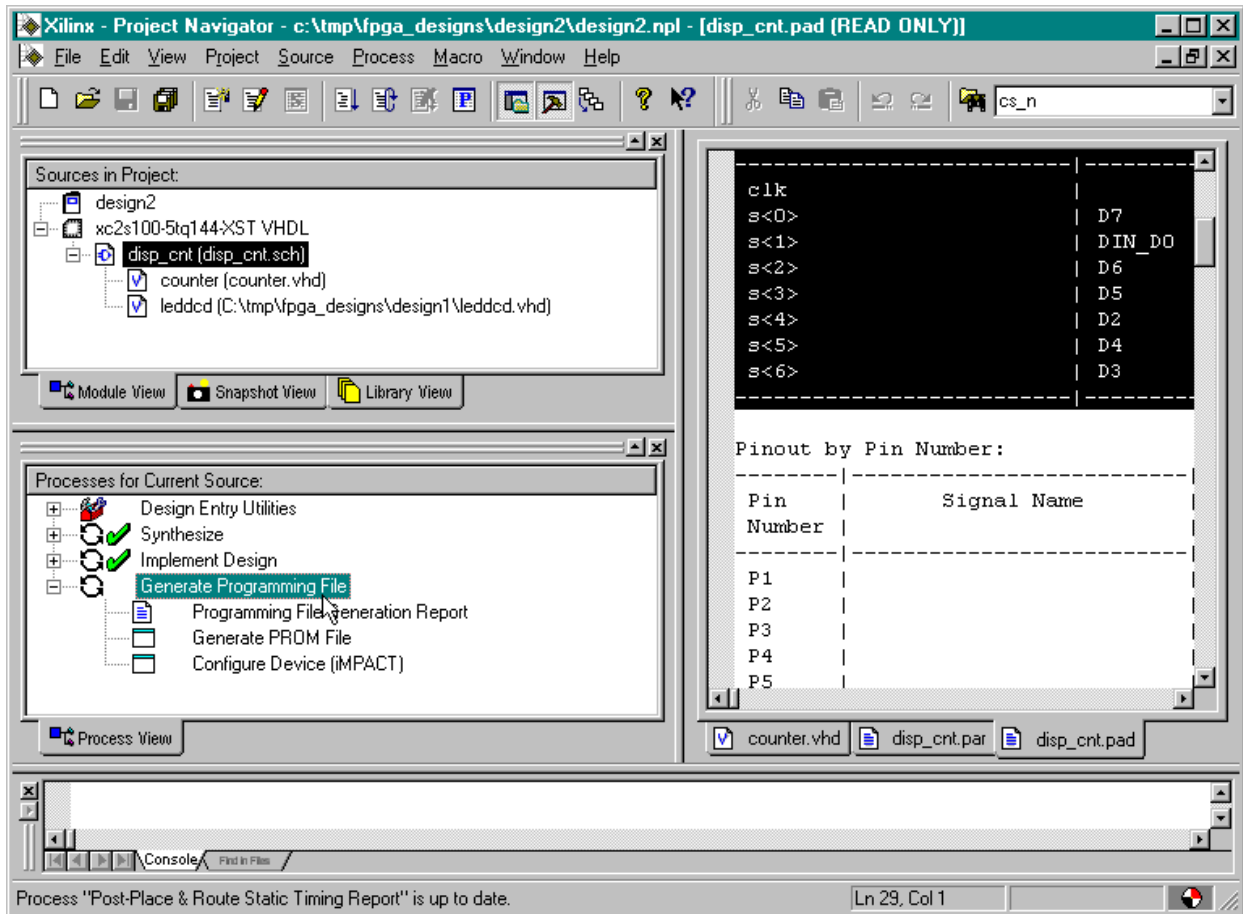

Within a few seconds, a  will appear next to the Generate Programming File process and a file detailing the bitstream generation process will be created. A bitstream file named disp\_cnt.bit can now be found in the design2 folder.

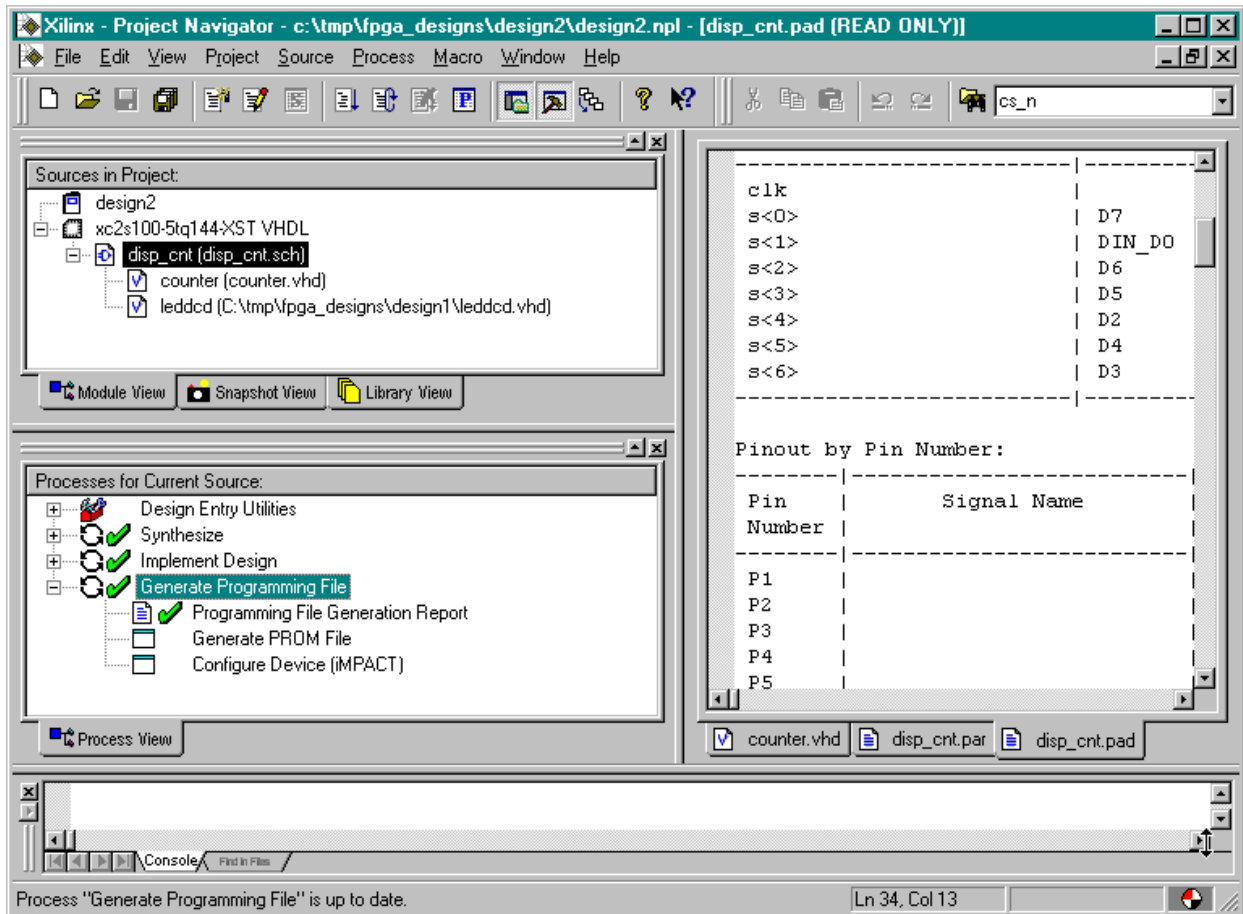

## Downloading the Bitstream

Before downloading the disp\_cnt.bit file, we must configure the interface CPLD on the XSA



board so it will work with the iMPACT programming tool. Double click the **GXSLOAD** icon and then drag & drop the piiijtag.svf file from the C:\XSTOOLS4\XSA folder into the **gxslod** window. Then click on the Load button and the CPLD will be reprogrammed in less than a minute.

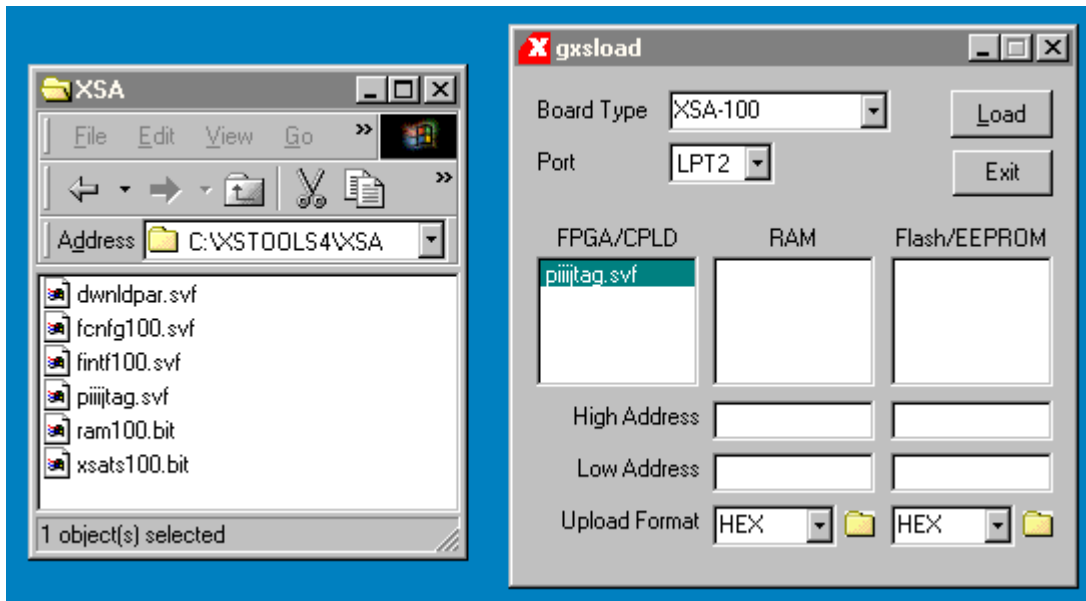

After the piiijtag.svf file is loaded into the XSA Board, move the shunt on jumper J9 from the **xs** to the **xi** position. The XSA Board is now setup so the FPGA can be programmed with the iMPACT programming tool. Note that this process only needs to be done once because the CPLD on the XSA Board will retain its configuration even when power is removed from the board. (If we want to go back to using the gxslod programming utility, we must move the shunt on J9 back to the **xs** position and download the dwnldpar.svf file into the CPLD.)

Now double-click on the Configure Device (iMPACT) process.

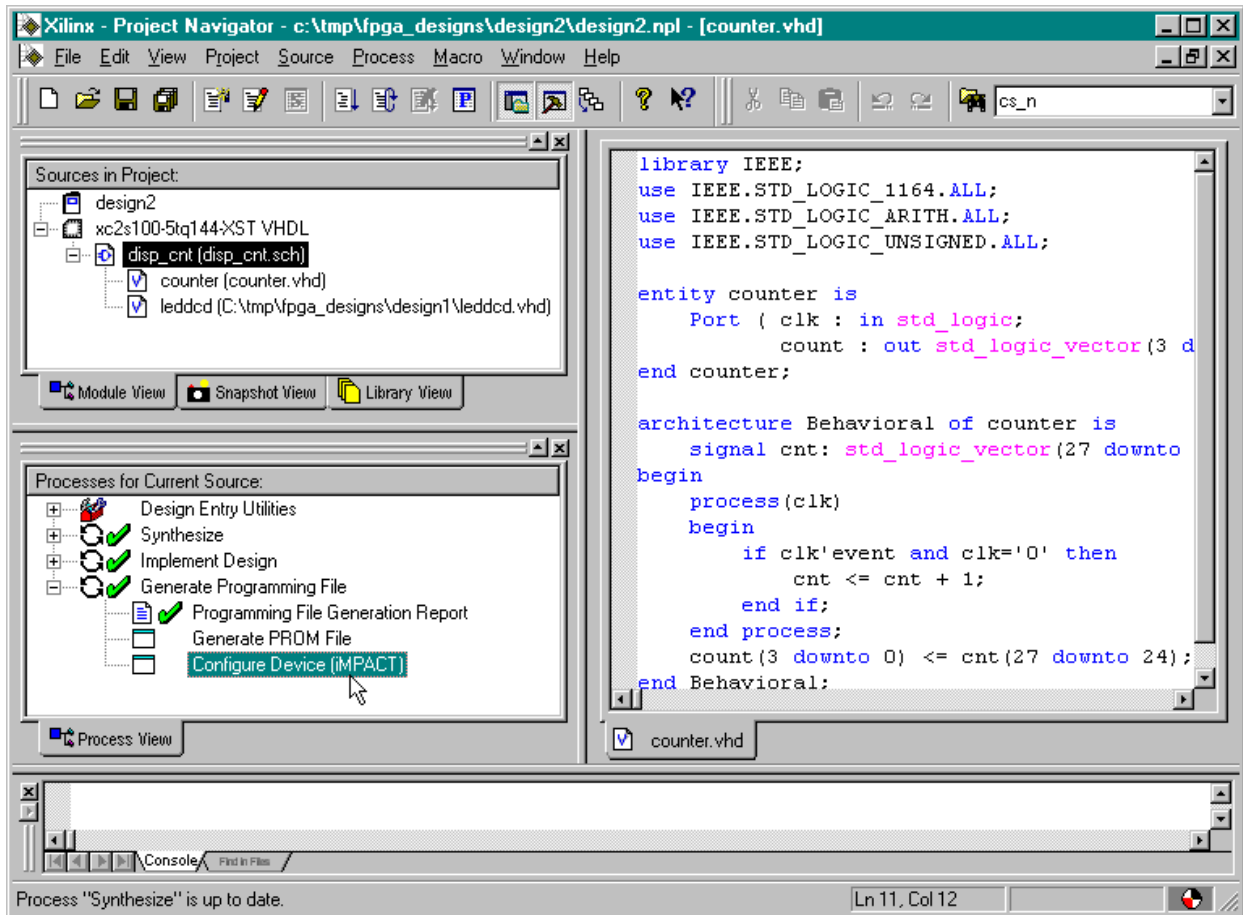

The **IMPACT** window will appear. Within a few seconds the XSA Board will be probed and the JTAG chain consisting of a single XC2S100 FPGA will be detected.

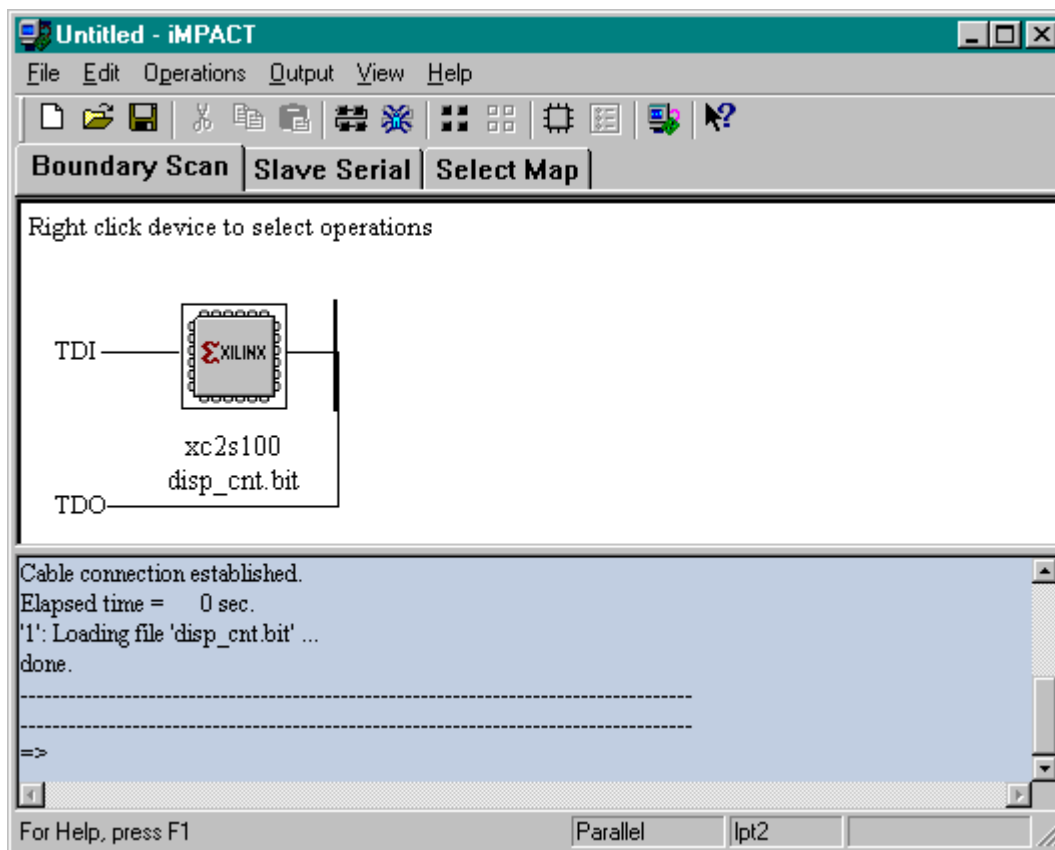



Click on the xc2s100 object in the **IMPACT** window to select this device as the target for configuration.

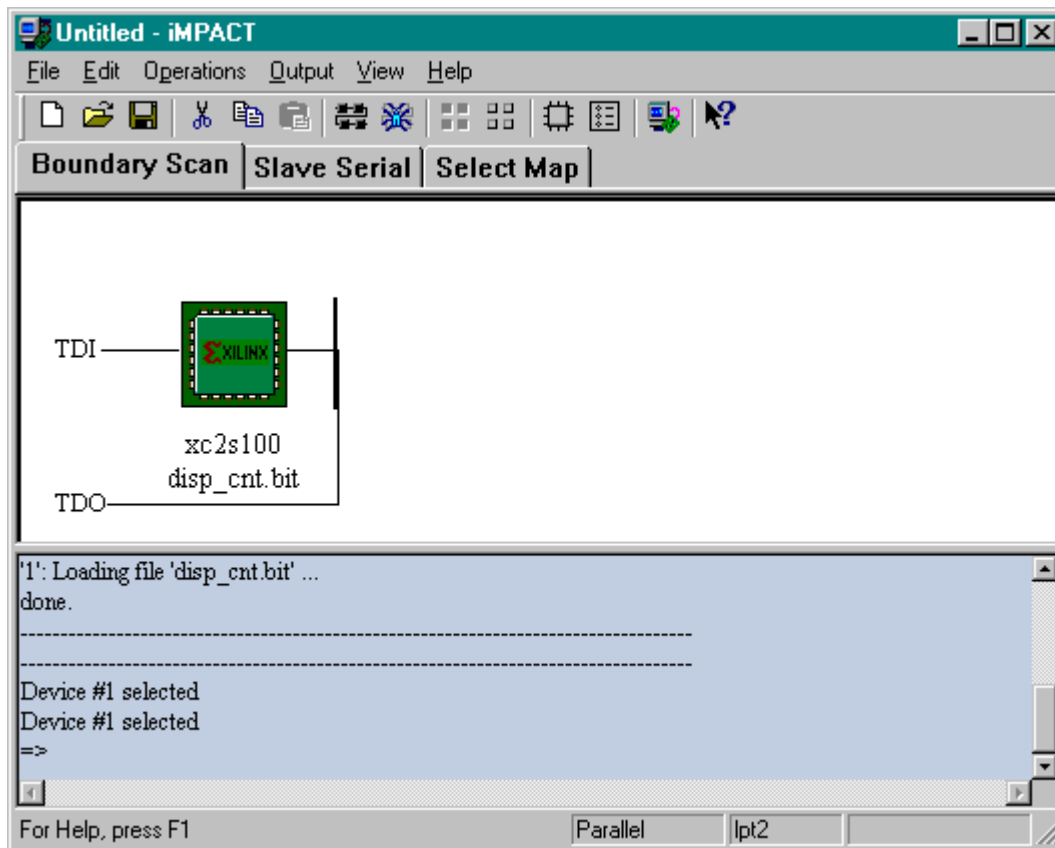

Now select the Operations → Program... menu item.

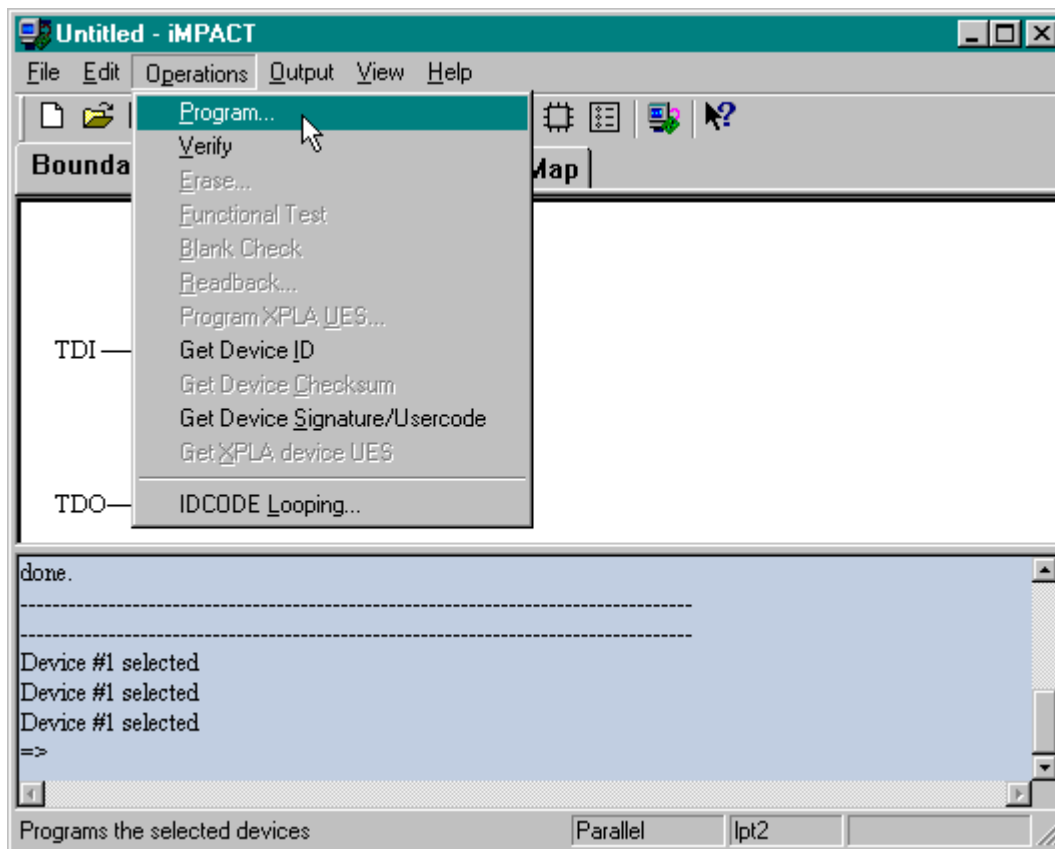

The **Program Options** window will appear. All we need to do at this point is click on the OK button to begin loading the disp\_cnt.bit file into the FPGA.

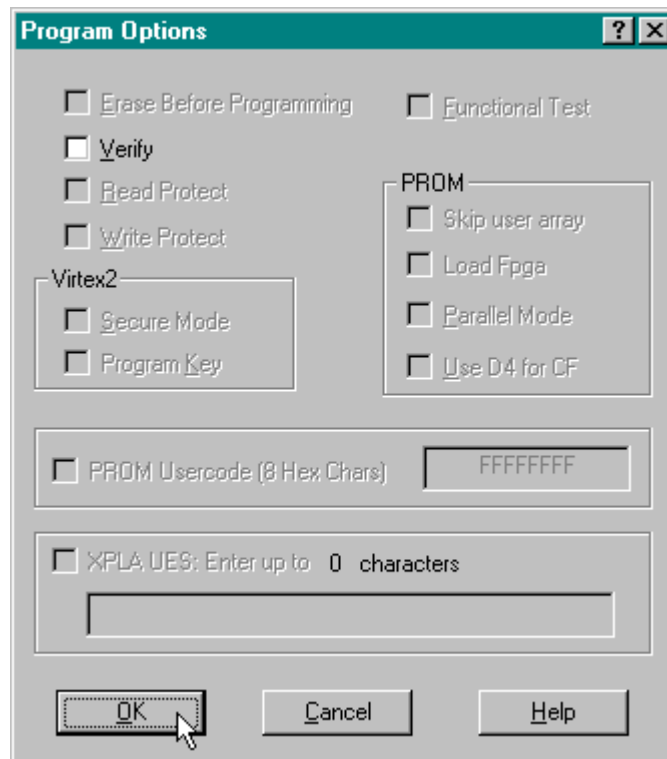

The progress of the bitstream download will be displayed. The download operation should complete within several seconds.

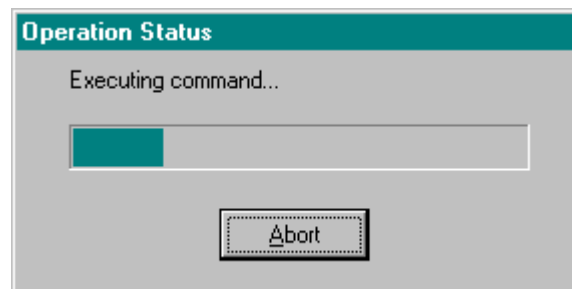

## Testing the Circuit

Once the XC2S100 FPGA on the XSA Board is programmed, the circuit will begin operating without any further action from us. The LED display should repeatedly count through the sequence 0, 1, 2, 3, 4, 5, 6, 7, 8, 9, A, B, C, D, E, F with a complete cycle taking 5.4 seconds.

# 5

---

## Going Further...

OK! You made it to the end! You have scratched the surface of programmable logic design, but how do you learn even more? Here are a few easy things to do:

- In the Project Navigator window, select Help⇒ISE Help Contents. You will be presented with a browser window containing topics that will let you learn more about the WebPACK software.
- Get *Essential VHDL* (ISBN:0-9669590-0-0) or *The Designer's Guide to VHDL* (ISBN:1-55860-270-4) to learn more about VHDL for logic design.
- Go to the Xilinx web site and read their application notes and data sheets.
- Read the *comp.arch.fpga* newsgroup for helpful questions and answers about programmable logic design.