

The Atari Historical Society
www.atari-history.com

POKEY
 COL2294

CONFIDENTIAL

REVISIONS				DRAWN BY.	DATE	 ATARI TITLE	ATARI INCORPORATED 1265 BORREGAS AVE. SUNNYVALE, CA. 94086		
SYM	DESCRIPTION	DATE	APPV'D	CHECKED	DATE		SIZE	DRAWING NO.	REV
B	RELEASE PER ECN 5320	5-30-82	<i>EW</i>	<i>[Signature]</i>	3-9-82	A	COL2294	B	
				ENGINEER	3/15/82	POKEY CHIP			
				ENGINEER MGR.	<i>[Signature]</i>	SCALE	-	SHEET	1 OF 41
				QUALITY ASSURANCE					
				MFG. ENGINEER					

TABLE OF CONTENTS:

1. GENERAL DESCRIPTIONpage 3
 2. AUDIOpage 3
 3. KEYBOARD SCANpage 10
 4. POT PORTSpage 15
 5. TIMERSpage 17
 6. RANDOM NUMBER GENERATORpage 17
 7. SERIAL I/O PORTpage 18
 8. IRQ INTERRUPTSpage 23
 9. ELECTRICAL PARAMETERSpage 25
 A. GENERALpage 25
 B. D.C. AND OPERATING CHARACTERISTICSpage 25
 C. DYNAMIC OPERATING CHARACTERISTICSpage 28
 D. WRITE I/O TIMINGpage 29
 E. READ I/O TIMINGpage 30
 F. MISC. I/O TIMINGpage 31

TABLE OF ILLUSTRATIONS:

1. AUDIO NOISE FILTERSpages 5 & 6
 2. MUSICAL NOTE TABLEpage 9
 3. KEY SCAN FLOW CHARTpage 11
 4. TYPICAL KEYBOARD CONFIGURATIONpage 12
 5. KEY SCAN LINE TIMINGpage 13
 6. INTERNAL KEY SCAN LOGIC (BLOCK DIAGRAM).....page 14
 7. INTERNAL POT PORT LOGIC (BLOCK DIAGRAM).....page 16
 8. POKEY ADDRESS TABLEpage 32
 9. POKEY PIN LISTpage 33
 10. POKEY BONDING DIAGRAM.....page 34
 11. POKEY MOS LOGIC.....pages 35 - 41



TITLE			
POKEY CHIP			
DRAWING NO	CO12294	REV	B
SHEET	2	OF	4

1. GENERAL DESCRIPTION:

There are four semi-independent audio channels, each with its own frequency, noise and volume control. Each channel has an eight bit "divide by N" frequency divider and an eight bit control register, which selects the noise (polynomial counter) content and volume.

There are six key scan lines (K0-K5), which holds a value from 00 to 3F. There are two sense lines. One of the sense lines is for the full decode of the six scan lines. The other sense line is for decoding only the codes (CTRL, SHIFT, and BREAK-key).

There are eight pot ports for measuring input rise time. Each input has an eight bit counter which is clocked every TV line. Each input also has a dump transistor which is turned on or off by software.

There are three timers which use the audio channels. If start timer (STIMER) is enabled, the audio channels are reset.

There is a random number generator which is eight bits from a polynomial counter.

There is a serial I/O port. The serial port consists of a serial output line, a serial input line, a serial output clock line, and a bi-directional serial data clock line. Also there are control registers which are used to configure the serial port.

There are eight IRQ interrupts. They are BREAK key, OTHER key, SERIAL INPUT READY, SERIAL OUTPUT NEEDED, TRANSMISSION FINISHED, TIMER #4, TIMER #2, and TIMER #1. These interrupts can be enabled or disabled by software. There is also a register to read interrupt status.

2. AUDIO:

There are four semi-independent audio channels, each with its own frequency, noise, and volume control. Each channel has an eight bit "divide by N" frequency divider, controlled by an eight bit register (AUDFX). Each channel also has an eight bit control register (AUDCX) which selects the noise (polynomial counter) content and the volume.

All four frequency dividers can be clocked simultaneously from 64 KHZ or 15 KHZ by AUDCTL bit 0. Frequency dividers 1 and 3 can alternately be clocked from



TITLE

POKEY CHIP

DRAWING NO.

CO12294

REV

B

SHEET

3

OF

4

2. AUDIO (continued)

1.79 MHZ by setting AUDCTL bits 5 and 6. Frequency dividers 2 and 4 can alternately be clocked with the output of dividers 1 and 3 by setting AUDCTL bits 4 and

3. This allows the following options: 4 channels of 8 bit resolution, 2 channels of 16 bit resolution, or 1 channel of 16 bit resolution and 2 channels of 8 bit resolution.

There are three polynomial counters (17 bit, 5 bit and 4 bit) used to generate random noise. The 17 bit poly counter can be reduced to a 9 bit poly counter by bit 7 of AUDCTL. These counters are clocked by 1.79 MHZ. Their outputs, however, can be sampled independently by the four audio channels at a rate determined by each channel's frequency divider. Thus each channel appears to contain separate poly counters clocked at its own frequency. This poly counter noise sampling is controlled by bits 5, 6, and 7 of each AUDCX register. Because the poly counters are sampled by the "divide by N" frequency divider, the output obviously cannot change faster than the sampling rate. In these modes (poly noise outputted), the dividers are therefore acting as "low pass" filter clocks, allowing only the low frequency noise to pass.

The output of the noise control circuit described above consists of pure tones (square wave type), or polynomial counter noise at a maximum frequency set by the "divide by N" counter (low pass clock). This output can be routed through a high pass filter if desired by use of bits 1 and 2 of AUDCTL.

The high pass filter consists of a "D" flip flop and an exclusive-OR Gate. The noise control circuit output is sampled by this flip flop at a rate set by the "High Pass" clock. The input and output of the Flip Flop pass through the exclusive-OR Gate. However, if it is lower than the clock rate, the flip flop output will tend to follow the input and the two exclusive-OR Gate inputs will mostly be identical (11 or 00) giving very little output. This gives the effect of a crude high pass filter, passing noise whose minimum frequency is set by the high pass clock rate. Only channels 1 and 2 have such a high pass filter. The high pass clock for channel 1 comes from the channel 3 divider. The high pass clock for channel 2 comes from the channel 4 divider. This filter is included only if bit 1 or 2 of AUDCTL is true.

A volume control circuit is placed at the output of each channel. This is a crude 4 bit digital to analog converter that allows selection of one of 16 possible output current levels for a logic true audio input. A logic zero audio input to this volume circuit always gives an open circuit (zero current) output. The volume selection is controlled by bits 0 through 3 of AUDCX. "Volume Control only" mode



TITLE	POKEY CHIP		
DRAWING NO.	COL2294	REV B	SHEET 4 OF 41

2. AUDIO (continued)

can be invoked by forcing this circuit's audio input true with bit 4 of AUDCX. In this mode the dividers, noise counters, and filter circuits are all disconnected from the channel output. Only the volume control bits (0 to 3 of AUDCX) determine the channel output current.

The audio output of any channel can be completely turned off by writing zero to the volume control bits of AUDCX. All ones give maximum volume.

AUDIO NOISE FILTERS:

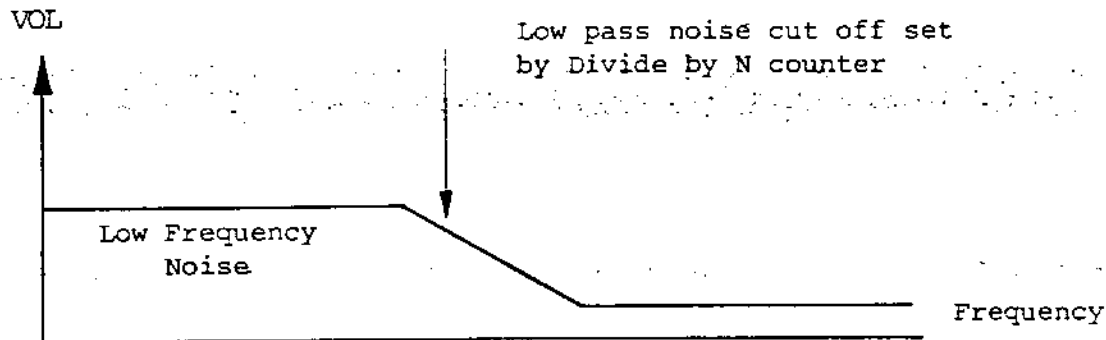

Any channel noise output (without high pass filter)

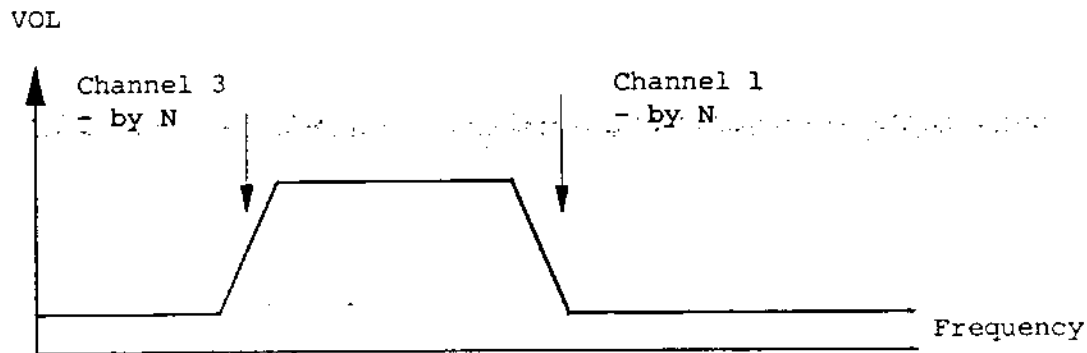

Channel 1 output (with high pass filter)

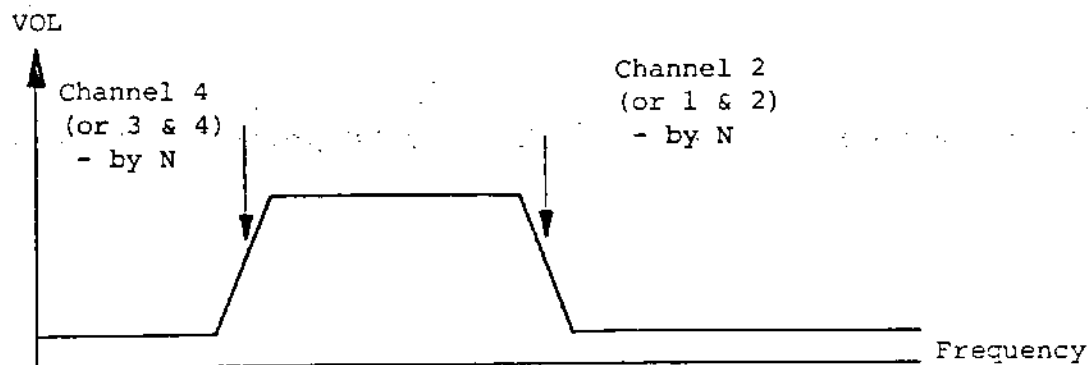

Channel 2 output (with high pass filter)

ALDIO NOISE FILTERS (continued):

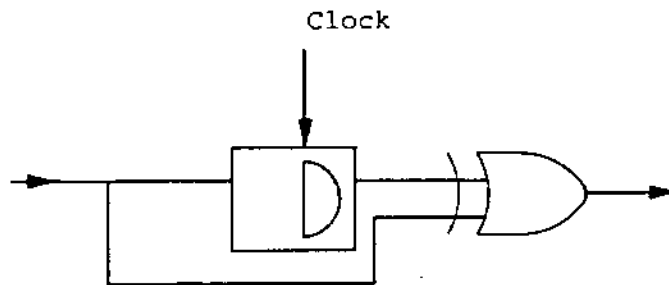

AUDCTL (Audio Control) (08): This address writes data into the Audio Mode Control Register. (Also see SKCTL two-tone bit 3 and notes).

D7	D6	D5	D4	D3	D2	D1	D0
----	----	----	----	----	----	----	----

- D7 Change 17 bit poly into a 9 bit below poly.
- D6 Clock Channel 1 with 1.79 MHZ, instead of 64 KHZ.
- D5 Clock Channel 3 with 1.79 MHZ, instead of 64 KHZ.
- D4 Clock Channel 2 with Channel 1, instead of 64 KHZ (16 BIT).
- D3 Clock Channel 4 with Channel 3, instead of 64 KHZ (16 BIT).
- D2 Insert Hi Pass Filter in Channel 1, clocked by Channel 3.
(See section II.)
- D1 Insert Hi Pass Filter in Channel 2, clocked by Channel 4.
- D0 Change Normal 64 KHZ frequency, into 15 KHZ.

Exact Frequencies: The frequencies given above are approximate. The Exact Frequency (F_{in}) that clocks the divide by N counters is given below (NTSC only, PAL different).

F_{in} (Approximate)	F_{in} (Exact)	
1.79 MHZ	1.78979 MHZ	- Use modified formula for F_{out}
64 KHZ	63.9210 KHZ	
15 KHZ	15.6999 KHZ	- Use normal formula for F_{out}



Audio (continued):

The Normal Formula for output frequency is:

$$F_{out} = F_{in}/2N$$

Where N = the binary number in the frequency register (AUDF), plus 1 (N=AUDF+1).

The MODIFIED FORMULA should be used when $F_{in} = 1.79$ MHZ and a more exact result is desired:

$$F_{out} = \frac{F_{in}}{2(AUDF + M)}$$

Where: M = 4 if 8 bit counter (AUDCTL bit 3 or 4 = 0)

M = 7 if 16 bit counter (AUDCTL bit 3 or 4 = 1)

AUDF1, AUDF2, AUDF3, AUDF4, (Audio Frequency) (00, 02, 04, 06):

These addresses write data into each of the four Audio Frequency Control Registers.

Each register controls a divide by "N" counter.

D7	D6	D5	D4	D3	D2	D1	D0	"N"
0	0	0	0	0	0	0	0	1
0	0	0	0	0	0	0	1	2
ETC.								
1	1	1	1	1	1	1	1	256

Note: "N" is one greater than the binary number in Audio Frequency Register AUDF(X).

AUDC1, AUDC2, AUDC3, AUDC4 (Audio Channel Control) (01, 03, 05, 07):

These addresses write data into each of the four Audio Control Registers. Each Register controls the noise content and volume of the corresponding Audio Channel.

Noise Content or Distortion					Volume			
HEX	D7	D6	D5	D4	D3	D2	D1	D0
0	0	0	0	0				
2	0	0	1	0				
4	0	1	0	0				
6	0	1	1	0				
8	1	0	0	0				
A	1	X	1	0				
C	1	1	0	0				
1	X	X	X	1				
0					0	0	0	0
8					1	0	0	0
F					1	1	1	1

Divisor "N" set by audio frequency register.

- 17 BIT poly - 5 BIT poly - N
- 5 BIT poly - N - 2
- 4 BIT poly - 5 BIT poly - N
- 5 BIT poly - N - 2
- 17 BIT poly - N
- Pure Tone - N - 2
- 4 BIT poly - N
- Force Output (Volume only)
- Lowest Volume (Off)
- Half Volume
- Highest Volume

MUSICAL NOTE TABLE

PITCH VALUES FOR THE MUSICAL NOTES-AUDCTL =0, AUDC = hex AX

		<u>Hex</u>	<u>AUDF</u>	<u>Dec</u>
HIGH NOTES	C	1D		29
	B	1F		31
	A# or Bb	21		33
	A	23		35
	G# or Ab	25		37
	G	28		40
	F# or Gb	2A		42
	F	2D		45
	E	2F		47
	D# or Eb	32		50
	D	35		53
	C# or Db	39		57
	C	3C		60
	B	4G		64
	A# or Bb	44		68
	MIDDLE C	A	48	
G# or Ab		4C		76
G		51		81
F# or Gb		55		85
F		5B		91
E		60		96
D# or Eb		66		102
D		6C		108
C# or Db		72		114
C		79		121
B		80		128
A# or Bb		88		136
A		90		144
G# or Ab		99		153
G		A2		162
F# or Gb		AD		173
LOW : NOTES	F	B6		182
	E	C1		193
	D# or Eb	CC		204
	D	D9		217
	C# or Db	E6		230
	C	F3		243



3. KEYBOARD SCAN:

The $\overline{K0-K5}$ lines hold a 6 bit value from 00 to 3 F. This allows for decoding 64 keys. With external CMOS (4052) chips, a key matrix is formed. The value of the key selected by the key matrix is returned on the $\overline{KR1}$ line.

Internal to the Pokey is a 6 bit binary counter, a 6 bit compare latch, and an 8 bit keycode latch. A control state machine does debouncing of the keys.

When the keyboard scanner is enabled by the SKCTL register, the binary counter begins to count, once per line. If the $\overline{KR1}$ line goes low, the value of the binary counter is transferred to compare latch. This will be the key code to be debounced. If $\overline{KR1}$ goes low before the next time the binary counter equals the compare latch then there are two keys depressed and both are ignored. If the binary counter equals the compare latch and $\overline{KR1}$ is high, then the key is bouncing and is ignored, but if $\overline{KR1}$ is low then the key is valid and it is transferred to the keycode latch for reading by the CPU. An IRQ is also sent indicating the key is ready. As soon as $\overline{KR1}$ is low and the binary counter equals compare latch, the key is still depressed. As soon as $\overline{KR1}$ is high, then the key will be checked for debounce. The next time the binary counter equals the compare latch and $\overline{KR1}$ is high, then the key is debounced and another key can be looked for. But if $\overline{KR1}$ is low, then the key is bouncing and is assumed to be still pressed.

If the debounce is disabled, the Pokey forces the binary counter equal compare latch signal to a logic true value which will disable debounce.

$\overline{KR2}$ input is used to decode 3 keys. They are SHIFT, BREAK and CONTROL. They do not get debounced. They are decoded only at:

	$\overline{K0}$	$\overline{K1}$	$\overline{K2}$	$\overline{K3}$	$\overline{K4}$	$\overline{K5}$
BREAK	= 1	1	1	1	0	0
SHIFT	= 1	1	1	1	0	1
CONTROL	= 1	1	1	1	1	1

KBCODE (Keyboard Code) (09): This address reads the Keyboard Code, and is usually read in response to a Keyboard Interrupt (IRQ and bits 6 or 7 of IRQST). See IRQEN for information on enabling keyboard interrupts. See SKCTL bits 1 and 0 for key scan and debounce enable.

D7	D6	D5	D4	D3	D2	D1	D0
----	----	----	----	----	----	----	----

D7 = Control Key
D6 = Shift Key



KEYSCAN CONTROL FLOW CHART

LOOKING FOR A KEY

KEY BOUNCE

VALID KEY DEPRESSED

KEY DEBOUNCE

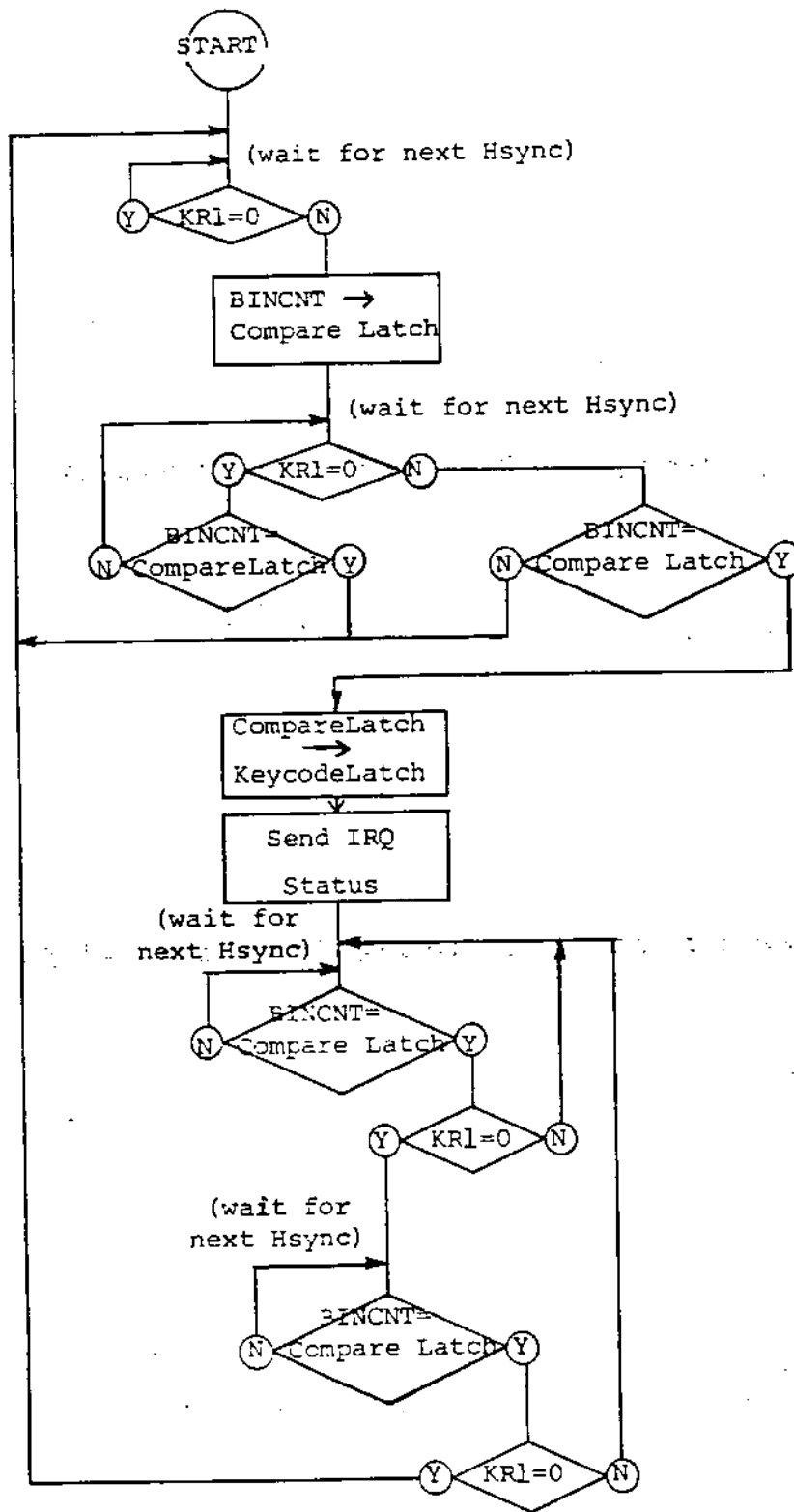

If Debounce Disable is in effect
then BINCNT = Compare Latch



4. POT PORTS

There are eight pot input lines. Each line has a dump transistor and an eight bit latch. There is a binary counter that will count to 228. The counter is reset by strobing POTGO, which also releases the dump transistors. It also starts the binary counter to count once per line. The pot lines now will start to charge. When each line reaches a logic one, it will cause the counter value to be latched into its corresponding latch to be read by the CPU. When the counter reaches 228, the dump transistor is turned back on to pull the pot lines back to ground. The value in the latches will remain until the next POTGO strobe. To operate pot port:

- 1) \$03 -> SKCTL ; Turn off init.
- 2) During Vblank service routine, perform the following instructions:
 - A) Read POT0 to POT7 registers
 - B) Write to POTGO register (strobe)

There is an ALLPOT register which allows the logic value of each pot line to be read by the CPU. The main use of Allpot is in the fast scan mode. This is done by:

- 1) Place Pokey in fast scan mode. (SEE SKCTLS)
- 2) Write to POTGO address.
- 3) Wait four cycles of computer clock.
- 4) Now the Allpot register can be read.

NOTE: This address (as well as the fast scan mode) is useful only when the charging capacitors on the P0 - P7 PADS are removed, unless the pads are driven by buffer drivers.

POT0 - POT7 (Pot Values) (00 - 07): These addresses read the value (0 to 228) of 8 pots (paddle controllers) connected to the 8 lines pot port. The paddle controllers are numbered from left to right when facing the console keyboard. Turning the paddle knob clockwise results in decreasing pot values. The values are valid only after 228 TV lines following the "POTGO" command described below or after ALLPOT changes.

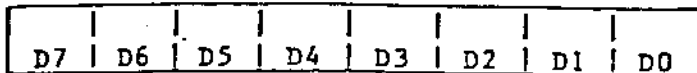

Each Pot Value (0-228)

ALLPOT (All Pot Lines Simultaneously) (08): This address reads the present digital value of the eight line pot port.

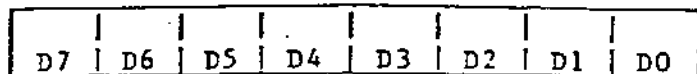

Pot number:

7 6 5 4 3 2 1 0

8 Pot Line States

- 0 = Pot register value is valid.
- 1 = Pot register value is not valid.



TITLE

POKEY CHIP

DRAWING NO. C012294

REV B

SHEET 15

OF 41

POTGO (Start Pot Scan) (0B):

No Data Bits Used

This write address starts the pot scan sequence. The pot values (POT0 - POT7) should be read first. This write strobe is then used causing the following sequence:

- 1) Scan Counter cleared to zero.
- 2) Capacitor dump transistors turned off.
- 3) Scan Counter begins counting.
- 4) Counter value captured in each of 8 registers (POT0 - POT7) as each pot line crosses trigger voltage.
- 5) Counter reaches 228, capacitor dump transistors turned on.

5. TIMERS:

Three of the audio channels can be used as timers. Audio channels 1, 2, and 4 are the channels that will cause IRQ interrupts for the timers. If interrupts are enabled, the interrupts will be caused by the audio channel crossing zero. The audio channel divide can be set to their "AUDF" value by strobing STIMER register. By strobing STIMER, the audio outputs are forced to a known state which are logic high for channels 1 and 2, and logic low for channels 3 and 4.

STIMER (Start TIMER) (09):

NOT USED

6. RANDOM NUMBER GENERATOR:

There is a seventeen bit polynomial counter that the CPU can read eight bit of the counter. The polynomial counter can be changed to nine bits by use of AUDCTL. If the Pokey is in the initial state (see SKCTLS), the counter is set to all ones state, therefore, the CPU will read \$FF.

RANDOM (Random Number Generator) (0A): This address reads the high order 8 bits of a 17 bit polynomial counter (9 bit, if bit 7 of AUDCTL = 1).

D7	D6	D5	D4	D3	D2	D1	D0
----	----	----	----	----	----	----	----



TITLE	POKEY CHIP		
DRAWING NO.	COL2294	REV B	SHEET 17 OF 4

7. SERIAL PORT

The serial port consists of a serial data output (transmission) line, a serial data input (receiver) line, a serial output clock line, a bi-directional serial data clock line, and other miscellaneous control lines described in the Operating System Manual. Data is transmitted and received as 8 bits of serial data preceded by a logic zero start bit, and succeeded by a logic true stop bit. Input and output clocks are equal to the baud (bit) rate, not 16 times baud rate. Transmitted data changes when the output clock goes true. Received data is sampled when the input clock goes to zero.

Serial Output: The transmission sequence begins when the processor writes 8 bits of parallel data into the serial output register (SEROUT). When any previous data byte transmission is finished the hardware will automatically transfer new data from (SEROUT) to the output shift register; interrupt the processor to indicate an empty (SEROUT) register (ready to be reloaded with the next byte of data), and automatically serially transmit the shift register contents with start-stop bits attached. If the processor responds to the interrupt, and reloads SEROUT before the shift register is completely transmitted, the serial transmission will be smooth and continuous.

Output data is normally transmitted as logic levels (+4V= true, 0V= false). Data can also be transmitted as two tone information. This mode is selected by bit 3 of SKCTL. In this mode audio channel 1 is transmitted in place of logic true, and audio channel 2 in place of logic zero. Channel 2 must be the lower tone of the tone pair.

The processor can force the data output line to zero (or to audio channel 2, if in two tone mode) by setting bit 7 of SKCTL. This is required to force a break (10 zeros) code transmission.

Serial Output Clock: The serial output data always changes when the serial output clock goes true. The clock then returns to zero in the center of the output data bit time.

The baud (bit) rate of the data and clock is determined by audio channel 4 audio channel 2, or by the input clock, depending on the serial mode selected by bits 4, 5, and 6 of SKCTL. (See chart at end of this section.)

Serial Input: The receiving sequence begins when the hardware has received a complete 8 bit serial data word plus start and stop bits. This data is automatically transferred to the 8 bit parallel input register (SERIN), and the processor is interrupted to indicate an input data byte ready to read in SERIN. The processor must



TITLE

POKEY CHIP

DRAWING NO. C012294

REV B

SHEET 18

OF 4

Serial Input (continued)

respond to this interrupt, and read SERIN, before the next input data word reception is complete, otherwise an input data "over-run" will occur. This over-run will be indicated by bit 5 of SKSTAT (if bit 5 of IRQST is not RESET (true) before next input complete), and means input data has been lost. This bit should be tested whenever SERIN is read. Bit 7 of SKSTAT should also be tested to detect frame errors caused by extra (or missing) data bits.

Direct Serial Input: The serial data input line can be read directly by the microprocessor if desired, ignoring the shift register, by reading bit 4 of SKSTAT.

Bi-Directional Clock: This clock line is used to either receive a clock from an external clock source for clocking transmitted or received data, or is used to supply a clock to external devices indicating the transmit or reception rate. This clock line direction is determined by the serial mode selected by bits 4, 5, and 6 of SKCTL. (See mode chart at the end of this section.) Transmitted data changes on the rising edge of this clock. Received data is sampled on the trailing edge of this clock.

Asynchronous Serial Input: Unclocked serial data (at an approximately known (+5%) rate) can be received in the asynchronous modes. The receive (input) shift register is clocked by audio channel 4. Channels 3 and 4 should be used together (AUDCTL bit 3 = 1) for increased resolution. In asynchronous modes, channels 3 and 4 are reset by each start bit at the beginning of each serial data byte. This allows the serial data rate to be slightly different from the rate set by channels 3 and 4.

Serial Mode Control: There are 6 useful modes (of the possible 8) controlled by bits 4, 5, and 6 of SKCTL. These are described on the next page.

Note that two tone output (bit 3 of SKCTL) may be used in any of these modes except for the bottom pair. This is because channel 2 is used to set the output transmit rate and is therefore not available for one of the two tones.

Note that the output clock rate is identical to the output data rate.



TITLE	POKEY CHIP		
DRAWING NO	0012294	REV 3	SHEET 19 OF 4

SKCTL (Serial Port Control) (0F): This address writes data into the register that controls the configuration of the serial port, and also the Fast Pot Scan and Keyboard Enable.

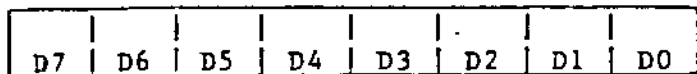

(Bits perform the functions shown below when true.)

D7 Force Break (force serial output to zero (space))*

D6
D5 \ Serial Port Mode Control (see mode chart on next page).
D4 /

D3 Two Tone (Serial output transmitted as two tone signal instead of logic true/false.)

D2 Fast Pot (Fast Pot Scan. The Pot Scan Counter completes its sequence in two TV line times instead of one frame time. The capacitor dump transistors are completely disabled.)

D1 Enable Key Scan (Enables Keyboard Scanning circuit)

D0 Enable Debounce (Enables Keyboard Debounce circuits)

D0-D1 (Both Zero) Initialize (State used for testing and initializing chip)**

*NOTE: When powered on, serial port output may stay low even if this bit is cleared. To get S. P. high (mark), send a byte out (recommend 00 or FF).

**NOTE: There is no original power on state. Pokey has no reset pin.



Serial Mode Control

Force Break

D7 | D6 | D5 | D4 | D3 | D2 | D1 | D0 |

SKCTL REGISTER

Pot scan and keyboard CTRL

Two Tone Control

Mode Control Bits

A = asynchronous

D6	D5	D4	Out Rate	Out Clock	In Rate	Bi-Dir Clock	Comments
0	0	0	ext	ext	ext	ext input	Trans. & Receive rates set by external clock. Also internal clock phase reset to zero.
0	0	1	ext	ext	chan 4 A	ext input	Trans. rate set by external clock. Receive asynch. (ch. 4) (CH3 and CH4)
0	1	0	chan 4	chan 4	chan 4	chan 4 output	Trans. & Receive rates set by Chan. 4. Chan. 4 output on Bi-Directional clock line.
0	1	1	CH4 A	CH4 A	CH4 A	input	Not Useful
1	0	0	chan 4	chan 4	ext	ext input	Trans. Rate Set by Chan. 4 Receive Rate set by External Clock.
1	0	1	CH4 A	CH4 A	CH4 A	input	Not Useful
1	1	0	Chan 2	Chan 2	Chan 2	Chan 4 Output	Trans. rate set by chan. 2 Recieve rate set by chan. 4 Chan. 4 out on Bi-Direct. Clock line.
1	1	1	Chan 2	Chan 2	Chan 4 A	Input not used	Trans. Rate set by Chan. 2. Re-ceive async. (chan 3&4) Bi-Dir. Clock not used (Tri-state condition)

Two tone (bit3) not useable in these modes

II.27



TITLE

POKEY CHIP

DRAWING NO.

COL2294

REV

B

SHEET

21

OF

SKSTAT (Serial Port-Keyboard Status) (0F): This address reads the status register giving information about the serial port and keyboard.

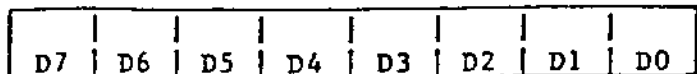

(Bits are normally true and provide the following information when zero.)

- D7 = 0 = Serial Data Input Frame Error
- D6 = 0 = Keyboard Over-run
- D5 = 0 = Serial Data Input Over-run
- D4 = Serial Input PAD SID Pad
- D3 = 0 = Shift Key Depressed
- D2 = 0 = Last Key is Still Depressed
- D1 = 0 = Serial Input Shift Register Busy
- D0 = 1 Not Used (Logic True)

D5 to D7 latches must be reset to 1 by SKRES.

(D5 and D6 are set to zero when new data and same bit of IRQST is zero.)

SKRES (Reset above Status Register) (0A): This write address resets bits 7, 6, and 5 of the Serial Port-Keyboard Status Register to 1.



SERIN (Serial Input Data) (0D): This address reads the 8 bit parallel holding register that is loaded when a full byte of serial input data has been received. This address is usually read in response to a serial data in interrupt (IRQ and bit 5 of IRQST). Also see IRQEN.

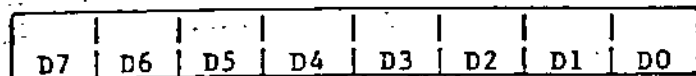

SEROUT (Serial Output Data) (0D): This address writes to the 8 bit parallel holding register that is transferred to the output serial shift register when a full byte of serial output data has been transmitted. This address is usually written in response to a serial data out interrupt (IRQ and bit 4 of IRQST).

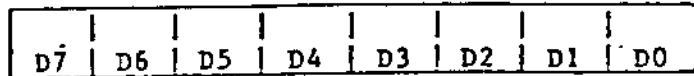

8.) IRQ INTERRUPTS: There are separate IRQ interrupt enable bits for each IRQ interrupt function (bits 0 through 7 of IRQEN). These bits are not initialized by power turn on, and must be initialized by the program before enabling the processor IRQ. The 8 types of IRQ interrupts are:

- D7 = BREAK KEY (depression of the break key)
- D6 = OTHER KEY (depression of any other key)
- D5 = SERIAL INPUT READY (Byte of serial data has been received and is ready to be read by the processor in SERIN register).
- D4 = SERIAL OUTPUT NEEDED (Byte of serial data is being transmitted and SEROUT is ready to be written to again by the processor).
- D3 = TRANSMISSION FINISHED (serial data transmission is finished. Output shift register is empty).
- D2 = TIMER # 4 (audio divider # 4 has counted down to zero)
- D1 = TIMER # 2 (audio divider # 2 has counted down to zero)
- D0 = TIMER # 1 (audio divider # 1 has counted down to zero)

These bits are enabled by bits 0 through 7 of IRQEN and identified by status bits 0 through 7 of IRQST.

The IRQEN register, like the NMIEN register, enables interrupts when its bits are 1 (logic true). The IRQST however (unlike the NMIST) has interrupt status bits that are normally logic true, and go to zero to indicate an interrupt request. The IRQST status bits are returned to logic true only by writing a zero into the corresponding IRQEN bit. This will disable the interrupt and simultaneously set the interrupt status bit to one. Bit 3 of IRQST is not a latch and does not get reset by interrupt disable. It is zero when the serial out is empty (out finished) and true when it is not.



TITLE

POKEY CHIP

DRAWING NO. C012294

REV B

SHEET 23

OF 4

IRQST (IRQ Interrupt Status) (0E): This address reads the data from the IRQ Interrupt Status Register.

0 = Interrupt

1 = No Interrupt

D7	D6	D5	D4	D3	D2	D1	D0
----	----	----	----	----	----	----	----

D7 = 0 Break Key Interrupt

D6 = 0 Other Key Interrupt

D5 = 0 Serial Input Data Ready Interrupt

D4 = 0 Serial Output Data Needed Interrupt

D3 = 0 Serial Output (Byte) Transmission Finished Interrupt *

D2 = 0 Timer 4 Interrupt

D1 = 0 Timer 2 Interrupt

D0 = 0 Timer 1 Interrupt

* - NOTE: Used for generation of 2 stop bits.

IRQEN (IRQ Interrupt Enable) (0E): This address writes data to the IRQ Interrupt Enable bits.

0 = disable, corresponding IRQST bit is set to 1

1 = enable

D7	D6	D5	D4	D3	D2	D1	D0
----	----	----	----	----	----	----	----

D7 Break Key Interrupt Enable

D6 Other Key Interrupt Enable

D5 Serial Input Data Ready Interrupt Enable

D4 Serial Output Data Needed Interrupt Enable

D3 Serial Out Transmission Finished Interrupt Enable

D2 Timer 4 Interrupt Enable

D1 Timer 2 Interrupt Enable

D0 Timer 1 Interrupt Enable



TITLE

POKEY CHIP

DRAWING NO.

CO12294

REV

B

SHEET 24

OF 4

9. ELECTRICAL PARAMETERS

A. General:

- 1.1 Storage Temperature..... -40°C to $+90^{\circ}\text{C}$
- 1.2 Ambient operating temperature..... 0°C to $+70^{\circ}\text{C}$
- 1.3 Failure rate less than 0.1% per 1000 hours
- 1.4 Maximum voltage range on any pin with respect to VSS
(Pin 1: substrate) without permanent damage to the chip.. -0.5V to $+9.0\text{V}$

B. D.C. and Operating Characteristics:

All voltages are referenced to VSS (pin 1). $T_A = 0^{\circ}\text{C}$ to 70°C .

	MIN.	TYP.	MAX.	UNIT
VCC (PIN 17)	+4.75		+5.25	VOLTS
ICC (PIN 17)			125.0	mA
<u>NORMAL INPUTS:</u>				
SID (PIN 24), $\overline{\text{CS0}}$ (PIN 30), CS1 (PIN 31), A0-A3 (PIN 36-PIN 33), R/W (PIN 32), $\overline{\text{KR1}}$ (PIN 25), $\overline{\text{KR2}}$ (PIN 16)				
V _{IH} INPUT HIGH VOLTAGE:	2.0		VCC	VOLTS
V _{IL} INPUT LOW VOLTAGE:	-0.5		+0.8	VOLTS
I _{LEAKAGE} INPUT LEAKAGE: VIN=7.0 VOLTS			10.0	μA
C _{PIN} PIN CAPACITANCE			7.0	pf
<u>DATA BUS I/O:</u>				
D0-D2 (PIN 38-PIN 40), D3-D7 (PIN 2-PIN 6)				
<u>INPUT:</u>				
V _{IH} INPUT HIGH VOLTAGE:	2.0		VCC	VOLTS
V _{IL} INPUT LOW VOLTAGE:	-0.5		+0.8	VOLTS
I _{LEAKAGE} INPUT LEAKAGE: OUTPUT TRI-STATE VIN=+7.0 VOLTS			10.0	μA
C _{PIN} PIN CAPACITANCE			15.0	pf
<u>OUTPUT:</u>				
V _{OH} OUTPUT HIGH VOLTAGE: I _{LOAD} =-0.1mA	2.4			VOLTS
V _{OL} OUTPUT LOW VOLTAGE: I _{LOAD} =+1.6mA			0.4	VOLTS
C _{LOAD} LOAD CAPACITANCE			130.0	pf



TITLE

POKEY CHIP

DRAWING NO.

CO12294

REV

B

SHEET

25

OF

B.) D.C. and Operating Characteristics: (Continued)

B) D.C. AND OPERATING CHARACTERISTICS: (CONT.)

	MIN.	TYP.	MAX.	UNIT
<u>BI-DIRECTIONAL I/O (SCHMITT TRIGGER INPUT):</u>				
ECLK (PIN 26), P0 (PIN 14), P1 (PIN 15), P2 (PIN 12), P3 (PIN 13), P4 (PIN 10), P5 (PIN 11), P6 (PIN 8), P7 (PIN 9)				
<u>INPUT:</u>				
V _{T+} POSITIVE-GOING THRESHOLD VOLTAGE:	1.9		2.6	VOLTS
V _{T-} NEGATIVE-GOING THRESHOLD VOLTAGE:	1.0		2.1	VOLTS
V _{HYS} HYSTERESIS:	0.3			VOLTS
I _{LEAKAGE} INPUT LEAKAGE: VIN=7.0 VOLTS PULL-DOWN IS TURNED OFF			10.0	uA
C _{PIN} PIN CAPACITANCE			7.0	pf
<u>OUTPUT:</u>				
V _{OL} OUTPUT LOW VOLTAGE: I LOAD=+1.6mA			0.4	VOLTS
C _{LOAD} LOAD CAPACITANCE			30.0	pf
<u>OUTPUT (OPEN DRAIN ONLY):</u>				
IRQ (PIN 29), SDD (PIN 28), OCLK (PIN 27)				
V _{OL} OUTPUT LOW VOLTAGE: I LOAD=+1.6mA			0.4	VOLTS
I _{LEAKAGE} INPUT LEAKAGE: VIN=7.0 VOLTS PULL-DOWN IS TURNED OFF			10.0	uA
C _{LOAD} LOAD CAPACITANCE			30.0	pf
<u>INPUT CLOCK :</u>				
BZ (PIN 7)				
V _{IH} INPUT HIGH VOLTAGE:	2.0		VCC	VOLTS
V _{IL} INPUT LOW VOLTAGE:	-0.5		+0.8	VOLTS
I _{LEAKAGE} INPUT LEAKAGE: VIN=7.0 VOLTS			10.0	uA
C _{PIN} PIN CAPACITANCE			14.0	pf
<u>KEYBOARD SCAN OUTPUT:</u>				
K0-K5 (PIN 23-PIN 18)				
V _{OH} OUTPUT HIGH VOLTAGE: I LOAD=-100.0 uA	2.4			VOLTS
V _{OH} OUTPUT HIGH VOLTAGE: I LOAD=-0.0 uA	4.3			VOLTS
V _{OL} OUTPUT LOW VOLTAGE: I LOAD=+1.6mA			0.4	VOLTS
C _{LOAD} LOAD CAPACITANCE			30.0	pf

D.C. and Operating Characteristics: (Continued)

	MIN.	TYP.	MAX.	UNIT
<u>AUDIO OUTPUT (MULTIPLE OPEN DRAIN OUTPUT):</u>				
AUD (PIN 37)				
V_{OL} OUTPUT LOW VOLTAGE: WITH $10K \pm 5\%$ OHM				
FULL UP TO 4.75 Vdc.				
$\frac{10 \text{ micron}}{10 \text{ micron}}$			4.2	VOLT
DEVICE ON ONLY.				
$\frac{20 \text{ micron}}{10 \text{ micron}}$			3.4	VOLT
DEVICE ON ONLY.				
$\frac{40 \text{ micron}}{10 \text{ micron}}$			2.1	VOLT
DEVICE ON ONLY.				
$\frac{80 \text{ micron}}{10 \text{ micron}}$			1.2	VOLT
DEVICE ON ONLY.				
V_{OH} OUTPUT HIGH VOLTAGE: WITH $10K \pm 5\%$ OHM				
FULL UP TO 4.75Vdc AND ALL FOUR DEVICES OFF				
	4.2			VOLT
C_{LOAD} LOAD CAPACITANCE			30.0	pf



TITLE

POKEY CHIP

DRAWING NO. COL2294

REV B

SHEET 27

OF 4

C.) Dynamic Operating Characteristics:

(VDD = 5V±5% TA = 0° to 70°C)

Parameter	Note	Signal Type	Symbol	MIN.	MAX.	UNI
<u>INPUT TIMING:</u>						
R/W SETUP TIME		BLE	T _{RWS}	130		nS
R/W HOLD TIME		ATE	T _{RWH}	30		nS
ADDRESS SETUP TIME		BLE	T _{ADS}	130		nS
ADDRESS HOLD TIME		ALE	T _{ADH}	30		nS
CHIP SELECT SETUP TIME		BLE	T _{CSS}	50		nS
CHIP SELECT HOLD TIME		ATE	T _{CSH}	30		nS
DATA SETUP TIME : D0-D7		BTE	T _{DSW}	130		nS
DATA HOLD TIME : D0-D7		ATE	T _{DHW}	10		nS
DATA SETUP TIME : $\overline{KR1}, \overline{KR2},$ P0-P7, SID, BCLK		BTE	T _{DS}	150		nS
<u>OUTPUT TIMING:</u>						
DATA SETUP TIME : D0-D7	2	BTE	T _{DSR}	50		nS
DATA HOLD TIME : D0-D7	2	ATE	T _{DHR}	20		nS
DATA DELAY TIME : \overline{IRQ}	1	ALE	T _{DD}		350	nS
DATA DELAY TIME : SOD, BCLK, OCLK	1	ATE	T _{DD}		350	nS
DATA DELAY TIME : AUD	3	ATE	T _{DD}		200	nS
DATA DELAY TIME : $\overline{K0-K5}$	1	ATE	T _{DD}		1.5	uS
DATA DELAY TIME : P0-P7	1	ALE	T _{DD}		1.5	uS

NOTES:

- 1) OUTPUT LOAD AT 30pF + 1 TTL
- 2) OUTPUT LOAD AT 130pF + 1 TTL
- 3) OUTPUT LOAD AT 30pF



D.) Write I/O Timing:

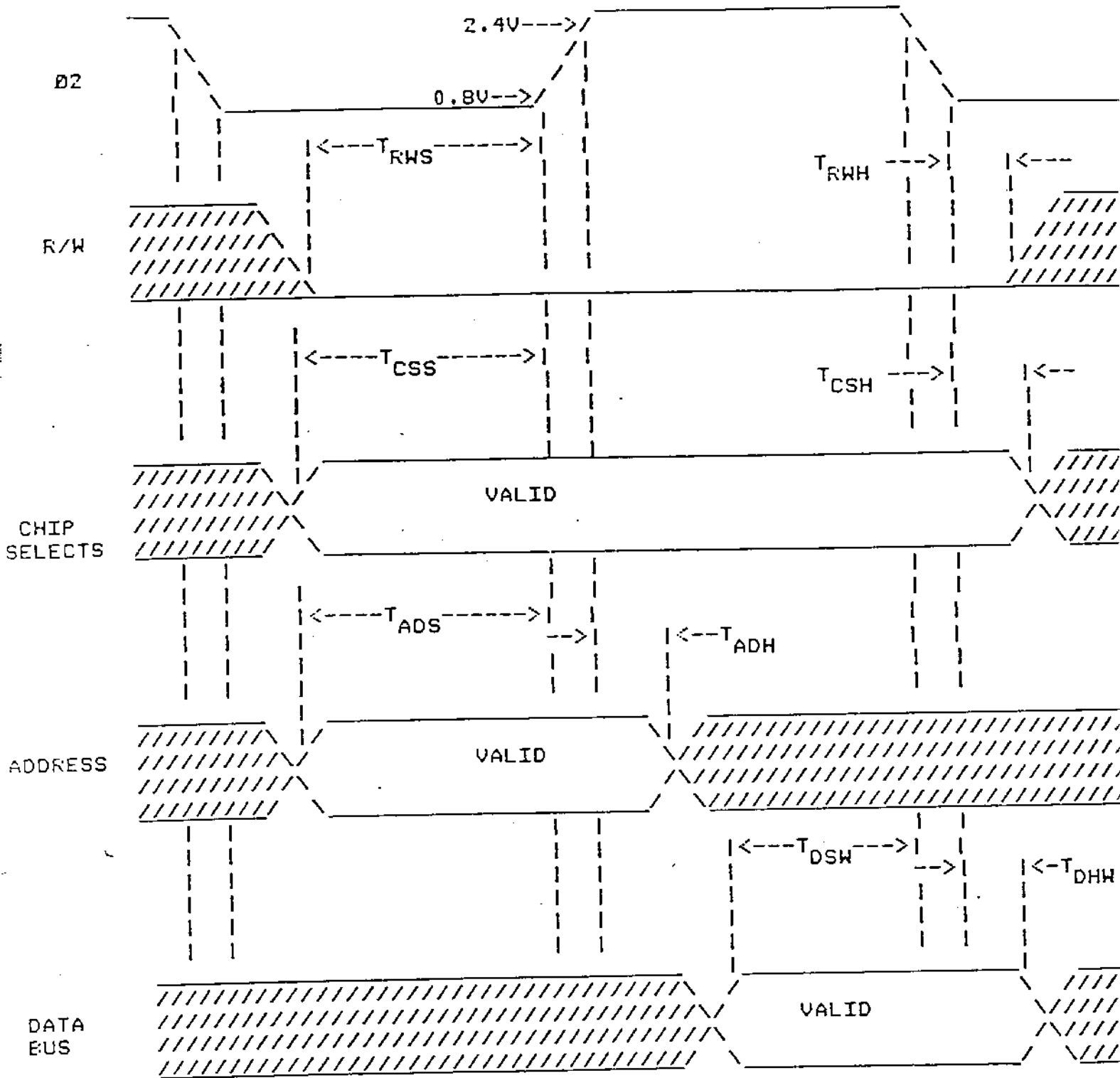

NOTE: ADDRESSES ARE CLOCKED IN ON THE RAISING EDGE OF $\phi 2$.



E.) Read I/O Timing:

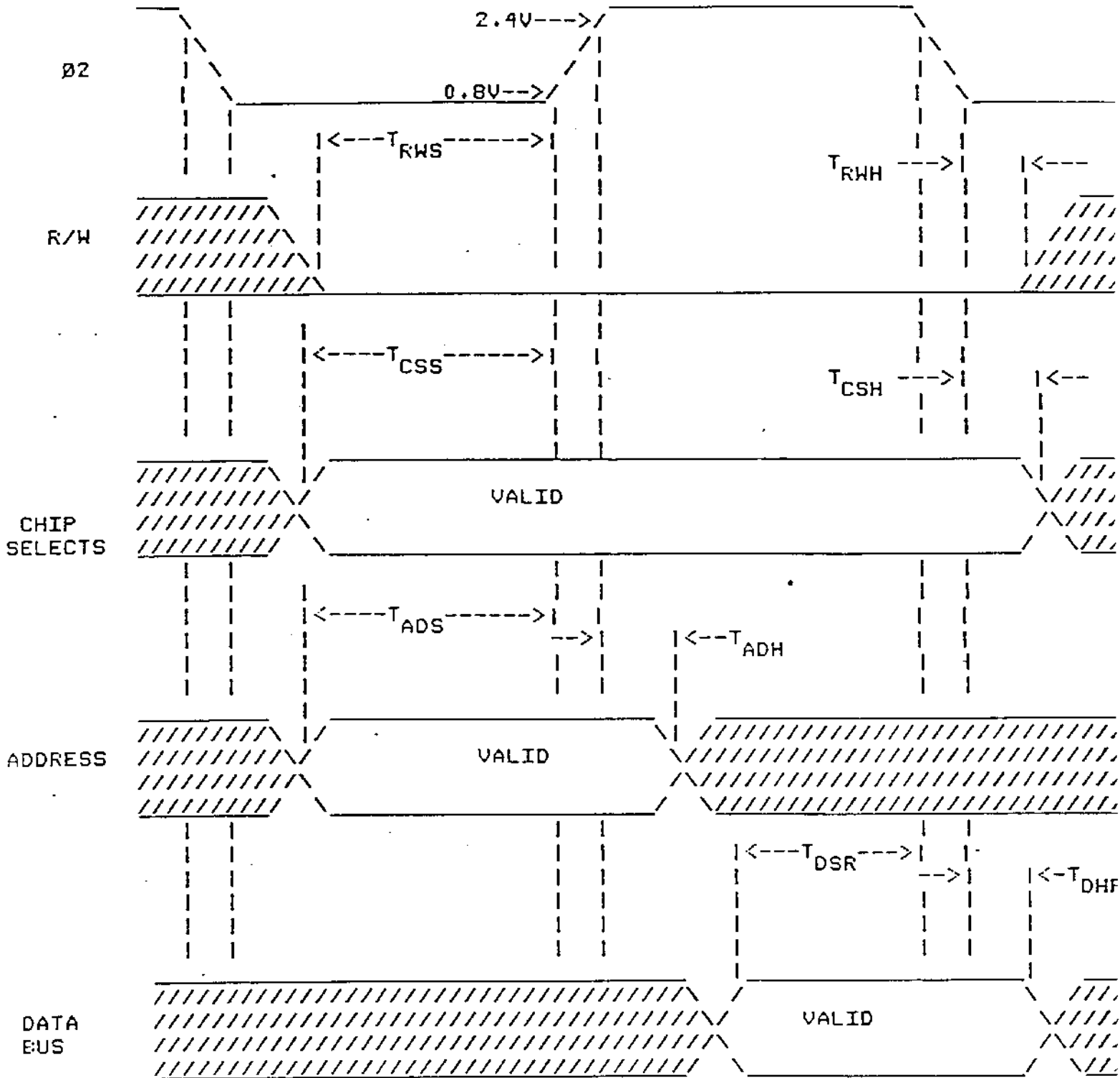

NOTE: ADDRESSES ARE CLOCKED IN ON THE RAISING EDGE OF Ø2.

F. I/O Timing:

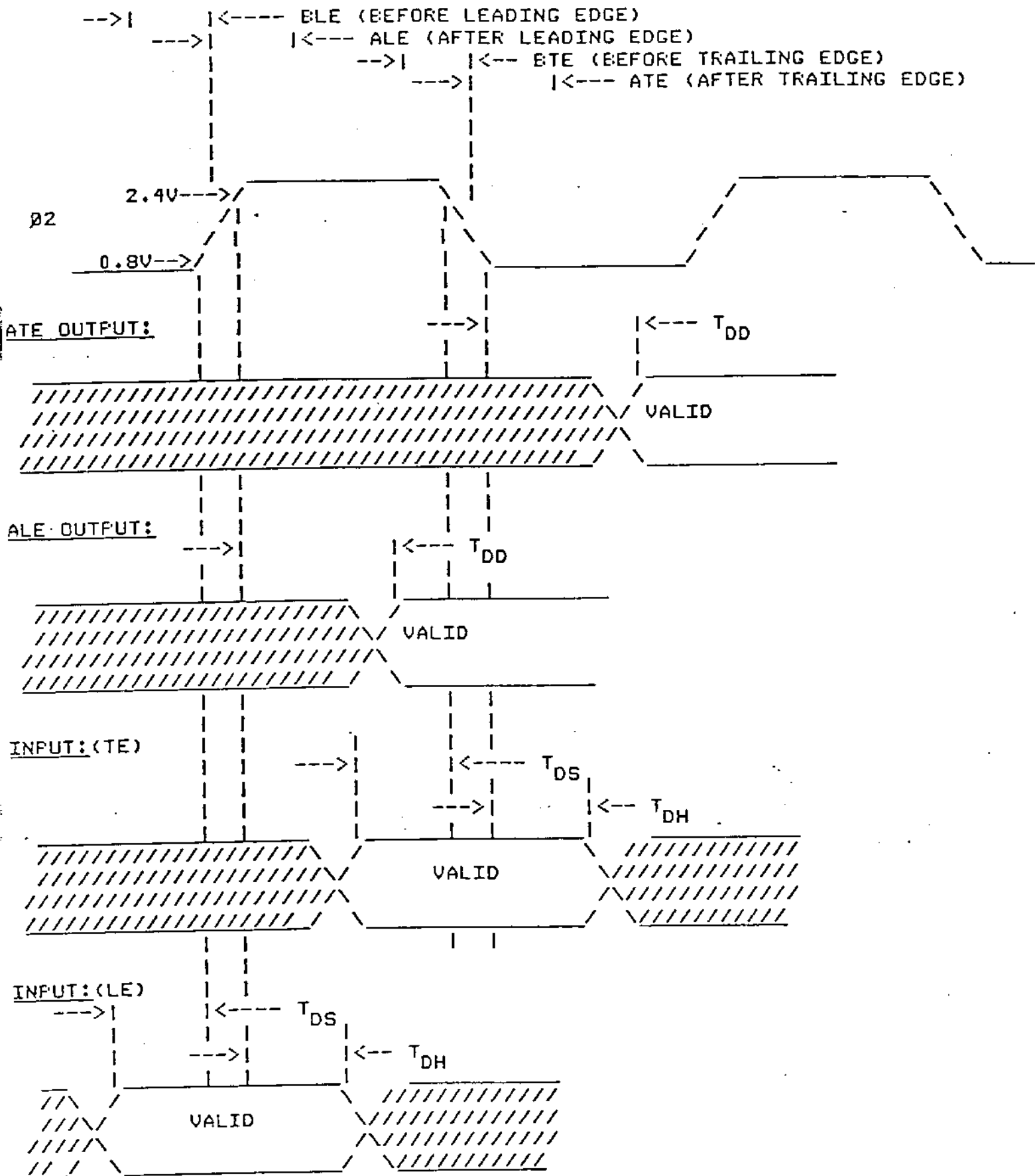

TITLE POKEY CHIP

DRAWING NO. COL2294

REV B SHEET 31 OF

POKEY ADDRESS TABLE:

ADDRESS	WRITE		READ	
	Name	Description	Name	Description
0	AUDF1	Audio Channel 1 Frequency	POT0	Read the value of each pot
1	AUDC1	Audio Channel 1 Control	POT1	
2	AUDF2	Audio Channel 2 Frequency	POT2	
3	AUDC2	Audio Channel 2 Control	POT3	
4	AUDF3	Audio Channel 3 Frequency	POT4	
5	AUDC3	Audio Channel 3 Control	POT5	
6	AUDF4	Audio Channel 4 Frequency	POT6	
7	AUDC4	Audio Channel 4 Control	POT7	
8	AUDCTL	Audio Control	ALLPOT	Read 8 line pot port state
9	STIMER	Start timers	KBCODE	Keyboard code
A	SKRES	Reset Status (SKSTAT)	RANDOM	Random number generator
B	POTGO	Start pot scan sequence		
C				
D	SEROUT	Serial port output register	SERIN	Serial port input register
E	IRQEN	IRQ Interrupt enable	IRQST	IRQ Interrupt status register
F	SKCTLS	Serial port 4 key control	SKSTAT	Serial port 4 key status register



TITLE

POKEY CHIP

DRAWING NO. COL2294

REV B

SHEET 32

OF

POKEY PIN LIST:

<u>PACKAGE PIN</u>	<u>NAME</u>	<u>FUNCTION</u>	
1	VSS	Ground	I
2	D3	Data Bus	I/O
3	D4	Data Bus	I/O
4	D5	Data Bus	I/O
5	D6	Data Bus	I/O
6	D7	Data Bus	I/O
7	O2	Phase 2 Clock	I
8	P6	Pot Scan	I
9	P7	Pot Scan	I
10	P4	Pot Scan	I
11	P5	Pot Scan	I
12	P2	Pot Scan	I
13	P3	Pot Scan	I
14	P0	Pot Scan	I
15	P1	Pot Scan	I
16	/KR2	Keyboard Scan	I
17	VDD	5 V Power	I
18	/K5	Keyboard Scan	O
19	/K4	Keyboard Scan	O
20	/K3	Keyboard Scan	O
21	/K2	Keyboard Scan	O
22	/K1	Keyboard Scan	O
23	/K0	Keyboard Scan	O
24	SID	Serial Input Data	I
25	/KR1	Keyboard Scan	I
26	BCLK	Bidirection Clock	I/O
27	OCLK	Serial Output Clock	O
28	SOD	Serial Output Data	O
29	/IRQ	Interrupt Request	O
30	/CS0	Chip Select	I
31	CS1	Chip Select	I
32	R/W	Read/Write Control	I
33	A3	Address Bus	I
34	A2	Address Bus	I
35	A1	Address Bus	I
36	A0	Address Bus	I
37	AUDIO	Audio Out	O
38	DO	Data Bus	I/O
39	D1	Data Bus	I/O
40	D2	Data Bus	I/O



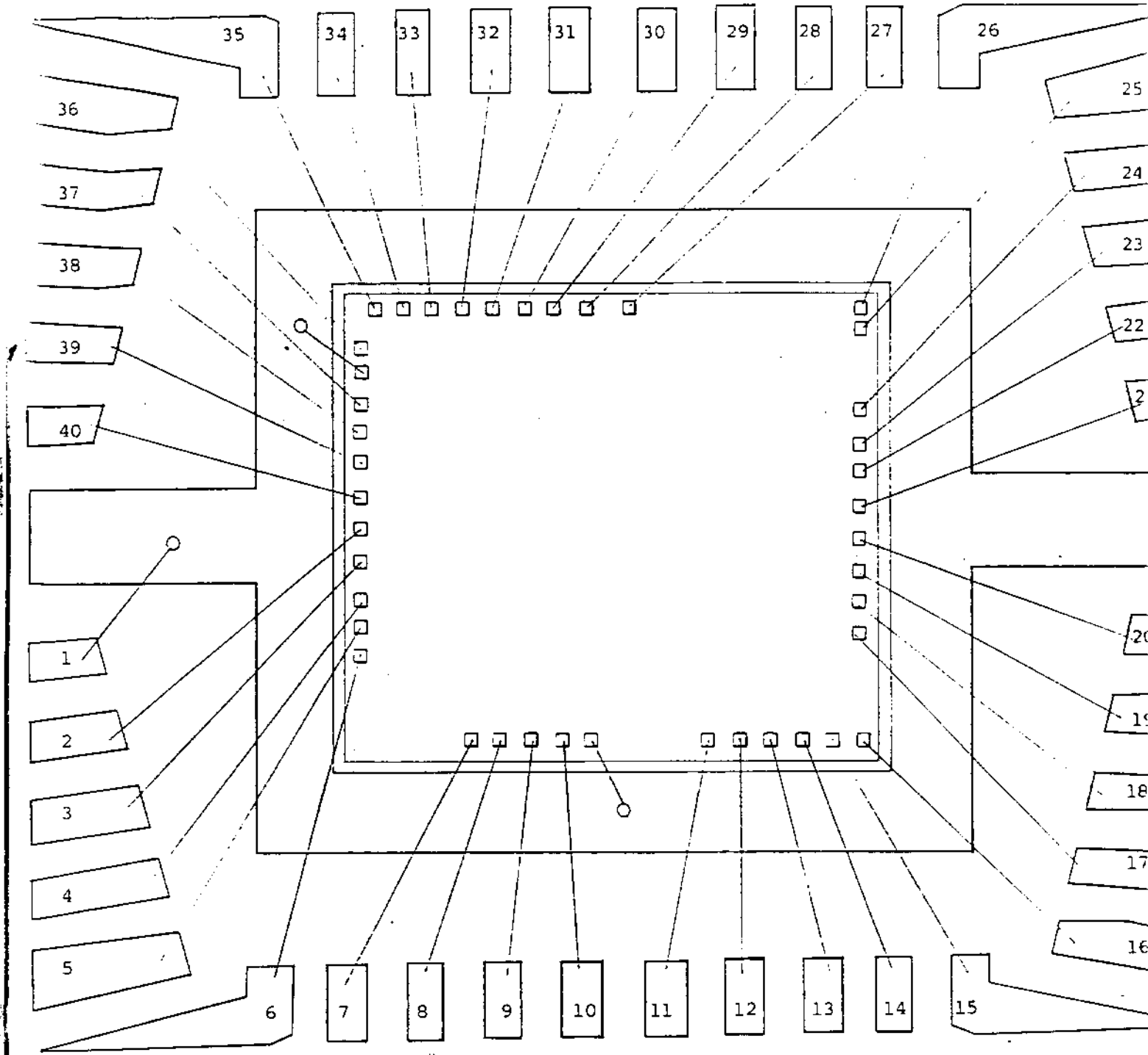

SCALE: 20:1

PACKAGE 204,000-3

DIE SIZE: 179 mils X 159 mils

WIRE BOND: 1.1 mil gold T.C.

DIE ATTACH CAVITY: 210 X 230

COMMENT :

Six Micron Design Rules.

POKEY BONDING DIAGRAM
(Figure 11)

sheet 34 of 41

SYM	REVISIONS	DATE	APPROVED
B	SEE SHEET 1		



POKEY CHIP

DRAWN BY	ENGINEER, MDR.	MATERIAL
CHECKED	QUAL. ASSURANCE	DRAWING NO
ENGINEER	MFG ENGINEER	C012994

REV	REVISION DESCRIPTION	DATE	APPROVED
1
2
3
4
5
6
7
8
9
10

Worst Case: Chip Nbr Selected
 ADDR XR: $13 \times (90\mu + 600\mu) = 9\text{ms}$
 ADDR XW: $15 \times (90\mu + 416\mu) = 7.6\text{ms}$
 $P_i: 4 \times 10^5 = 4.2\text{ms}$
 $R/W, CS1, CS2 = 1.6\text{ms}$
 Data I/O: $8 \times 4 = 31.2\text{ms}$

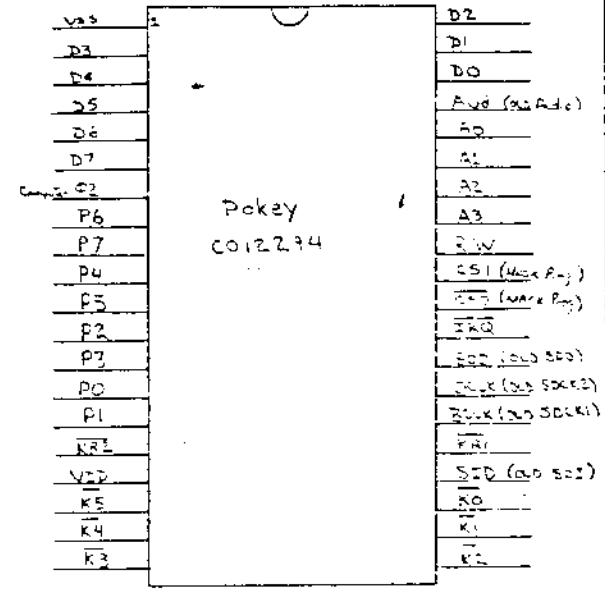
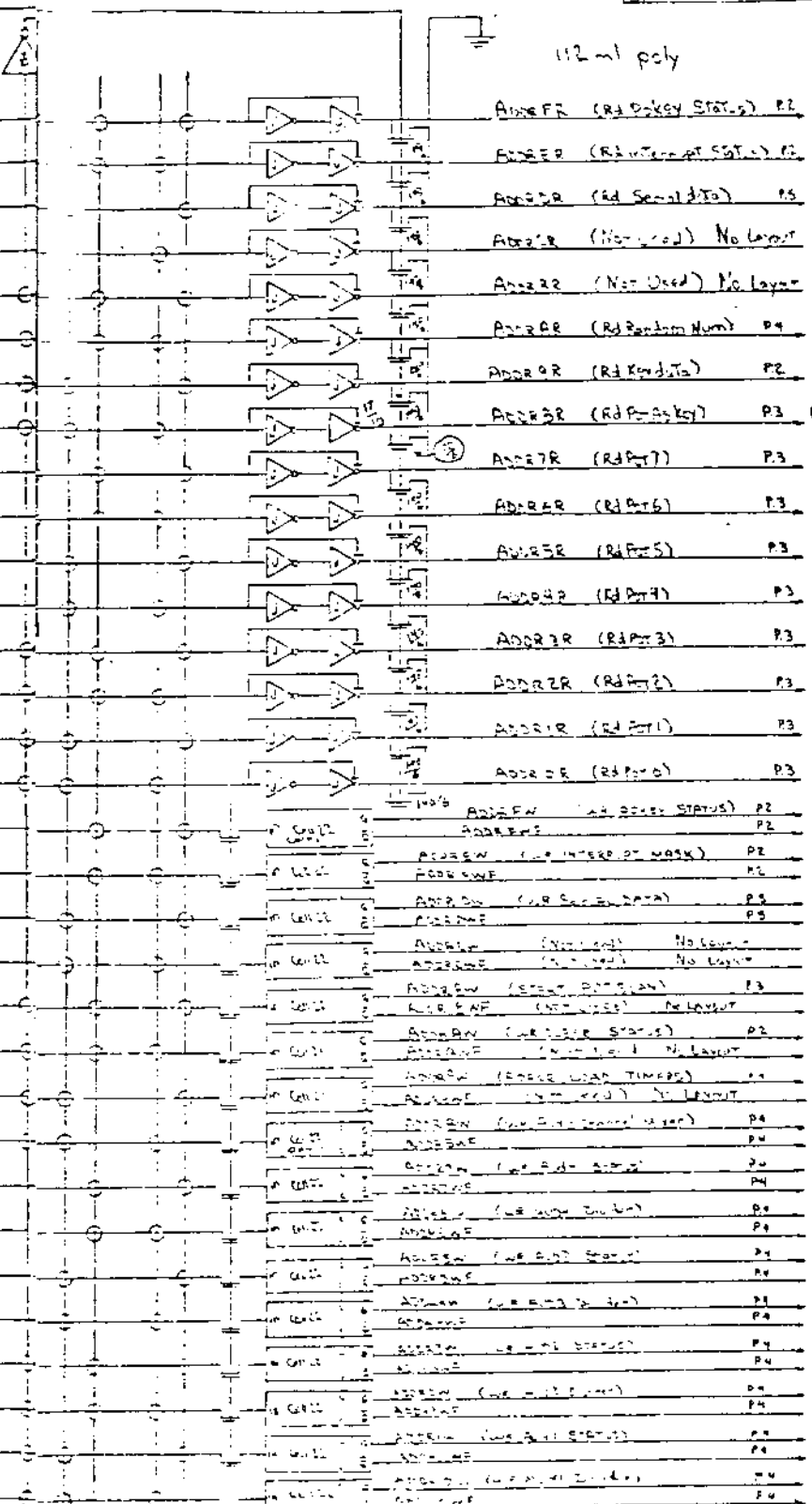

D
C
B

CONFIDENTIAL

OUTSTANDING ECNs	

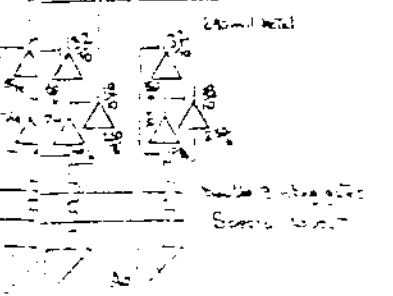

UNLESS OTHERWISE SPECIFIED DIMENSIONS ARE IN INCHES TOLERANCES ON ANGLES ±1° DEC 1973 REV. BY: [Signature]	DO NOT SCALE DRAWING	Atari Inc. 12855 Borregat Avenue Sunnyvale, Calif. 94086
	DRAWN BY: [Signature] DATE: [Date]	
MATERIAL: [Text] Chip Total 26.3 mg 700 mJ	EMPLOYEE: [Signature]	TITLE: [Text]
PROJECT ENGINEER: [Signature]	PROJECT ENGINEER: [Signature]	DATE: [Date]
P/C INCHES: [Text]	P/C INCHES: [Text]	PART NUMBER: [Text]

A

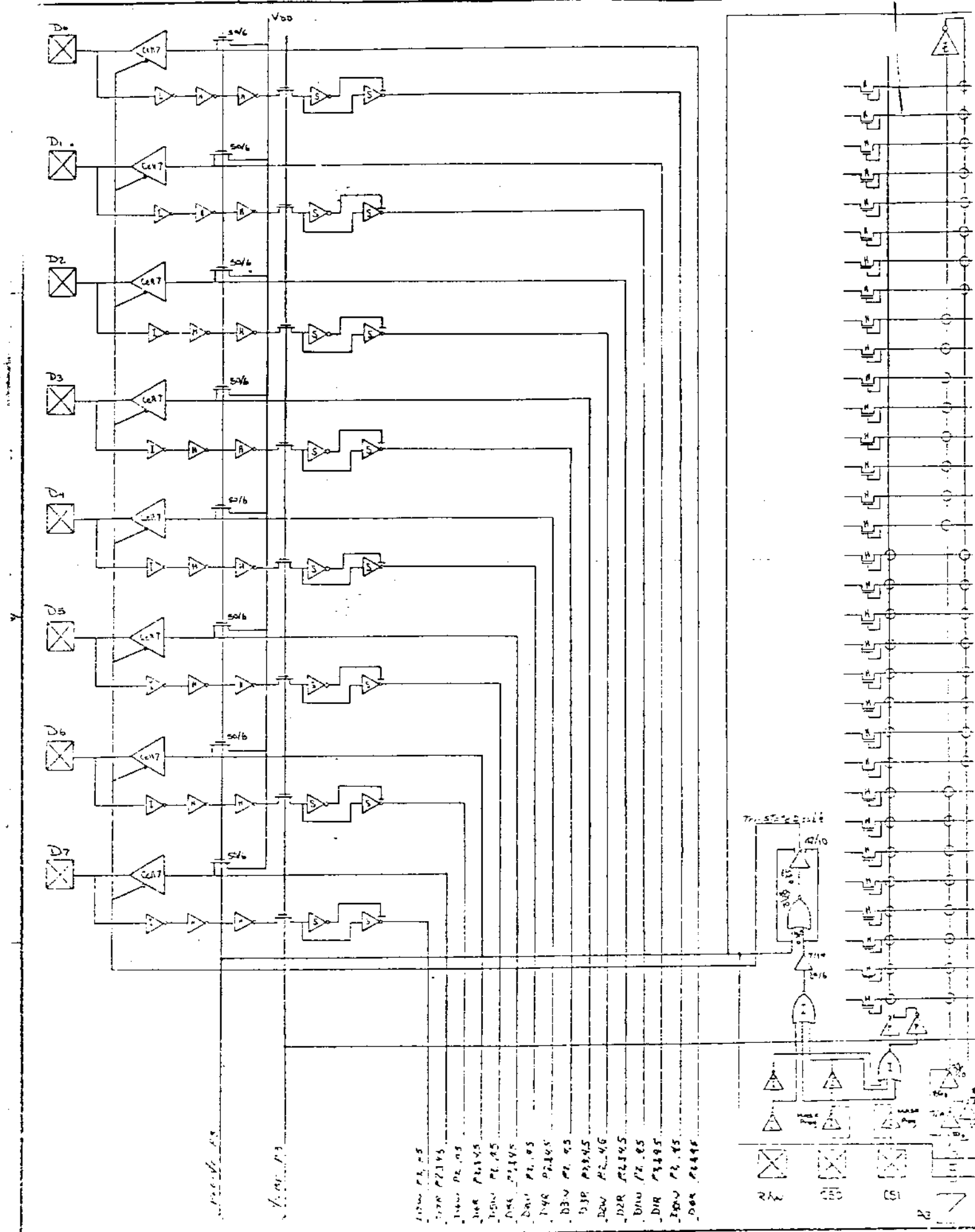

- 1000 P2.05
- 1000 P2.10
- 1000 P2.15
- 1000 P2.20
- 1000 P2.25
- 1000 P2.30
- 1000 P2.35
- 1000 P2.40
- 1000 P2.45
- 1000 P2.50
- 1000 P2.55
- 1000 P2.60
- 1000 P2.65
- 1000 P2.70
- 1000 P2.75
- 1000 P2.80
- 1000 P2.85
- 1000 P2.90
- 1000 P2.95

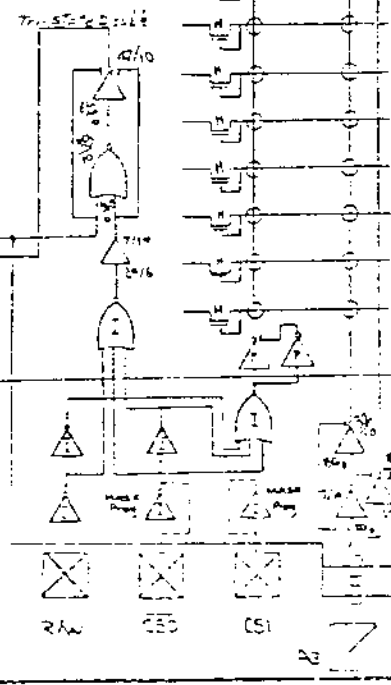

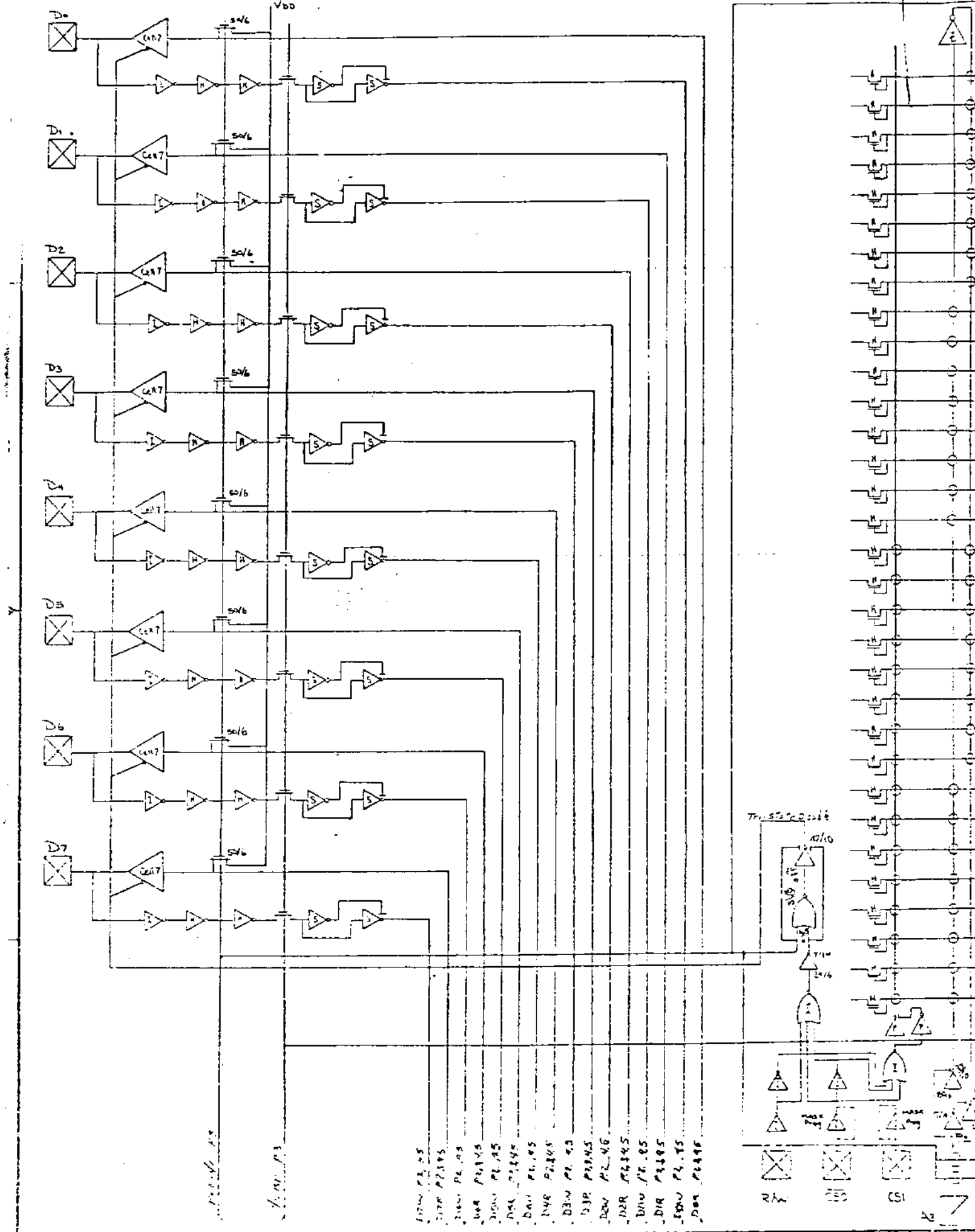

2

7

6

5

- D1 D1 P2, P5
- D2 D2 P1, P5
- D3 D3 P1, P5
- D4 D4 P1, P5
- D5 D5 P1, P5
- D6 D6 P1, P5
- D7 D7 P1, P5
- D8 D8 P1, P5
- D9 D9 P1, P5
- D10 D10 P1, P5
- D11 D11 P1, P5
- D12 D12 P1, P5
- D13 D13 P1, P5
- D14 D14 P1, P5
- D15 D15 P1, P5
- D16 D16 P1, P5
- D17 D17 P1, P5
- D18 D18 P1, P5
- D19 D19 P1, P5
- D20 D20 P1, P5
- D21 D21 P1, P5
- D22 D22 P1, P5
- D23 D23 P1, P5
- D24 D24 P1, P5
- D25 D25 P1, P5
- D26 D26 P1, P5
- D27 D27 P1, P5
- D28 D28 P1, P5
- D29 D29 P1, P5
- D30 D30 P1, P5
- D31 D31 P1, P5
- D32 D32 P1, P5
- D33 D33 P1, P5
- D34 D34 P1, P5
- D35 D35 P1, P5
- D36 D36 P1, P5
- D37 D37 P1, P5
- D38 D38 P1, P5
- D39 D39 P1, P5
- D40 D40 P1, P5
- D41 D41 P1, P5
- D42 D42 P1, P5
- D43 D43 P1, P5
- D44 D44 P1, P5
- D45 D45 P1, P5
- D46 D46 P1, P5
- D47 D47 P1, P5
- D48 D48 P1, P5
- D49 D49 P1, P5
- D50 D50 P1, P5
- D51 D51 P1, P5
- D52 D52 P1, P5
- D53 D53 P1, P5
- D54 D54 P1, P5
- D55 D55 P1, P5
- D56 D56 P1, P5
- D57 D57 P1, P5
- D58 D58 P1, P5
- D59 D59 P1, P5
- D60 D60 P1, P5
- D61 D61 P1, P5
- D62 D62 P1, P5
- D63 D63 P1, P5
- D64 D64 P1, P5
- D65 D65 P1, P5
- D66 D66 P1, P5
- D67 D67 P1, P5
- D68 D68 P1, P5
- D69 D69 P1, P5
- D70 D70 P1, P5
- D71 D71 P1, P5
- D72 D72 P1, P5
- D73 D73 P1, P5
- D74 D74 P1, P5
- D75 D75 P1, P5
- D76 D76 P1, P5
- D77 D77 P1, P5
- D78 D78 P1, P5
- D79 D79 P1, P5
- D80 D80 P1, P5
- D81 D81 P1, P5
- D82 D82 P1, P5
- D83 D83 P1, P5
- D84 D84 P1, P5
- D85 D85 P1, P5
- D86 D86 P1, P5
- D87 D87 P1, P5
- D88 D88 P1, P5
- D89 D89 P1, P5
- D90 D90 P1, P5
- D91 D91 P1, P5
- D92 D92 P1, P5
- D93 D93 P1, P5
- D94 D94 P1, P5
- D95 D95 P1, P5
- D96 D96 P1, P5
- D97 D97 P1, P5
- D98 D98 P1, P5
- D99 D99 P1, P5
- D100 D100 P1, P5

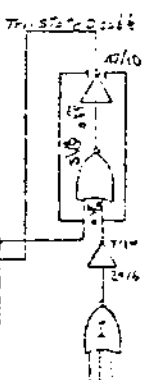

RA

RB

CS1

CS2

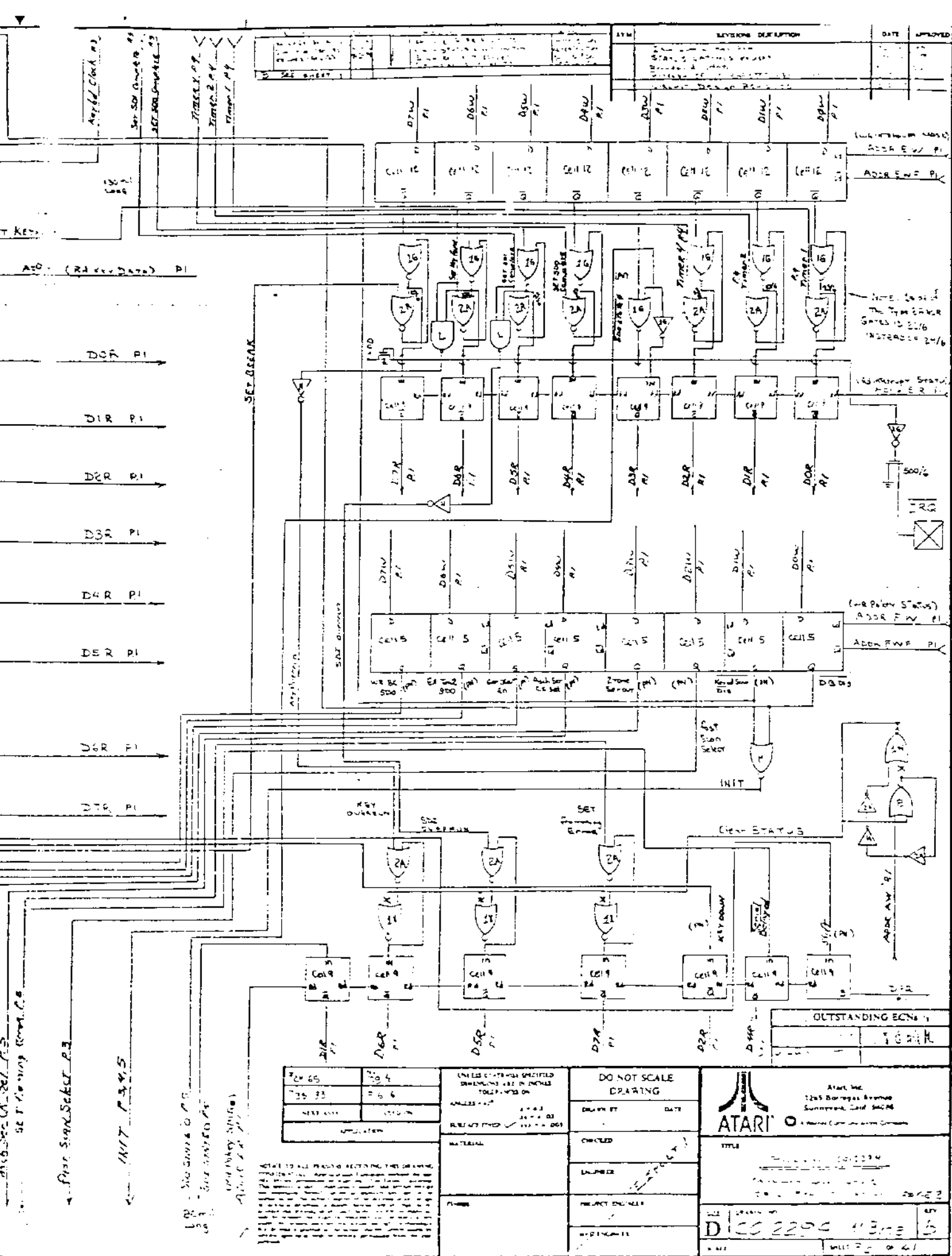

CO12294 36 B

C

B

A

24 05	25 04
25 33	26 06
NEXT ASSY	27 09

UNLESS OTHERWISE SPECIFIED
DIMENSIONS ARE IN INCHES
TOLERANCES ARE:

FINISHES: 2-4-2
2-4-4-2
2-4-4-2

MATERIAL: 100%
DATE: 11-1-83

DO NOT SCALE
DRAWING

DRAWN BY: DATE:

CHECKED:

INCHES:

FRONT OR REAR:

BY: DATE:

ATARI

Atari, Inc.
1245 Borregas Avenue
Sunnyvale, Calif. 94086

A Division of Commodore International

OUTSTANDING ECNs:

NO.	DATE

CO12294 11/1/83

DATE: 11-1-83

BY: [Signature]

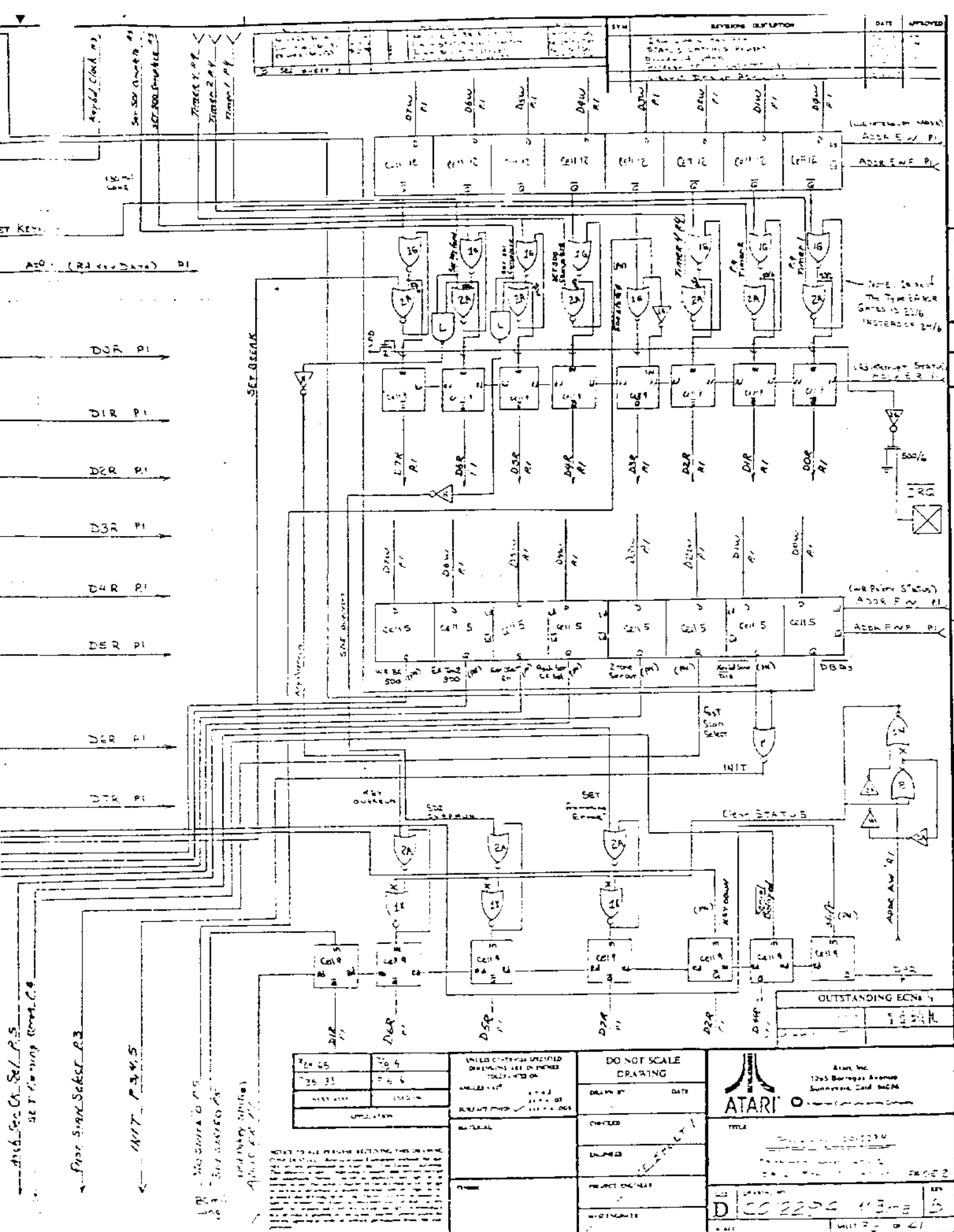

D
 C
 B
 A

CO12294

36 B

C

B

A

REV 05	REV 04
REV 03	REV 02
REV 01	REV 00

UNLESS OTHERWISE SPECIFIED
 DIMENSIONS ARE IN INCHES
 TOLERANCES ARE:

DO NOT SCALE
 DRAWING

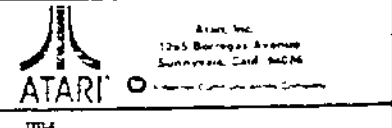

APPROVED: _____
 DATE: _____

CHECKED: _____
 DESIGNED: _____
 PROJECT ENGINEER: _____
 WORKING DRAWING: _____

DRAWN BY: _____
 DATE: _____

TITLE: _____
 PROJECT NO.: _____
 SHEET NO.: _____
 TOTAL SHEETS: _____

INIT P 3 4 5
 SET KEY...
 SET BREAK...
 SAFE OPERATION...

DOR PI
 DIR PI
 DCR PI
 DSR PI
 DLR PI
 DMR PI
 DOR PI
 DIR PI
 DCR PI
 DSR PI
 DLR PI
 DMR PI

SYN	REV	DATE	BY
1	1	10/10/77	...
2	1	10/10/77	...
3	1	10/10/77	...

Clock generation
Default: Page 7

Computer ϕ_2

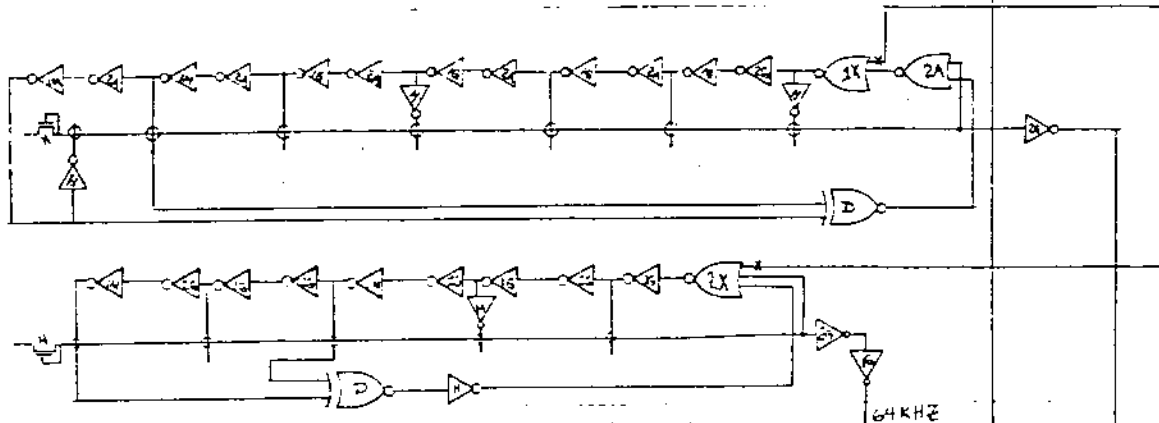

64KHz

LSYNC

CONFIDENTIAL

OUTSTANDING ECN#	

DATE	BY	DATE	BY
10/10/77	...	10/10/77	...
10/10/77	...	10/10/77	...
10/10/77	...	10/10/77	...

UNLESS OTHERWISE SPECIFIED
DIMENSIONS ARE IN INCHES
TOLERANCES ON

DO NOT SCALE
DRAWING

DESIGNED BY: [Signature]
DATE: 10/10/77
CHECKED BY: [Signature]
DATE: 10/10/77
PROJECT ENGINEER: [Signature]
DATE: 10/10/77
MILL DRAWING

ATARI, Inc.
1285 Burrage Avenue
Sunnyvale, Calif 94088

TITLE: [Blank]
DATE: 10/10/77
PAGE 3

REV	DATE
3	10/10/77
2	10/10/77
1	10/10/77

Fast Scan Select

PRC Per Clock

ADDA Bw P1
(3.725 + 400.000)

Number Clock P1

Number Select P1

PW1 P2

Number P2

CO12294

37

B

C

B

A

4

3

2

1

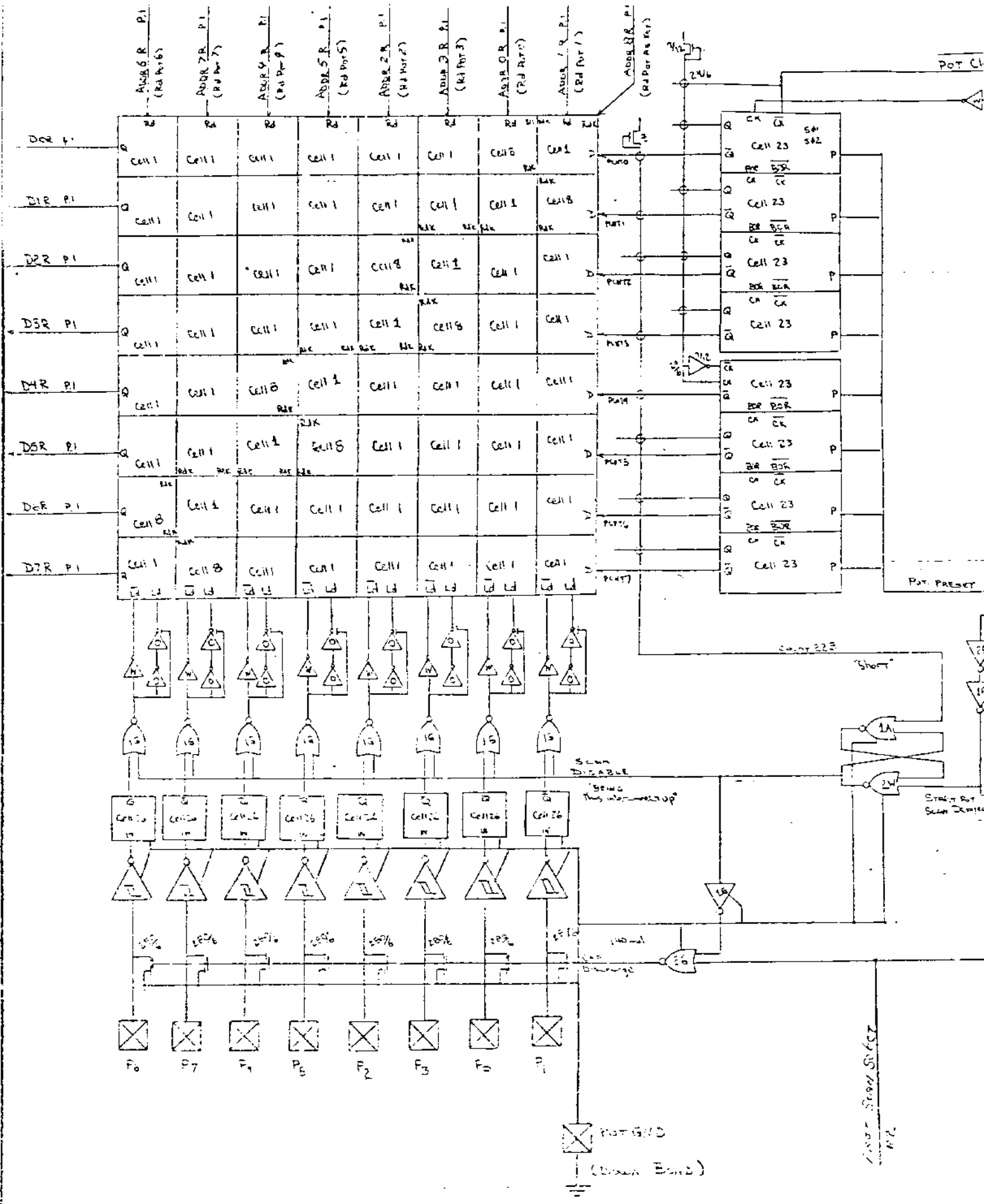

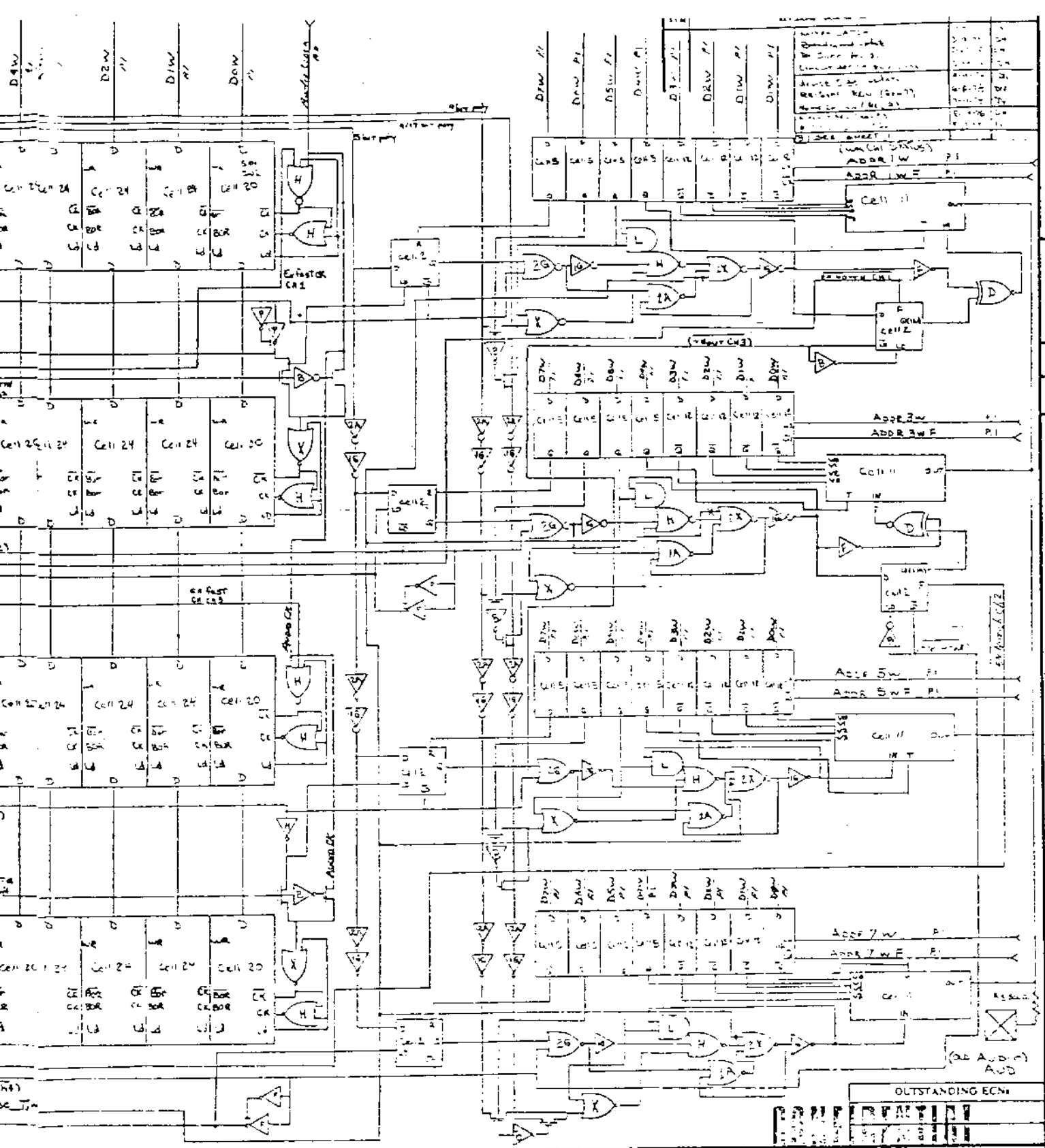

D
 C
 B
 A

CO12294 38 B

35 74	74 124
74 10	74 22
74 11	74 23
74 12	74 24
74 13	74 25
74 14	74 26
74 15	74 27
74 16	74 28
74 17	74 29
74 18	74 30
74 19	74 31
74 20	74 32
74 21	74 33
74 22	74 34
74 23	74 35
74 24	74 36
74 25	74 37
74 26	74 38
74 27	74 39
74 28	74 40
74 29	74 41
74 30	74 42
74 31	74 43
74 32	74 44
74 33	74 45
74 34	74 46
74 35	74 47
74 36	74 48
74 37	74 49
74 38	74 50
74 39	74 51
74 40	74 52
74 41	74 53
74 42	74 54
74 43	74 55
74 44	74 56
74 45	74 57
74 46	74 58
74 47	74 59
74 48	74 60
74 49	74 61
74 50	74 62
74 51	74 63
74 52	74 64
74 53	74 65
74 54	74 66
74 55	74 67
74 56	74 68
74 57	74 69
74 58	74 70
74 59	74 71
74 60	74 72
74 61	74 73
74 62	74 74
74 63	74 75
74 64	74 76
74 65	74 77
74 66	74 78
74 67	74 79
74 68	74 80
74 69	74 81
74 70	74 82
74 71	74 83
74 72	74 84
74 73	74 85
74 74	74 86
74 75	74 87
74 76	74 88
74 77	74 89
74 78	74 90
74 79	74 91
74 80	74 92
74 81	74 93
74 82	74 94
74 83	74 95
74 84	74 96
74 85	74 97
74 86	74 98
74 87	74 99

UNLESS OTHERWISE SPECIFIED
 DIMENSIONS ARE IN INCHES
 TOLERANCES ON
 ANGLES ± 1°
 SURFACE FINISH
 MATERIAL
 FINISH

DO NOT SCALE DRAWING
 DRAWN BY _____ DATE _____
 CHECKED _____
 ENGINEER _____
 PROJECT NUMBER _____
 FILE NUMBER _____

OUTSTANDING ECNs: _____
ATARI
 Atari, Inc.
 1265 Borregas Avenue
 Sunnyvale, Calif. 94086
 TITLE: _____
 PART NUMBER: _____
 D CO12294 38 B

4
 3
 2
 1

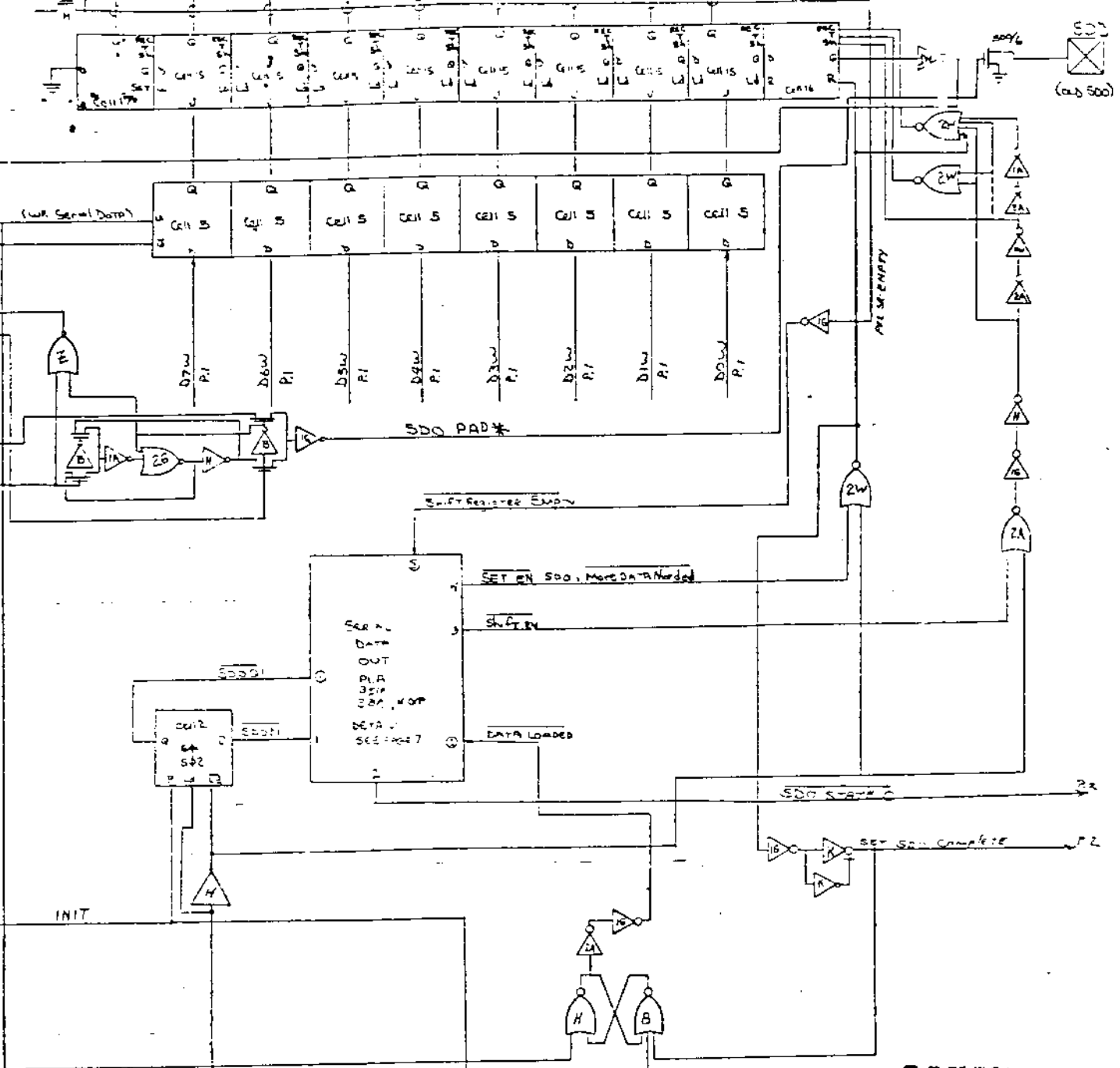

D
 C
 B
 A
 4
 3
 2
 1

DRAWING NO. CO12294
 SHEET 39
 OF 41

CONFIDENTIAL

OUTSTANDING ECNs	

REV 63	EA 36	UNLESS OTHERWISE SPECIFIED DIMENSIONS ARE IN INCHES TOLERANCES ON ANGLES ± 1° SURFACE FINISH UNLESS OTHERWISE SPECIFIED FINISH	DO NOT SCALE DRAWING	 ATARI INC. 1285 BARRAGE AVENUE SUNNYVALE, CALIF. 94088 COMMUNICATIONS DEPARTMENT
DATE 10/23/81	BY 10/23/81		DRAWN BY DATE	
NEXT ASSY 10/23/81	10/23/81		CHECKED DATE	
DESCRIPTION		PROJECT DRAWING	DESIGNER	TITLE
NOTICE TO ALL PERSONS RECEIVING THIS DRAWING: THIS DRAWING IS THE PROPERTY OF ATARI INC. AND IS TO BE USED ONLY FOR THE PROJECT AND FOR WHICH IT WAS PREPARED. IT IS NOT TO BE REPRODUCED, COPIED, OR TRANSMITTED IN ANY FORM OR BY ANY MEANS, ELECTRONIC OR MECHANICAL, INCLUDING PHOTOCOPYING, RECORDING, OR BY ANY INFORMATION STORAGE AND RETRIEVAL SYSTEM, WITHOUT THE WRITTEN PERMISSION OF ATARI INC.		PROJECT ENGINEER	DATE	DRAWING NO.
		DATE	DRAWING NO.	SHEET

A

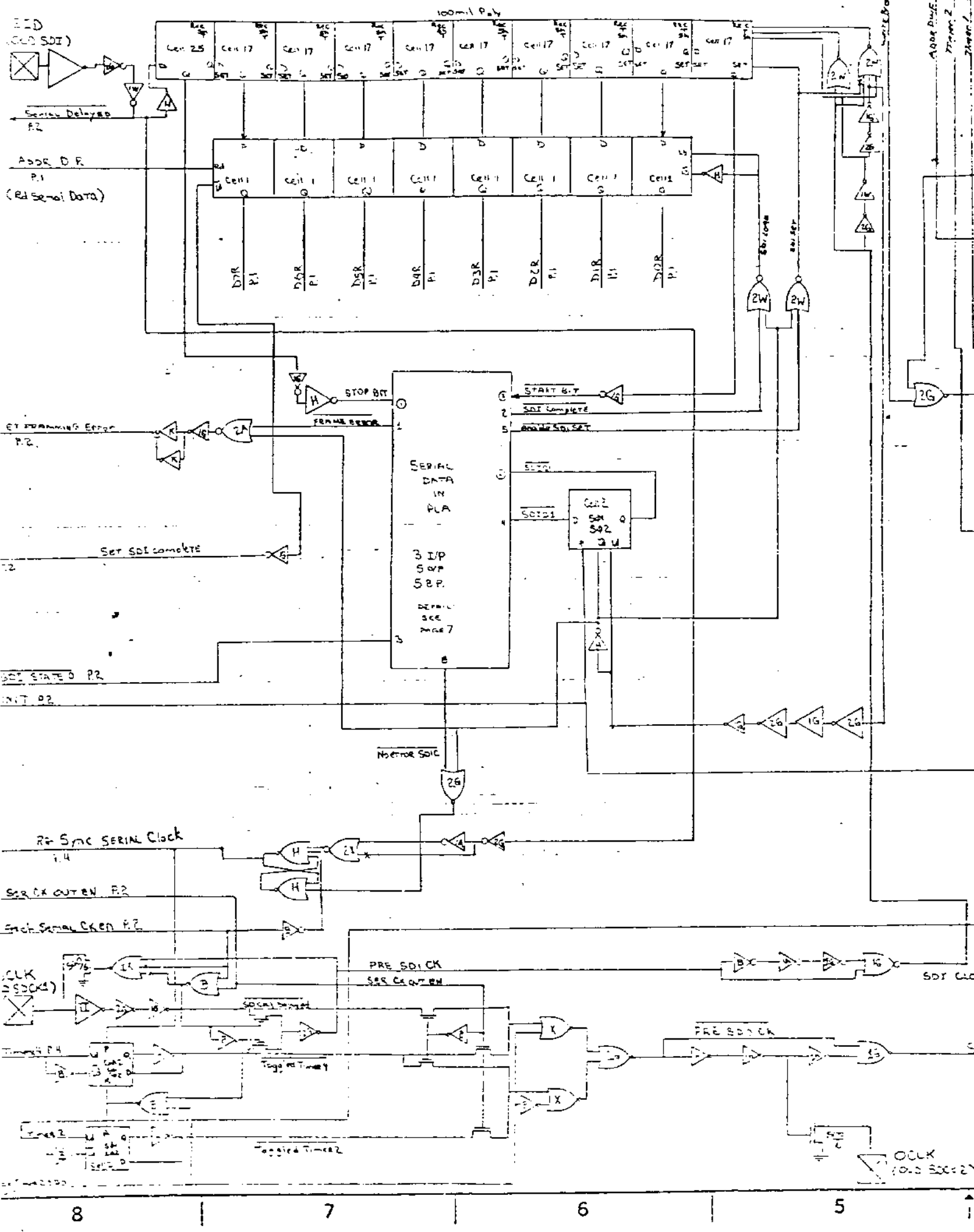

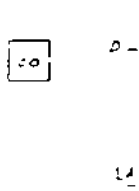
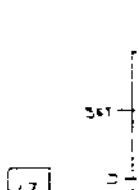
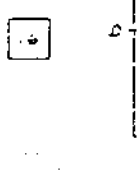
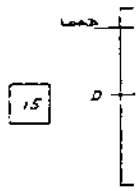
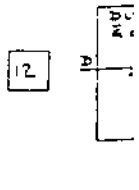
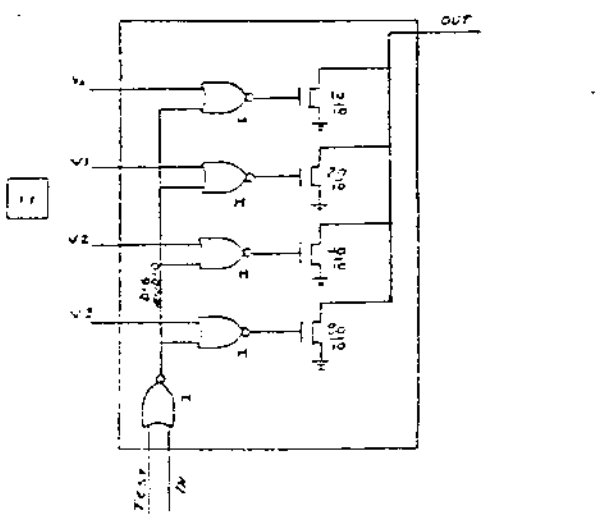
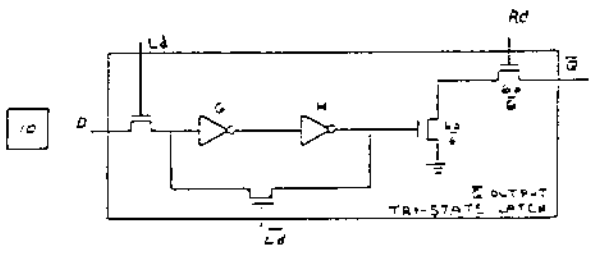
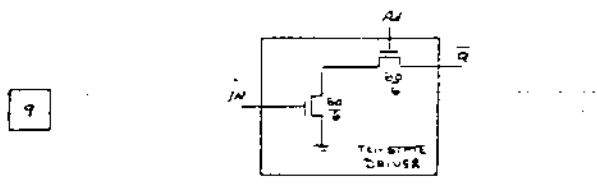
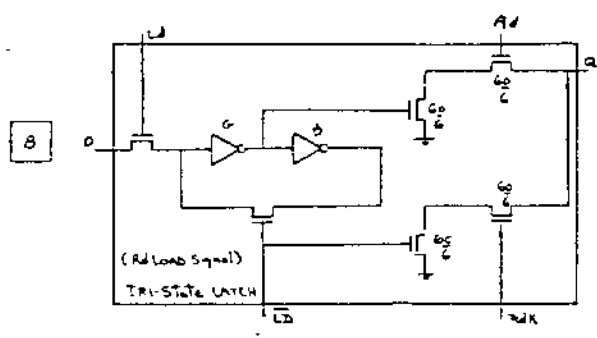
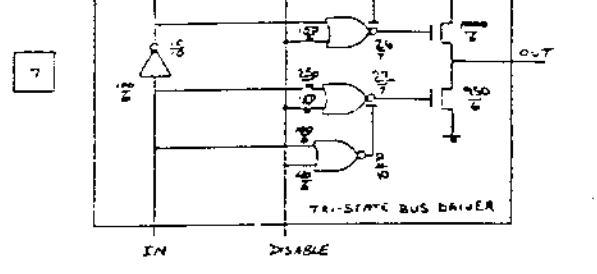
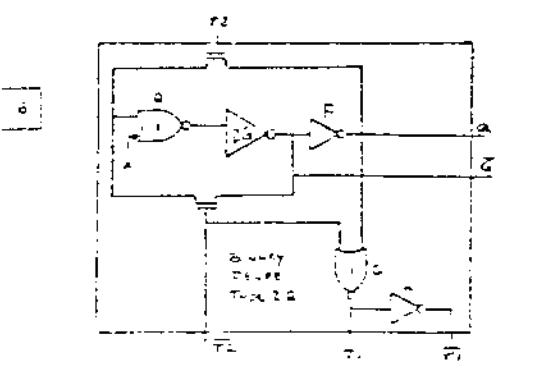
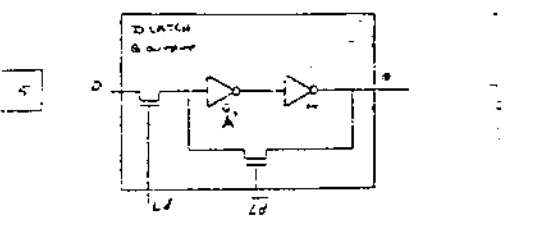
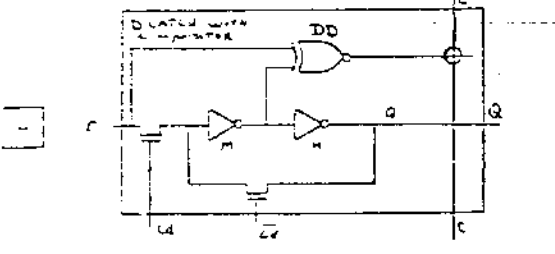
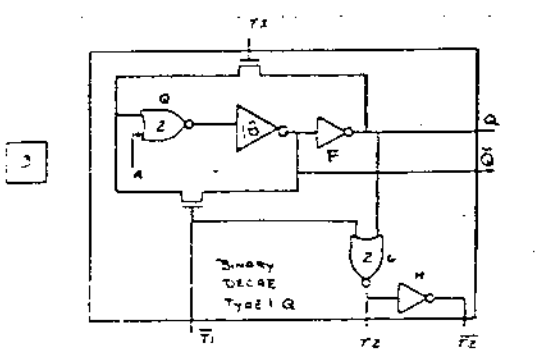
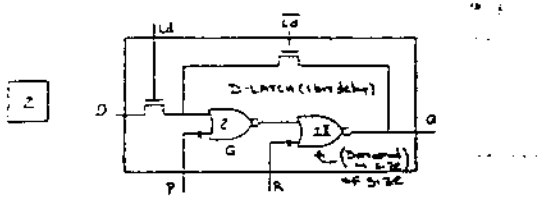
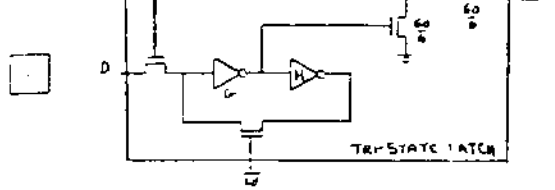

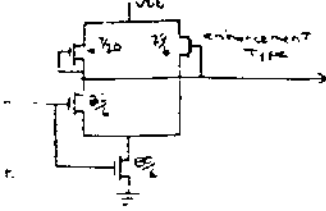

Keyboard CONTROL PLA, PAGE 2

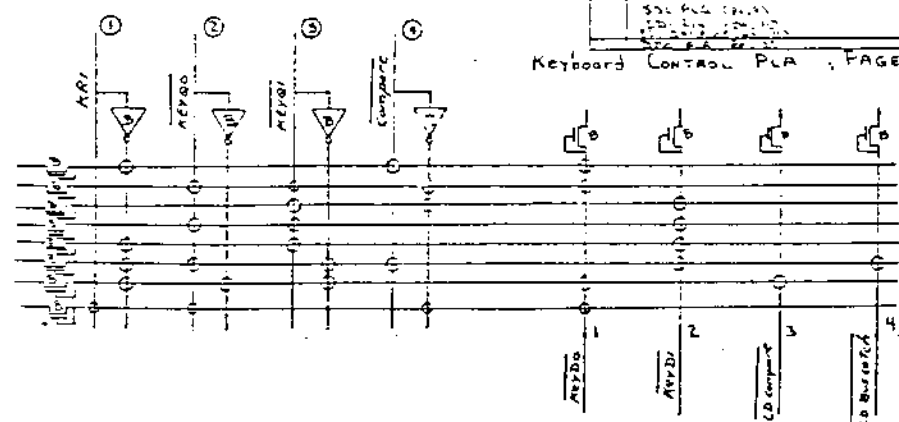

SERIAL DATA IN PLA, PAGE 5

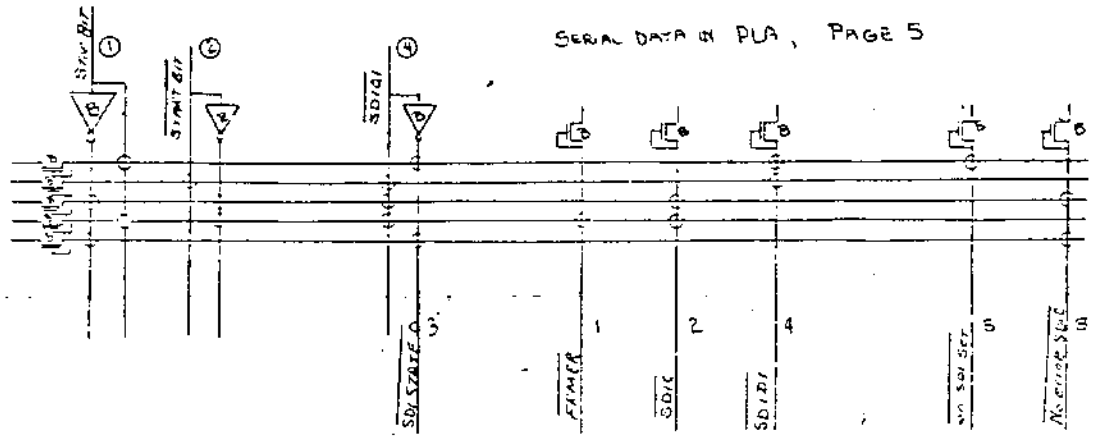

SERIAL DATA OUT PLA, PAGE 5

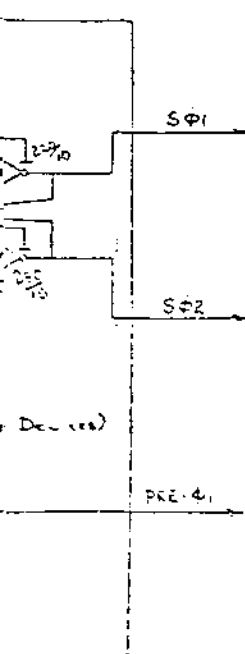
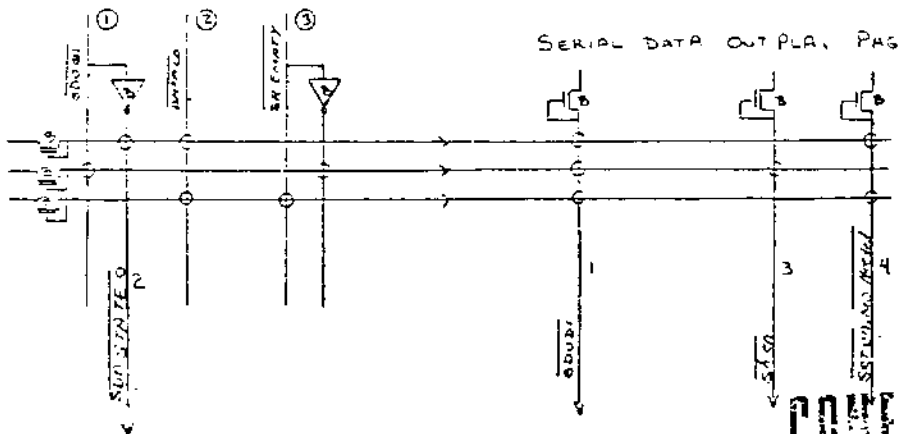

CONFIDENTIAL

OUTSTANDING ECNs

UNLESS OTHERWISE SPECIFIED DIMENSIONS ARE IN INCHES TOLERANCES ON:		DO NOT SCALE DRAWING		ATARI INC. 1255 Rompage Avenue Sunnyvale, Calif. 94088 A Member Company of the Atari Corporation
ANGLES: ± 1°	SURFACE FINISH:	DRAWN BY:	DATE:	
MATERIAL:		CHECKED:	TITLE:	FILE NO. D DRAWING NO. CO12294
FINISH:		SAMPLE:	PROJECT: EST 484	
NOTE TO ALL: THIS DRAWING IS THE PROPERTY OF ATARI INC. AND IS TO BE KEPT CONFIDENTIAL. IT IS TO BE USED ONLY FOR THE PROJECT AND NOT TO BE REPRODUCED OR COPIED IN ANY MANNER WITHOUT THE WRITTEN PERMISSION OF ATARI INC.		PROJECT MONITOR:	SHEET NO. B OF 3	SHEET NO. B OF 3

DRAWING NO. **CO12294**
 SHEET **41** OF **B**

C

B

A

4

3

2

1

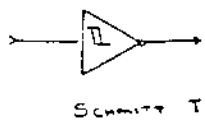
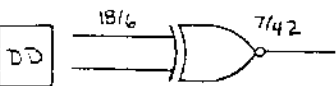
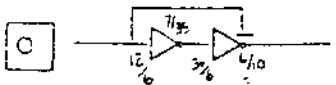
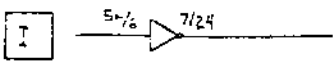
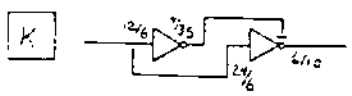
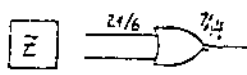
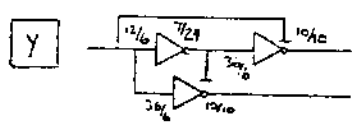
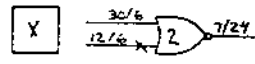
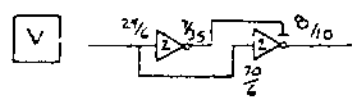
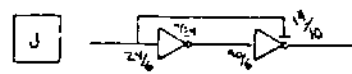
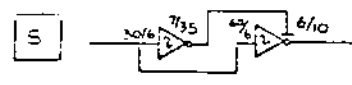
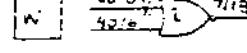
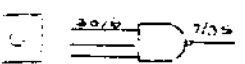
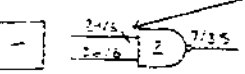
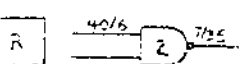
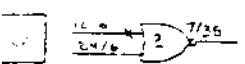
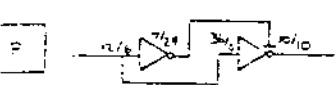
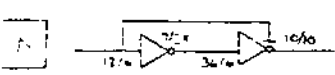
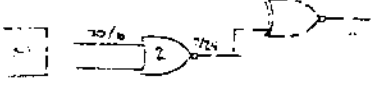
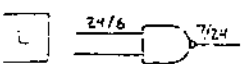
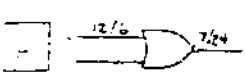
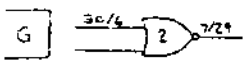
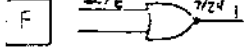
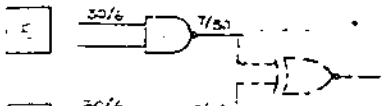
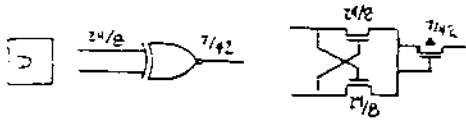
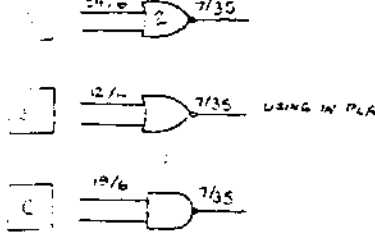

INDICATES NO COUPLER ON THIS INPUT.

NOTE:

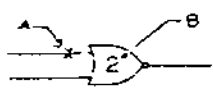

A X INDICATES NO COUPLER ON THAT INPUT.
 3 NUMBER INDICATES CLOCK PHASE OF INPUT COUPLERS.

